



CATALOG 2023

HIND RABII
LIGHTING STUDIO



« Love is a word of light
written by a hand of
light
upon a page of light »

Kahlil Gibran, Lebanese poet

THE
STUDIO

Sensitive and emotional manufactures.



HIND RABII IS DEVOTED TO SHEDDING LIGHT ON HIS LETTERS OF EMOTION.

Since 1997, the designers Hind Rabii and Michel Orban both industrial engineers have a common passion and love for creation, design and innovation.

We expect lights to shed light, to shine, to create shadows. To do this, the poetry of materials, glass, wood, gold and silver leaf, colours used by HIND RABII, positively alter the realities for playing the emotions card without indifference.

Because here is the poetic message of filters, colours, blended reflections, transparency that appears to make every HIND RABII model appeal to the desire of love and of light.

And today we still have, a need for these words cast on a page of white vellum.

Like you, we imagine that the HIND RABII brand is and will be synonymous with all these terms that are only language.

This language which skillfully builds itself in front of the manufactures that are glass blowing, confection of lampshades, wood, aluminum and steel work. All these trades that HIND RABII manages to show only the essentials.

As the Lebanese poet Kahlil Gibran writes, the writing of a hand of light, on a page of light is the vision of light that we offer.



A HANDCRAFT WORK MADE
BY ITALIAN ARTISANS WITH
ANCESTRAL KNOWLEDGE
OF THE MATERIAL AND THE
METHOD.





MOUTH BLOWN GLASS
MADE IN MURANO,
COLORED IN MASS, A
UNIQUE ITALIAN KNOWHOW.

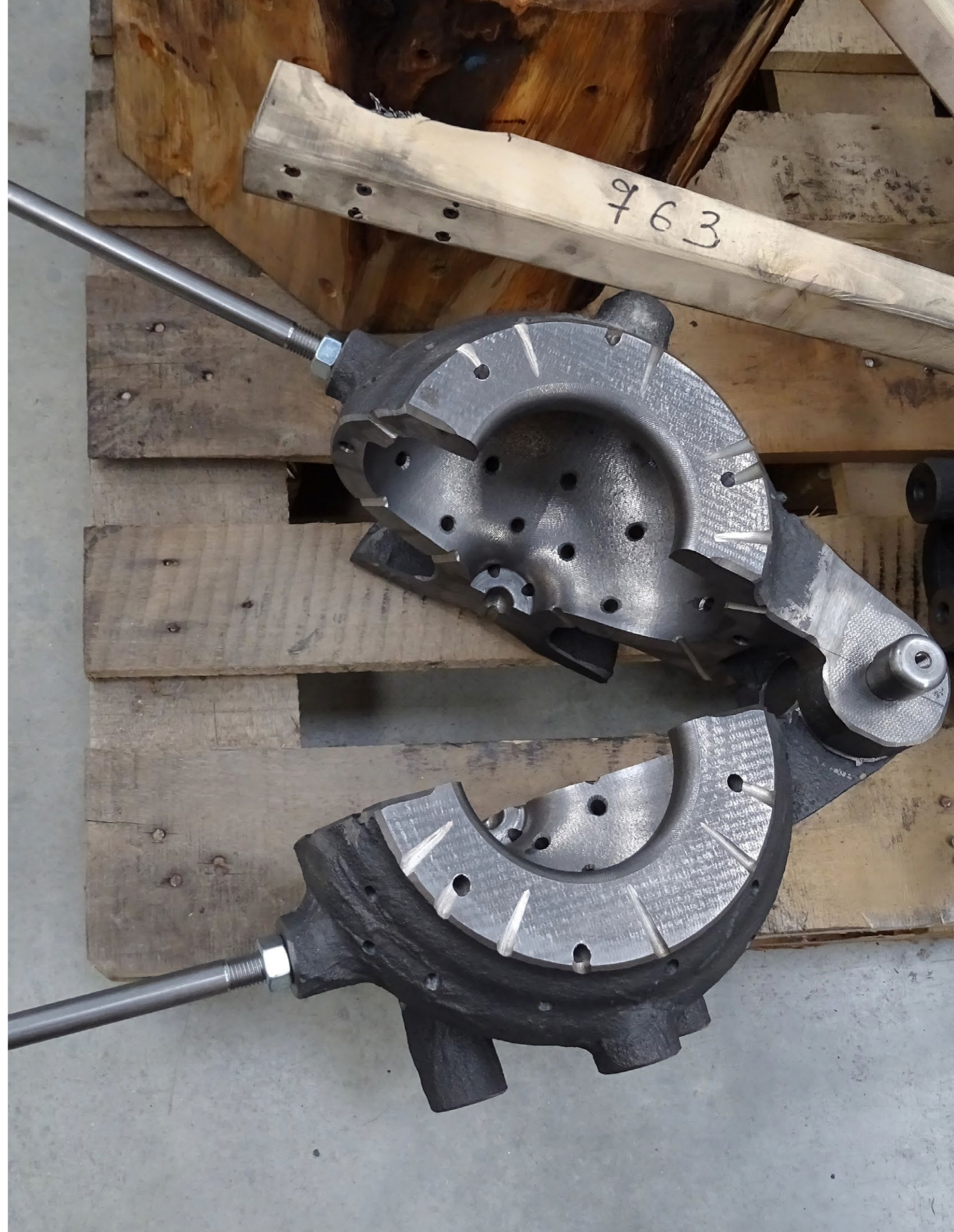

01-
INFINITY
by Chiaramonte-Marin Studio
/ 2021



Product p.28
Technicals p.37

02-
**HALF &
HALF**
by Alain Gilles / 2021



Product p.40
Technicals p.47-53

03-
OASI
by Chiaramonte-Marin Studio
/ 2021

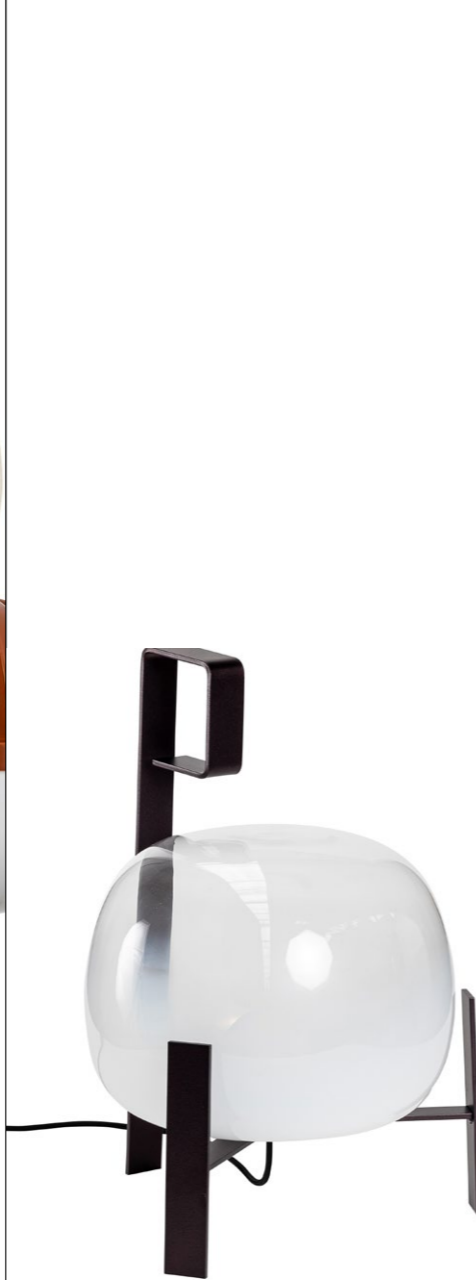

Product p.56
Technicals p.63

04-
TREZERO
by Alberto Nason / 2022



Product p.65
Technicals p.69

05-
T-COTTA
by Chiaramonte-Marin Studio
/ 2018



Product p.71
Technicals p.77-81-89

06-
MERIDIANA
by Chiaramonte-Marin Studio
/ 2018



Product p.91
Technicals p.95-103

07-
FICO
by Hind Rabii / 2018



Product p.104
Technicals p.111

08-
DISCA
by Alberto Nason / 2017



Product p.113
Technicals p.121

09-
YA-YA
by Hind Rabii / 2017

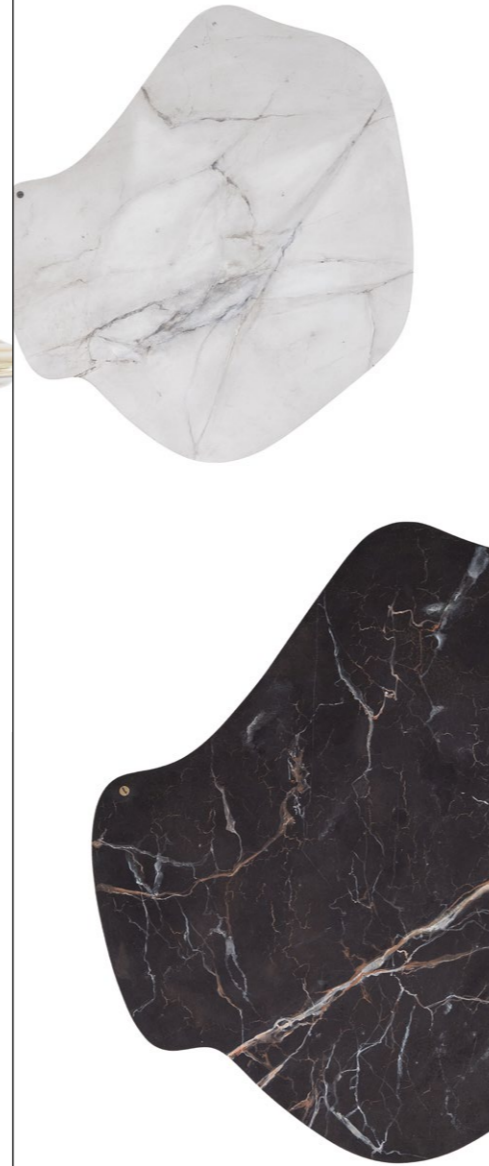

Product p.123
Technicals p.129

10-
ICE ABSOLUT
by Hind Rabii / 2015

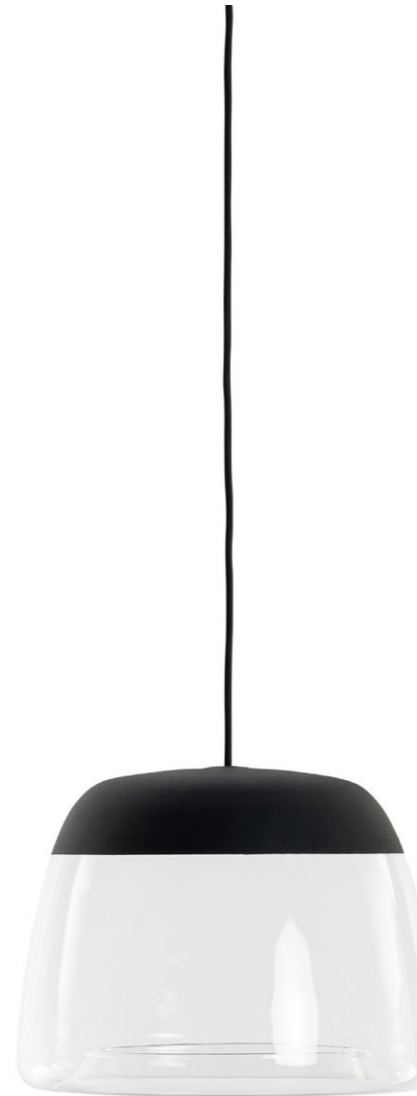

Product p.131
Technicals p.137

11-
ESPRIT YA-YA
by Hind Rabii / 2017



Product p.138
Technicals p.143

12-
ANNA BELLE
by Hind Rabii / 2017



Product p.145
Technicals p.149

13-
NEWELS
by Hind Rabii / 2014



Product p.151
Technicals p.155

14-
3X3X3
by Hind Rabii / 2014

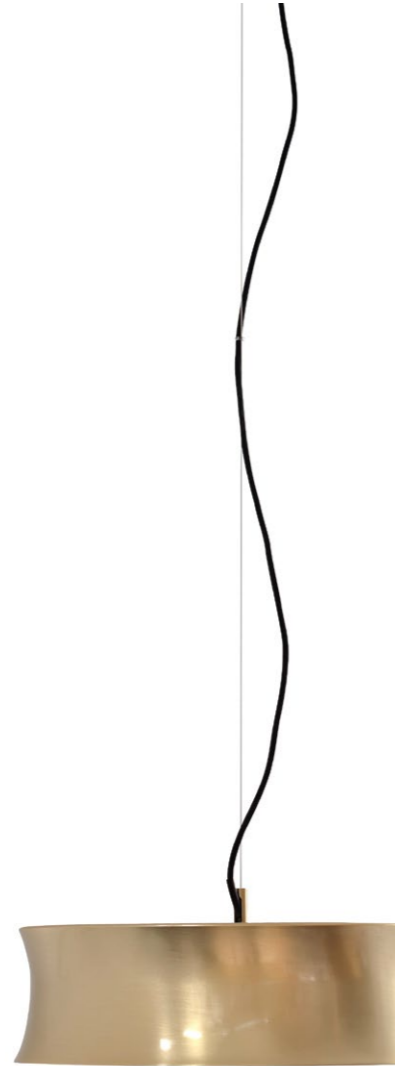

Product p.157
Technicals p.161-165

15-
**TENUE DE
SOIRÉE**
by Hind Rabii / 2015



Product p.167
Technicals p.173

17-
OND'A
by Hind Rabii / 2018

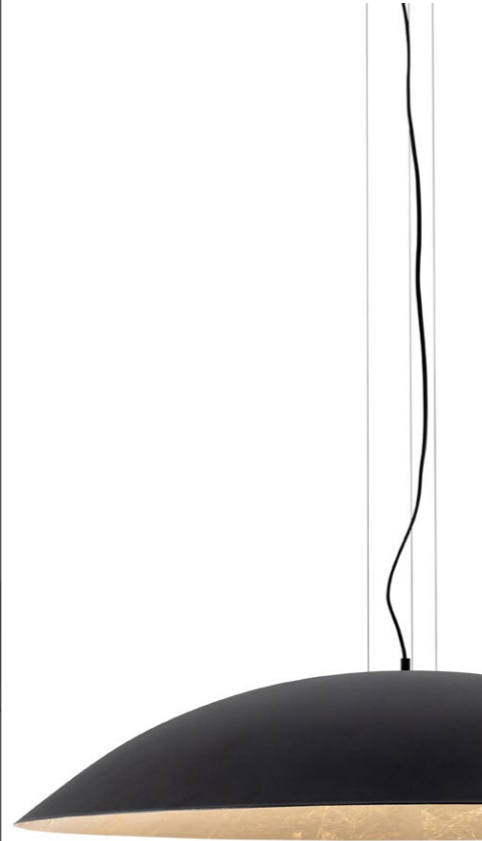

Product p.175
Technicals p.179

16-
ICE
by Hind Rabii / 2017



Product p.181
Technicals p.185

18-
REFLECTORS
by Hind Rabii / 2014



Product p.191
Technicals p.197-201



BESPOKE

As manufacturers, most of our designs could be customised for special projects. Any cable height, colors, finishes or even dimensions may be on measure.

Our design office will help architects and interior designers for any bespoke project. We developed also a complete range of hanging solutions to fit into projects with special specifications. Any project could be studied by us to suggest the best we can. We developed canopies for single hanging lamps but also for small or even big combinations.

For any special project: office@hindrabii.com
 From Belgium to the world.

LEXICON :

All dimensions on technical drawings are in mm

K : Kelvin (light temperature)

lm : lumens (luminous flow)

Phase-cut dim. : dimmable with a phase-cut dimmer (standard on all products)

GOOD TO KNOW ABOUT DIMMING :

PHASE-CUT DIMMING.

All our products are delivered and tested with analog phase-cut dimming capability.

DALI

For most situations phase-cut dimming is the right way but for new projects for your modern home or for hospitality projects you may need the digital standard DALI. We also provide on request led drivers for DALI system, contact us !

CASAMBI

Use your phone as a switch or dimmer.

We provide the good solution with the Casambi system. Ask for it !

THE
COLLECTIONS

The poetry of materials



Create an object that has no limits, that cannot have a conclusion.

01

INFINITY

Design by Chiaramonte-Marin / 2021

Create an object that has no limits, that cannot have a conclusion because precisely, without end. Infinity, is definitely the contemporary and timeless tripod light, as an object of our life that has no need to be reinvented.





THE DESIGNERS

Infinity, as soon as it was launched, receives design awards from Italy and Germany. Here a presentation of the designers who made this particular and timeless floor lamp. A spirit and inspiration from the past for a long future.



CHIARAMONTE ALFREDO&MARCO MARIN DESIGN

The passion for objects meant as industrial products is the glue of the professional partnership between Alfredo Chiaramonte and Marco Marin, promoting partners of the homonymous Designstudio.

The different activities experienced through the years (interiors, graphics, industrial and lighting design) brought to a mixed knowledge, contaminated by ideas developed in many fields.

Alfredo Chiaramonte was born in Bologna and studied at the Faculty of Architecture of Venice. Marco Marin was born in Venice and graduated at the Academy of Fine Arts specializing in industrial design.

They worked together with well known furniture and lighting companies.

They taught at the European Center for preservation of the architectural heritage in Venice.

Through the years they received many recognitions and some of their works have been exposed in the permanent collections of International Museums, like Museo Correr in Venice, Beaubourg in Paris, Design Museum of Calenzano (Anna Querci Foundation) Moma in San Francisco and the Venice Biennale when they worked with Yoko Ono.



Infinity galvanic black
Infinity bronze



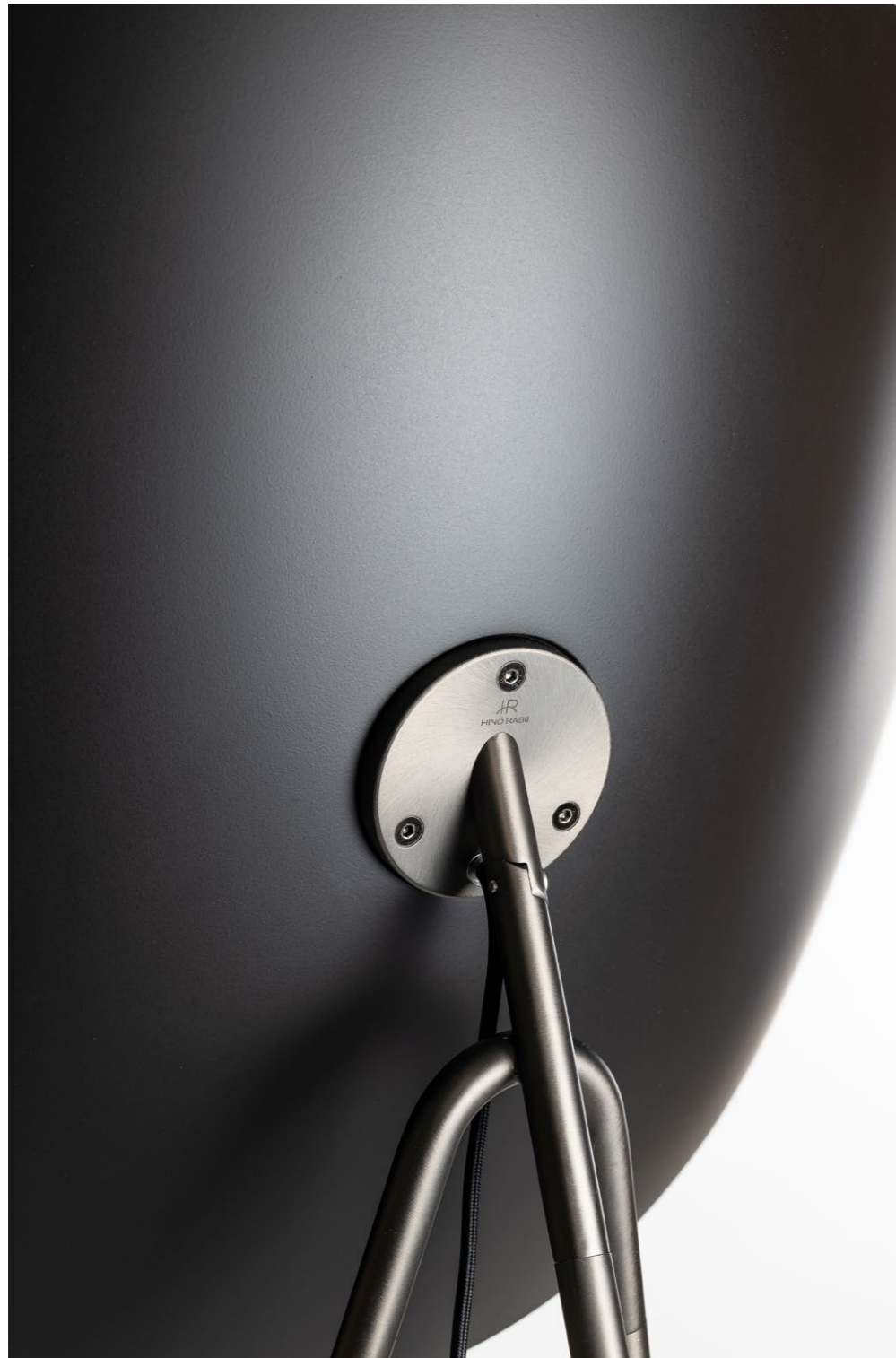

Infinity Galvanic black

INFINITY

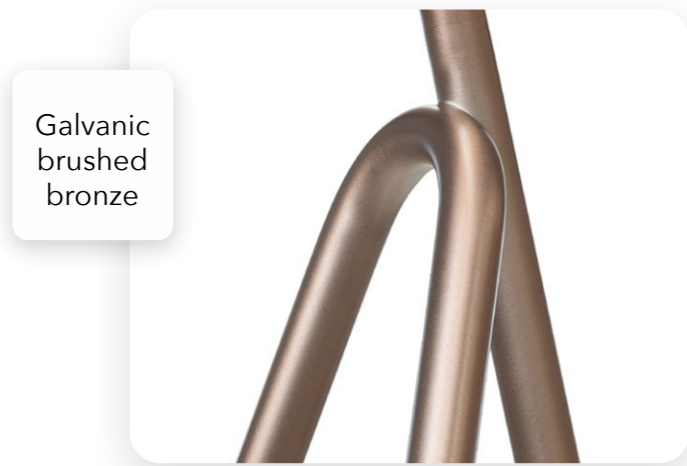
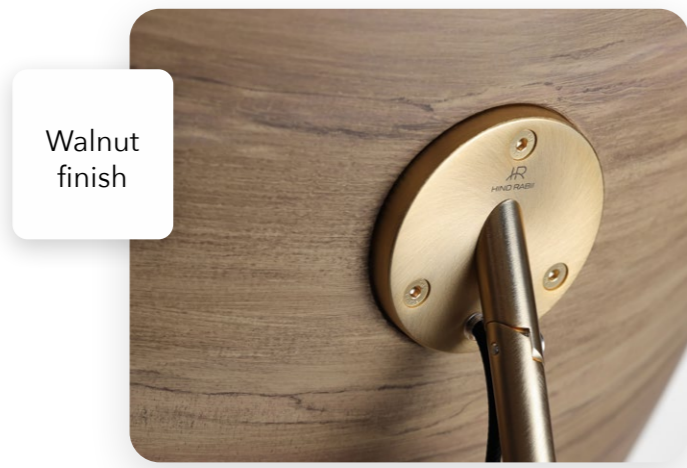

INFINITY

LAMPSHADES



Matt black

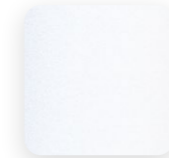

Matt white

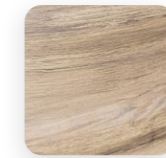

Walnut

STRUCTURE

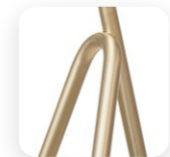

Brushed gold

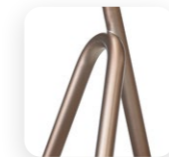

Brushed bronze

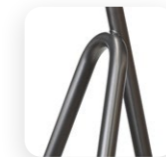

Brushed black

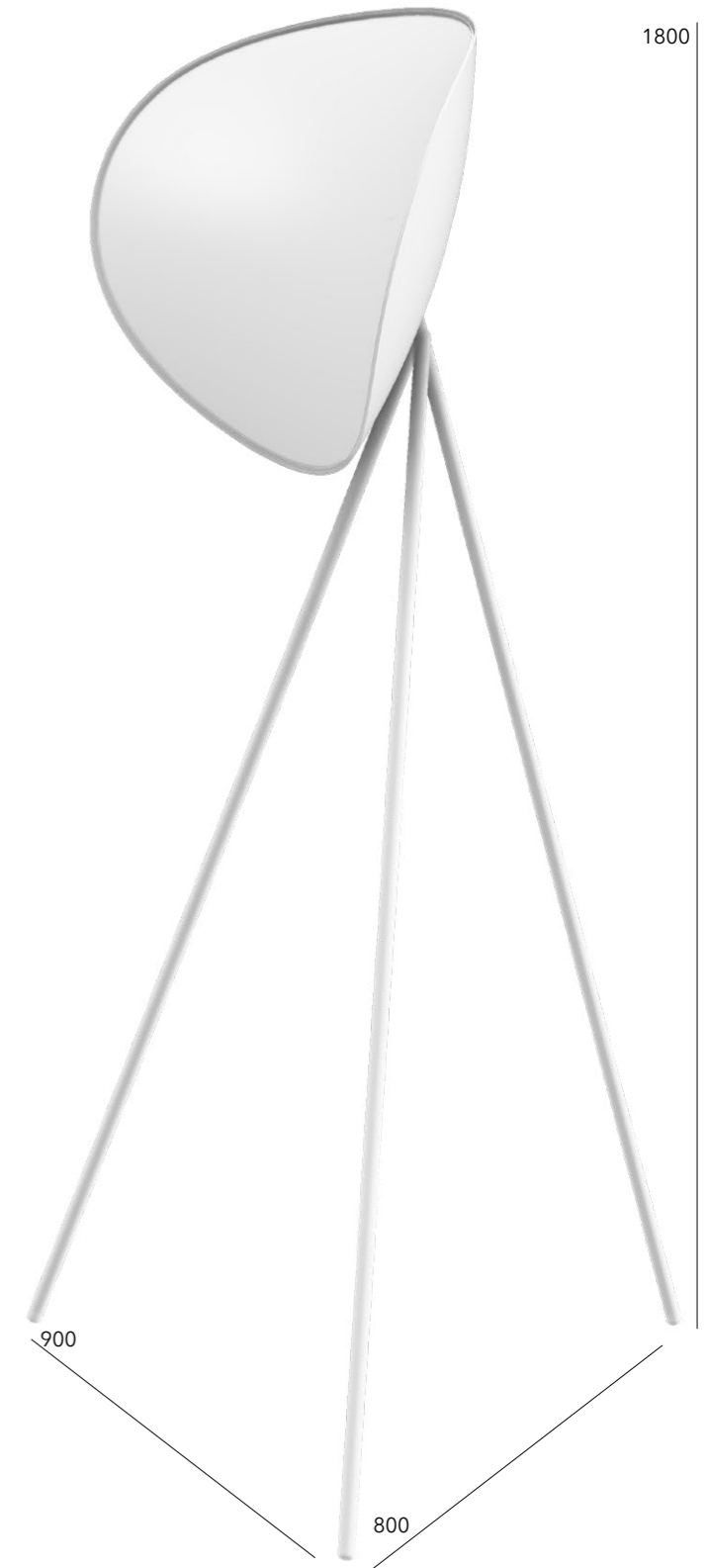

TECHNICAL

-INFINITY
IP20 led COB 16w
2700K 2600 lm
Cable plug with dimmer switch.



HALF & HALF

Design Alain Gilles / 2021

The perception of a material would almost always appear different as the daylight changes with time, or when the light is lit in the evening.

02

HALF&HALF

Design by Alain Gilles / 2021

Create an object that has no limits, that cannot have a conclusion because precisely, without end. Infinity, is definitely the contemporary and timeless tripod light, as an object of our life that has no need to be reinvented.





Half&Half L Toscan
Half&Half S Smooth



Half&Half L Caviar

HALF&HALF

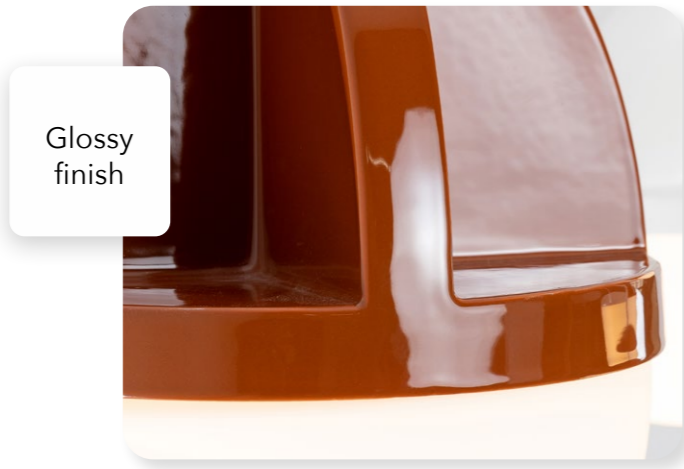

HALF&HALF

CERAMIC



Caviar



Green



Smooth



Toscan

GLASS



Opal white

TECHNICAL

-HALF&HALF S
IP20 G9 led bulb 2 x 5w
2700K 700 lm
Phase-cut dimming

-HALF&HALF L
IP20 G9 led bulb 3 x 5w
2700K 1050 lm
Phase-cut dimming

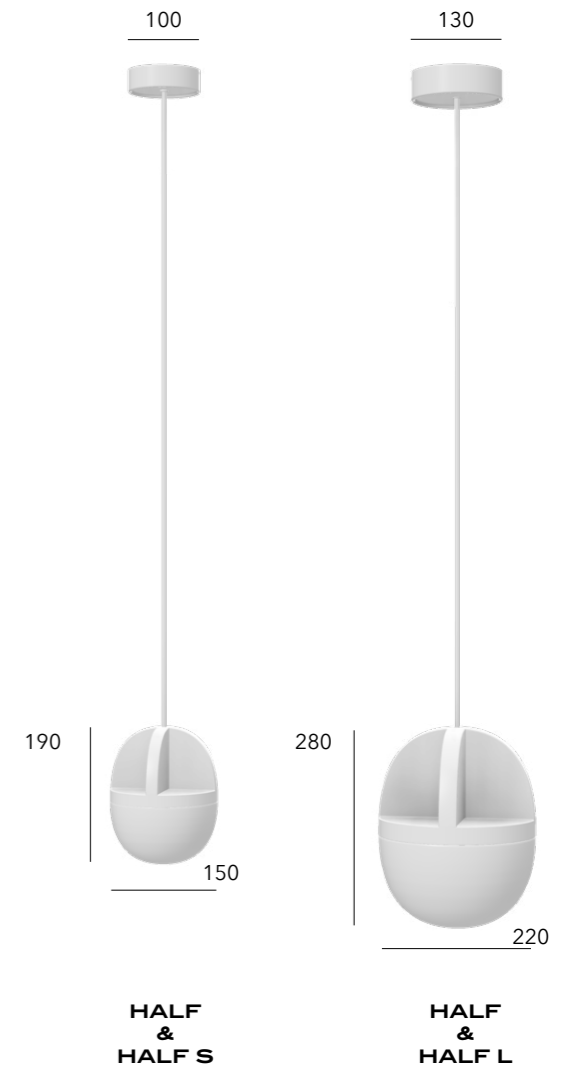





Half&Half wall
Smooth-Green-Toscan



HALF&HALF WALL

Glossy finish



Smooth off white



HALF&HALF WALL

CERAMIC



Caviar



Green



Smooth



Toscan

GLASS



Opal white

TECHNICAL

-HALF&HALF WALL S
IP20 G9 led bulb 2 x 5w
2700K 700 lm
Phase-cut dimming.

800



445

HALF & HALF WALL

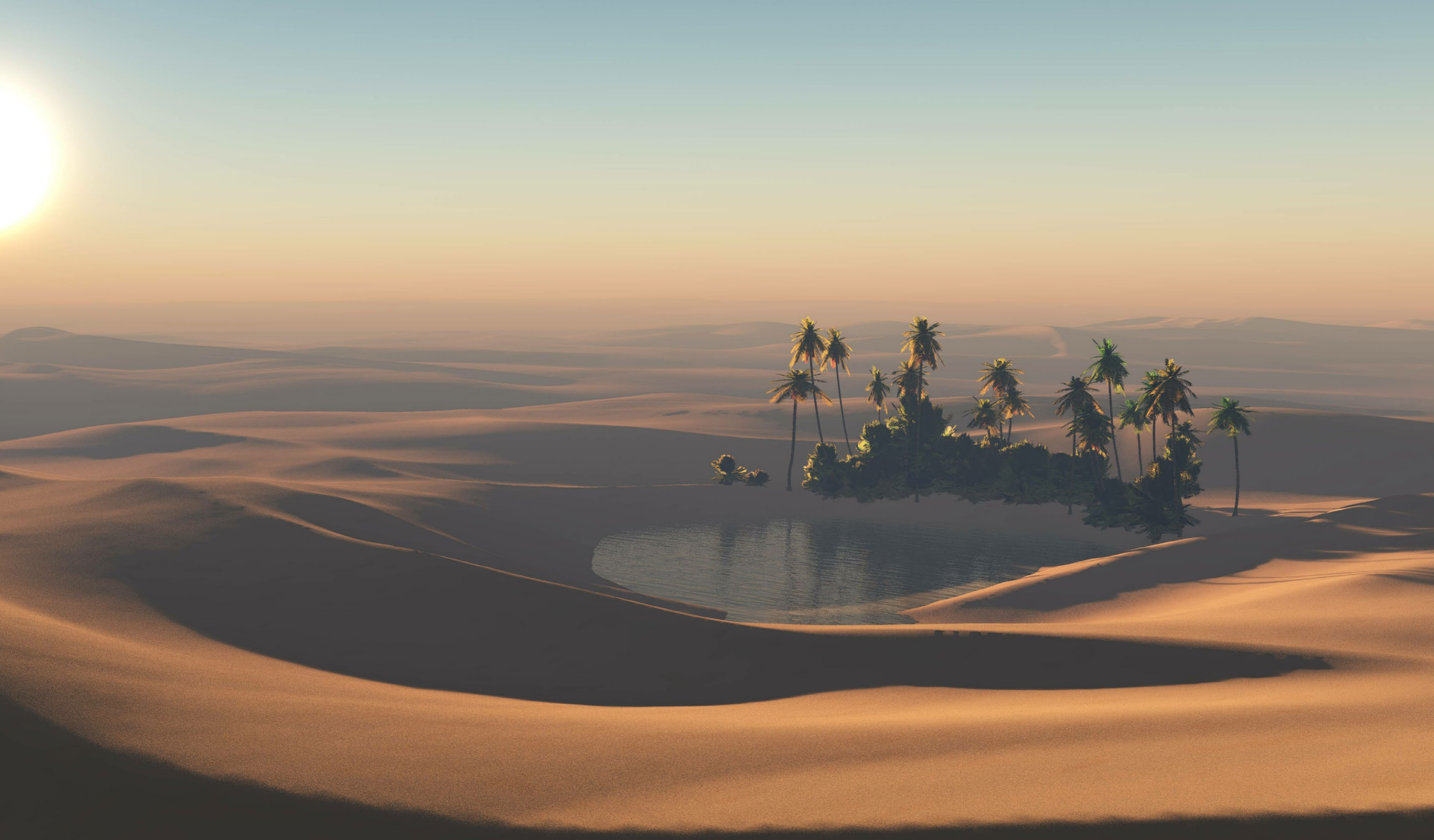

Oasi...fantastic animals transformed into bright objects created to stand under the sky.

03

OASI

Design by Chiaramonte-Marin / 2021

Fantastic animals transformed into bright objects created to stand under the sky.

Oasi comes with a base in stainless steel, finished with fine outdoor powder and mouth Italian blown glass.

Combination of colors, inspired by the earth as this Ourika color, name of red valley in south Marrakech







Oasi S uva nera-sfumato

OASI



STRUCTURE

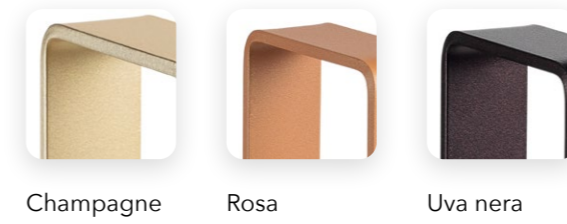

GLASS



TECHNICAL

- OASI S
IP44 G9 led bulb 2700K 400 lm
- OASI MA
IP44 G9 led bulb 2700K 400 lm
- OASI MB
IP44 G9 led bulb 2700K 400 lm
- OASI L
IP44 G9 led bulb 2700K 400 lm

OASI

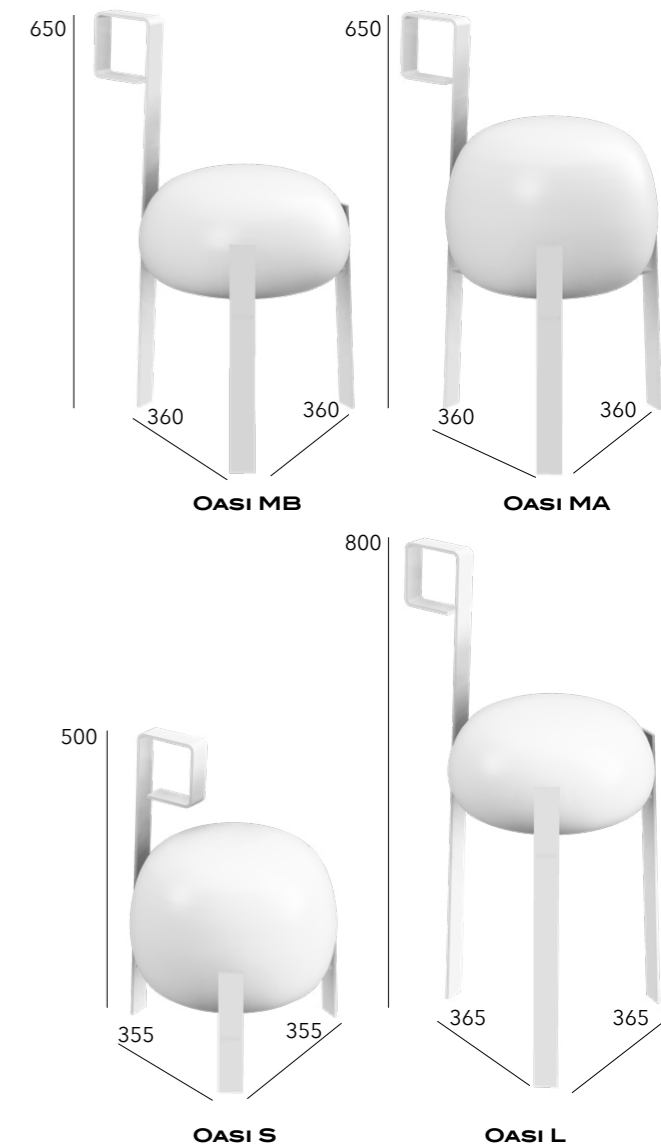

O4

TREZERO

Design by Alberto Nason / 2022

Trezero is the last design from the Italian designer Alberto Nason. Reinterpretation of classical -Lustre- with 3 big glass discs handmade in Italy. The special technic of the glass is called Vetro Lastra. back light going directly on the glasses and





TREZERO

Handmade glass



Back light detail



STRUCTURE



Matt black

GLASS



Opal white

TECHNICAL

-TREZERO
Led module 3x7w 2700K 3500 lm
Phase-cut dimming.

TREZERO

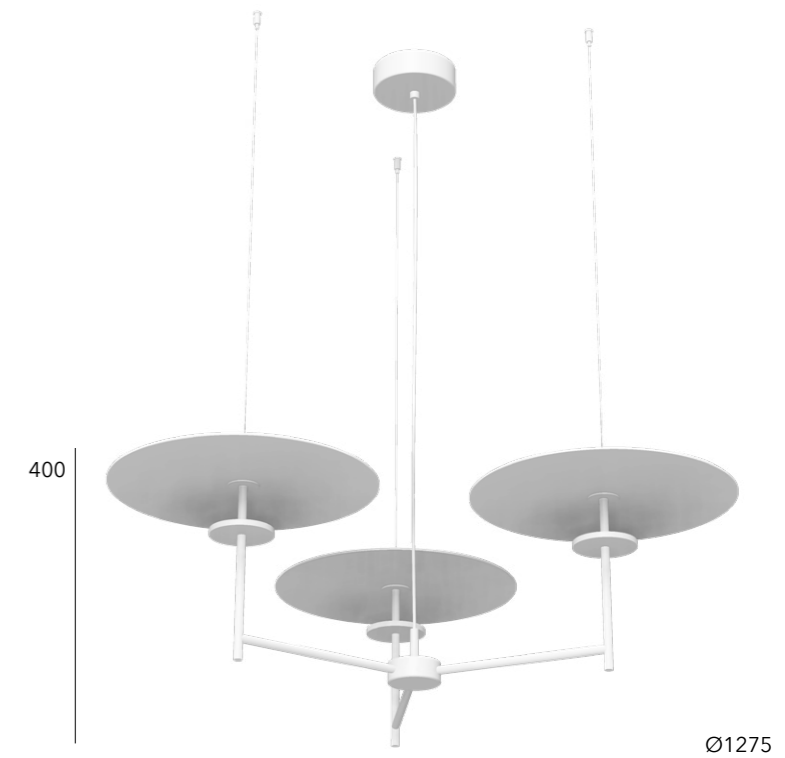

TREZERO

05

T-COTTA

Design by Chiaramonte-Marin / 2018

Created from the desire to create an object of fluid, curved forms, T-COTTA is the fruit of the union of materials, both of which come from earth, both are worked by man and both forged by heat.





TC4 Terracotta-opal white
 TC1 Terracotta-opal white



TC1 Grey-cristal
 TC3 Grey-cristal



TC1 Smooth-opal white
TC2 Smooth-opal white



TC4 Black diamond-cristal
TC1 & TC2 Black diamond-cristal

T-COTTA



Natural ceramic



Detail on glossy ceramic

T-COTTA

CERAMIC

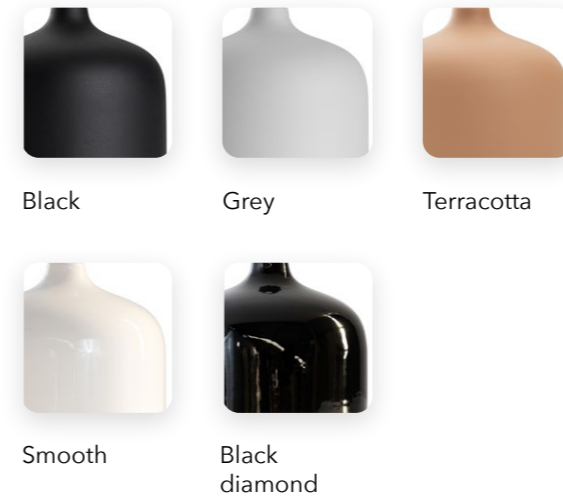

GLASS



TECHNICAL

- T-COTTA TC1**
IP20 module led 8W 2700K 1200 lm
- T-COTTA TC2**
IP20 module led 8W 2700K 1200 lm
- T-COTTA TC3**
IP20 module led 8W 2700K 1200 lm
- T-COTTA TC4**
IP20 led module 23W 2700K 3000 lm

Phase-cut dimming.

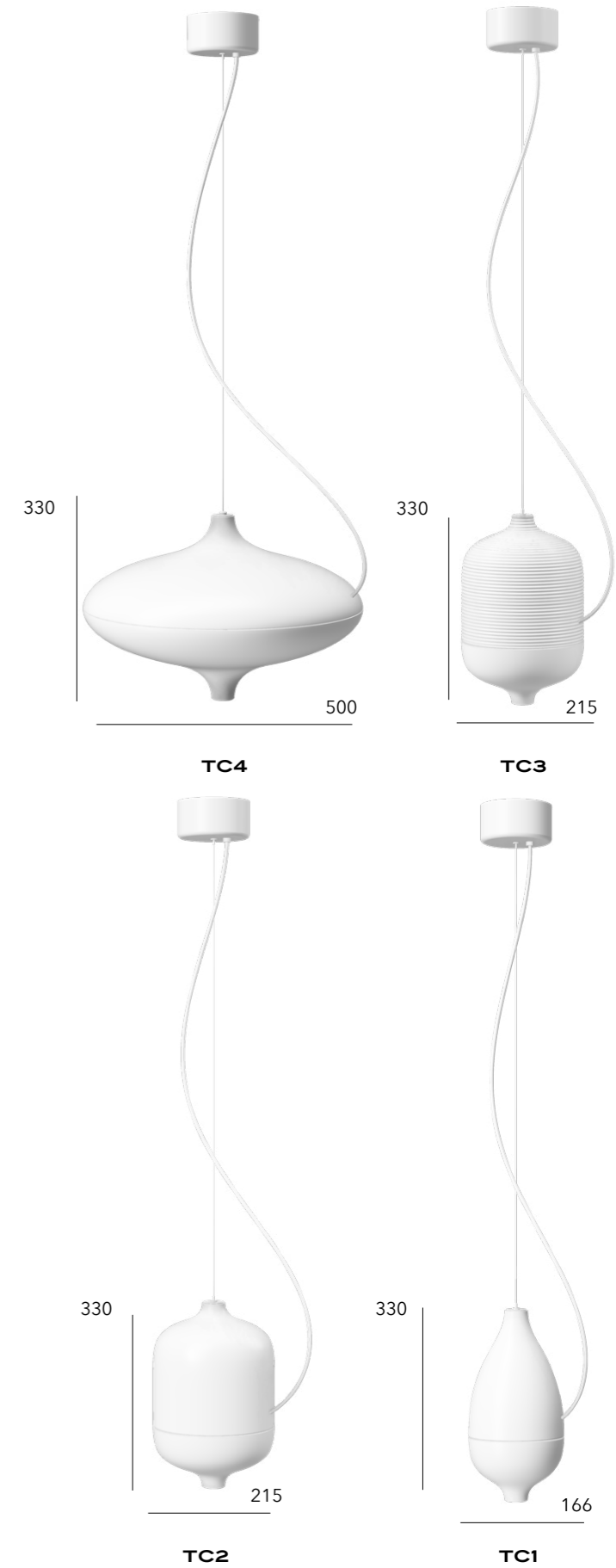

T-Cotta wall comes naturally in this collection as a wall or ceiling lamp, the source is invisible, discreet but efficient. the front glass comes in different finishes but always with this ceramic precious structure.



T-COTTA WALL



T-COTTA WALL

GLASS FINISH



Matt black Grey Terracotta Pink Green



All opal white



Smooth



Black diamond

TECHNICAL

T-COTTA WALL
IP20 Led Module 8W 2700K 1000 lm
Phase-cut dimming.

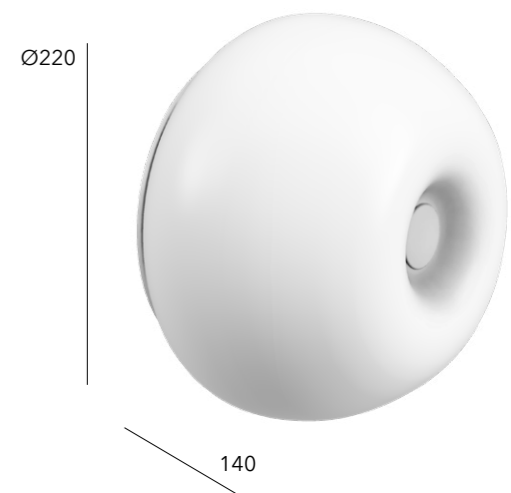

T-COTTA WALL







T-COTTA THE LAMP

Black
chrome on
solid brass



Smooth
pink finish



T-COTTA THE LAMP

GLASS FINISH

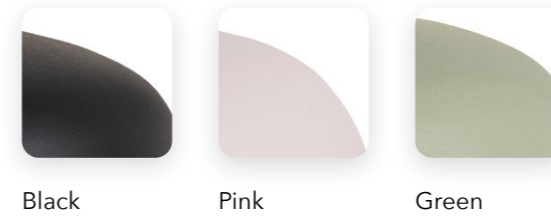

Black

Pink

Green

MARBLE



Nero
marquina

White
carrara

TECHNICAL

- T-COTTA TS**
Led module 12w 2700K 1500 lm
- T-COTTA TM**
Led module 12w 2700K 1500 lm
- T-COTTA FL**
Led module 12w 2700K 1500 lm

Cable plug with dimmer switch.

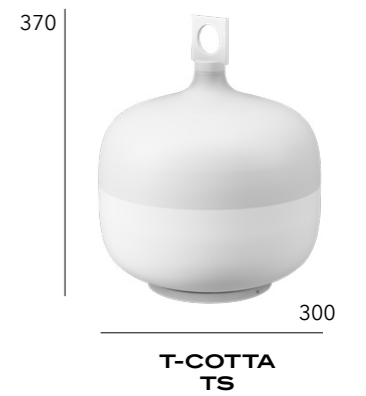

**T-COTTA
TS**

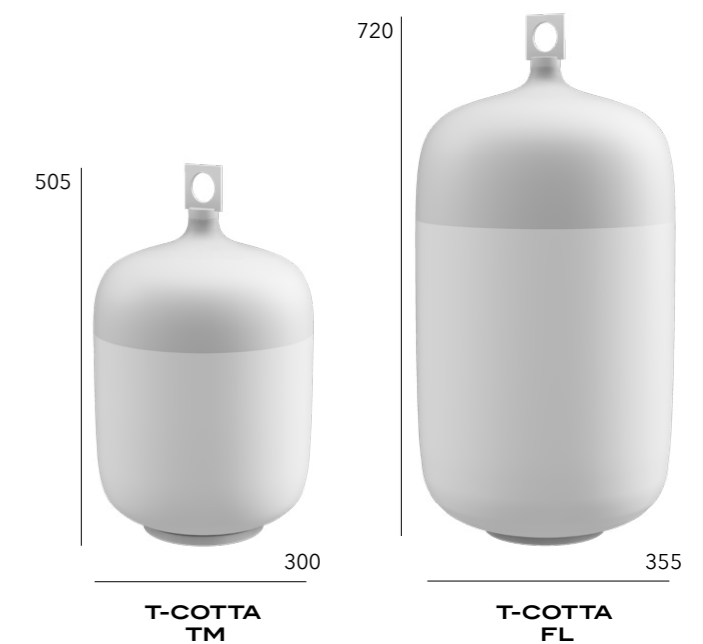

**T-COTTA
TM**

**T-COTTA
FL**

06

MERIDIANA

Design by Chiaramonte-Marin / 2018

Meridiana: this is not a sundial.
The process in fact is inverse: here the light is not the means, but the purpose, a great disk like the sun and hidden behind a big clock hand or what it seems like, a gentle and smooth not blinding light.



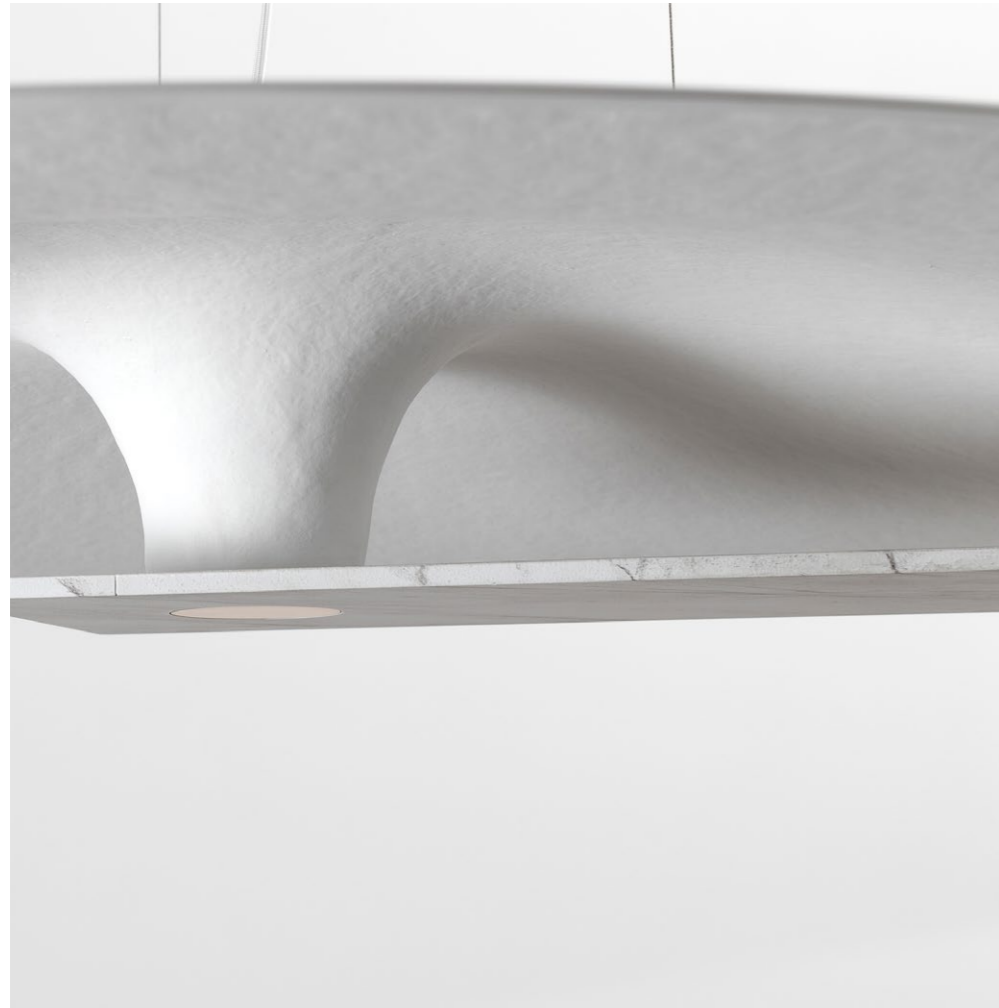

MERIDIANA

Special structure

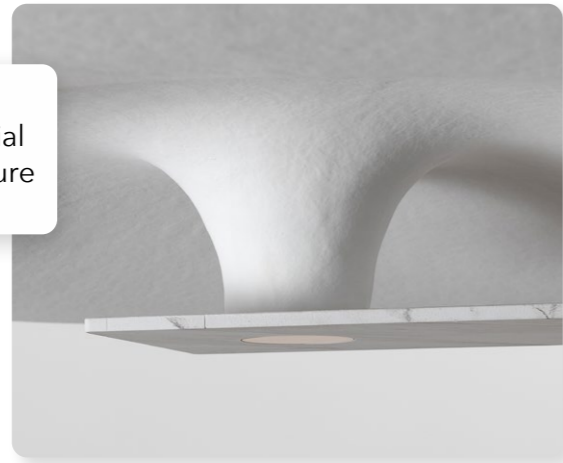

Fiberglass work



MERIDIANA

SHADE

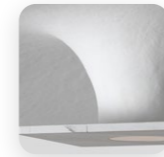

Matt white

DIFFUSOR

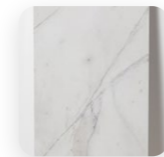

White marble

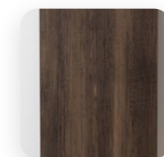

Wengé oak

TECHNICAL

-MERIDIANA S & MERIDIANA S CEILING
IP20 led module 9w 2700K 1500 lm

-MERIDIANA L & MERIDIANA L CEILING
IP20 led module 45w 2700K 5000 lm

Phase-cut dimming.



Ø700

MERIDIANA CEILING S



Ø700

MERIDIANA S



Ø1100

MERIDIANA CEILING L



Ø1100

MERIDIANA L





Meridiana ceiling L



Meridiana floor

MERIDIANA

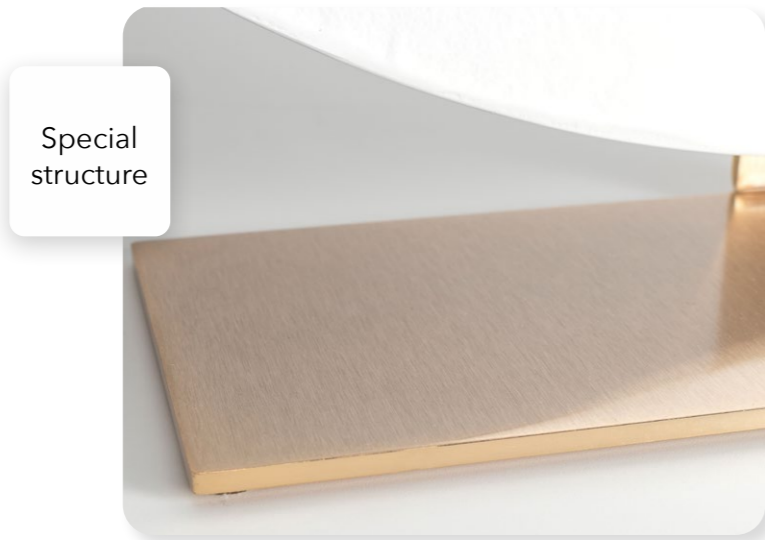

MERIDIANA

SHADE

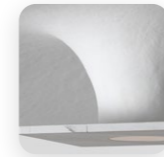

Matt white

DIFFUSOR

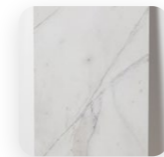

White marble

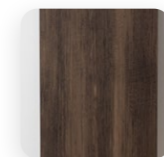

Wengé oak

TECHNICAL

-MERIDIANA WALL- L
IP20 led module 35w 2700K 4000 lm

-MERIDIANA FLOOR
IP20 led module 35w 2700K 4000 lm

Phase-cut dimming.

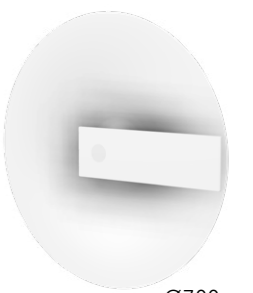

Ø700

**MERIDIANA WALL
S**

Ø1100

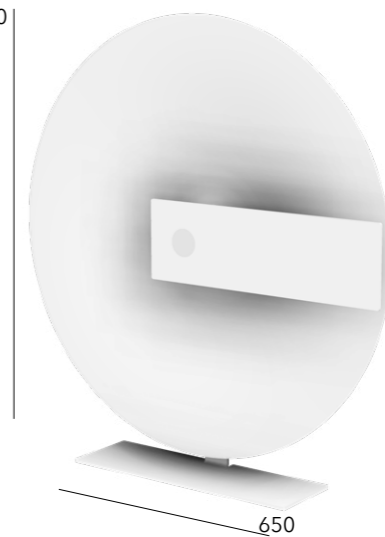

650

MERIDIANA FLOOR

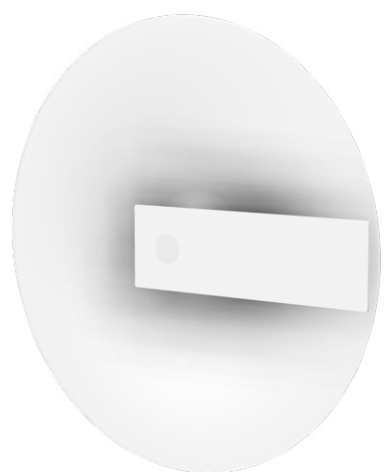

Ø1100

MERIDIANA WALL

07

FICO

Design by Chiaramonte Marin Studio / 2018

Like the fruit of the same name (FIG in Italian), which conceals succulent pulp beneath a thick skin, here the light is protected by a shell of ceramic hanging from a tape as if from the branch of its tree. It comes in three different shapes.



Fico 1 White
Fico 2 White
Fico 3 White



Fico 1 Black





FICO

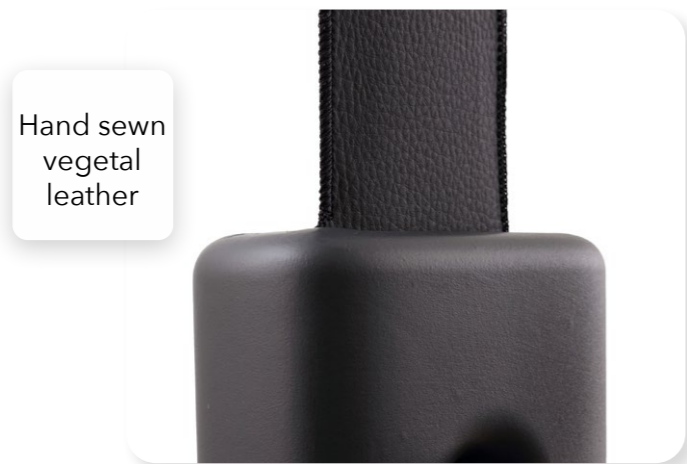

FICO

CERAMIC

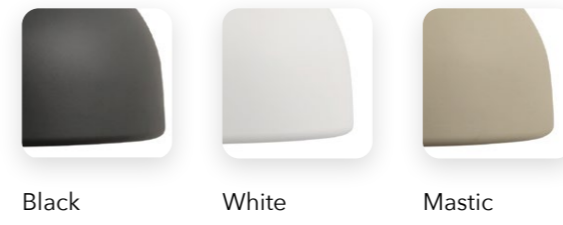

BELT FINISHES



TECHNICAL

- FICO 1 - FICO 2 - FICO 3
IP20 E27 led bulb 13w 2700K 1100 lm
Phase-cut dimming.

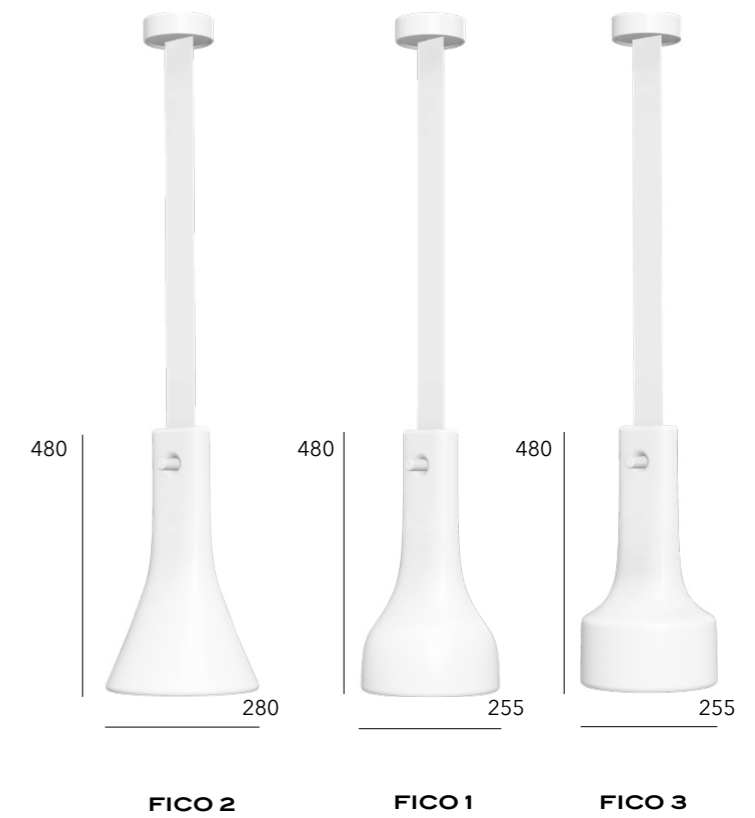

08

DISCA

Design by Alberto Nason / 2017

Sometimes a luminous apparition seems to come from elsewhere. In green, transparent white, milky or transparent lava glass, DISCA expresses itself fully in any defined or virtual place.

Its flashes of light carry its shapes off to infinity, as they spin on themselves in a Venetian vortex or a Viennese Waltz.





Disca S Cristal-fumé blue



Disca S Opal white-white



Disca T Amber-Wengé





Disca green makes light integrate nature, playing with reflection on this special mouth blown glass.

DISCA



Amber color in mass

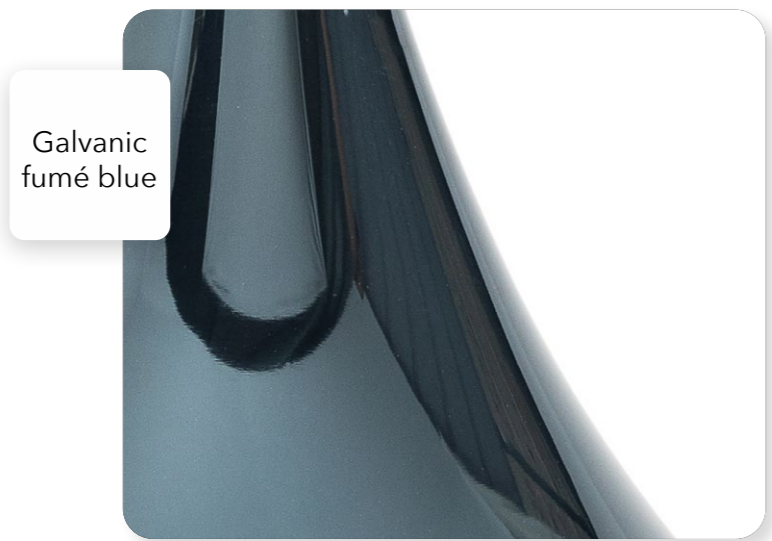

Galvanic fumé blue

DISCA

GLASS FINISH



Amber

Opal white

Green

Cristal

CAP

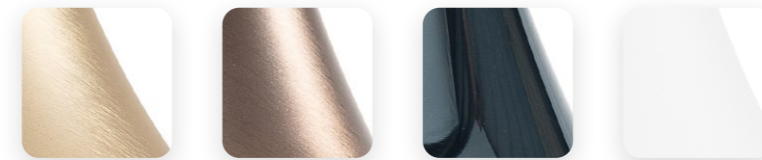

Brushed gold

Brushed bronze

Fumé blue

Matt white

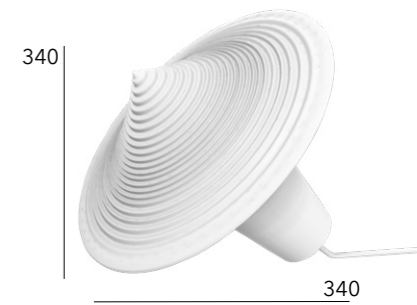

DISCA T

TECHNICAL

-DISCA S
IP20 led module 8w 2700K 800 lm

-DISCA L
IP20 led module 8w 2700K 800 lm

-DISCA T
IP20 E27 led bulb 6w 2700K 600 lm

Phase-cut dimming.

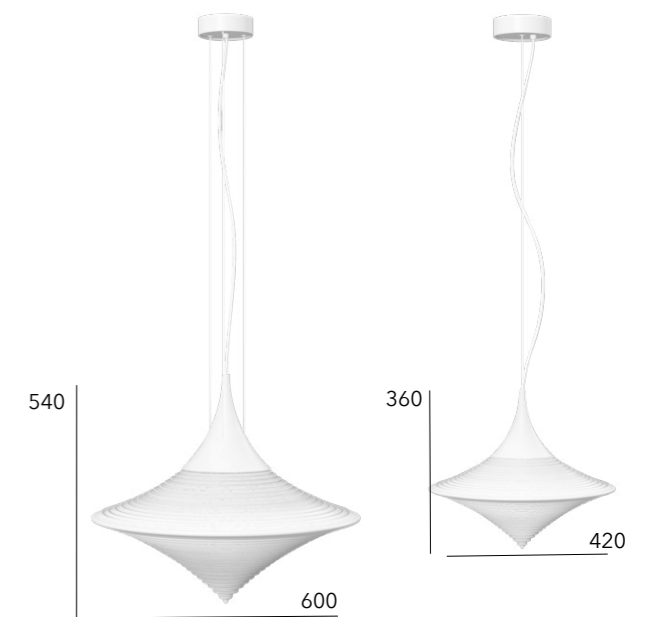

DISCA L

DISCA S

09

YA-YA

Design by Hind Rabii / 2017

YA-YA is determined to be at the centre, at the heart of places, a long fresco or hooked on modest surfaces.

Its lights are all in suggestive and subtle mother-of-pearl corollas.





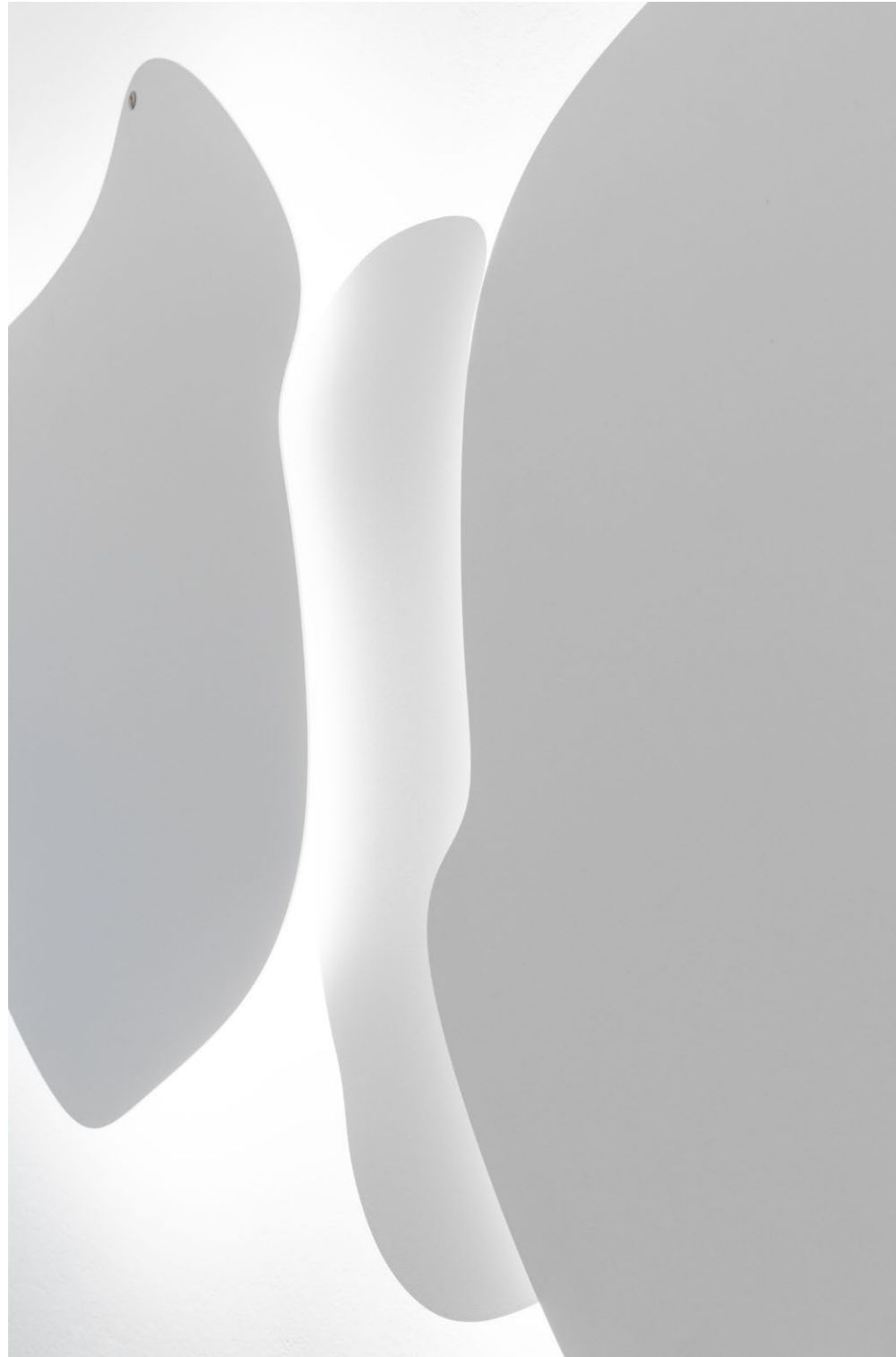

YA-YA

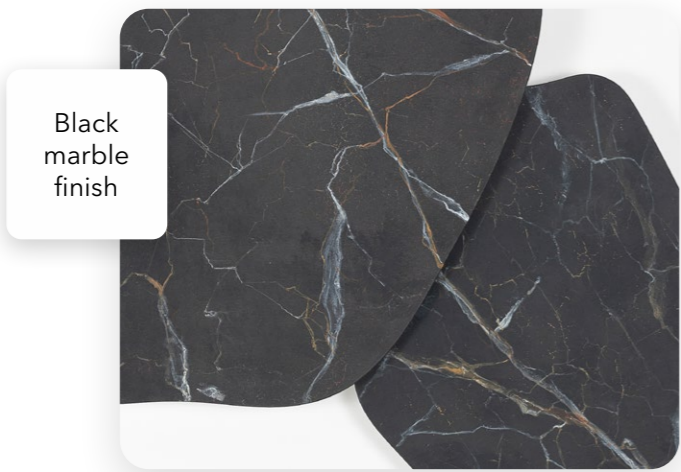

YA-YA

FINISHES

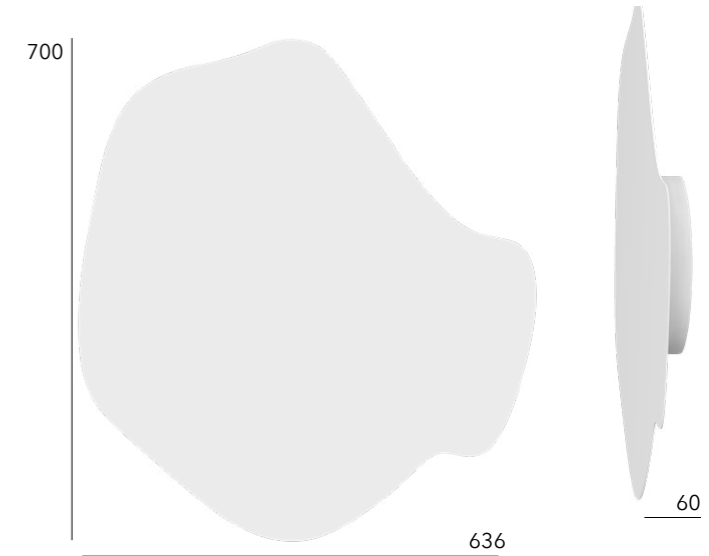
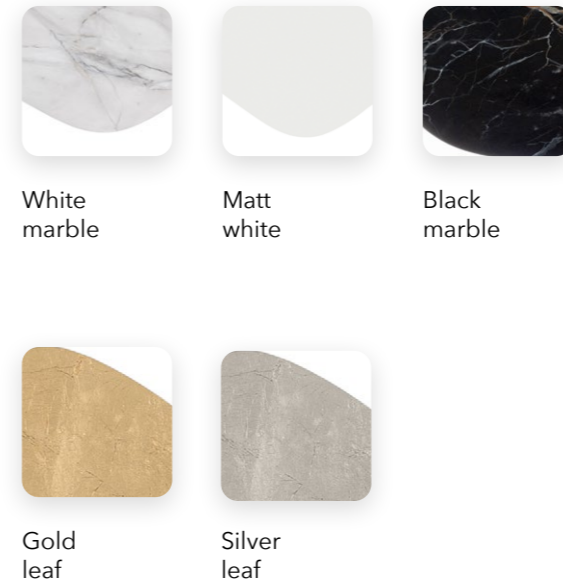

YA-YA 70

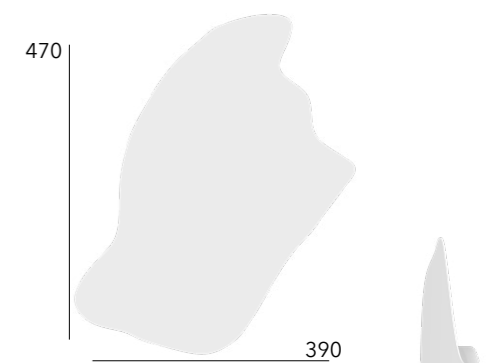

YA-YA 3

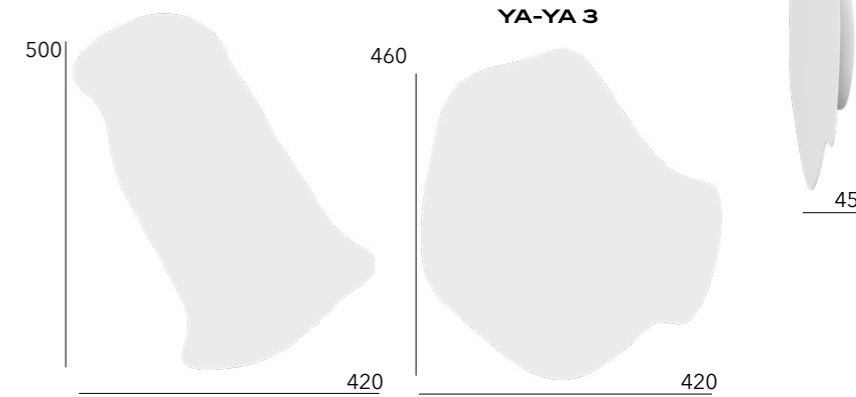

YA-YA 2

YA-YA 1

TECHNICAL

- YA-YA 1 - YA-YA 2 - YA-YA 3
IP20 led module 10w 2700K 1500 lm

- YA-YA 70
IP20 led module 18w 2700K 2500 lm

Phase-cut dimming.

10

ICE ABSOLUT

Design by Hind Rabii / 2015

Anon-Belgian may not yet be able to imagine an ICE, a sweet (praline in «Belgian»). The ICE Absolut enjoys that kind of roundness that captures the senses, brimming with excitement. It is bursting with light, ready to explode in every direction or to be encased in its desires by golden or silver corsets. ICE is as asteroid of light coming from nowhere, coming from elsewhere.





Ice Absolut S Black



Ice Absolut S Mat white



ICE ABSOLUT



ICE ABSOLUT

GLASS FINISH

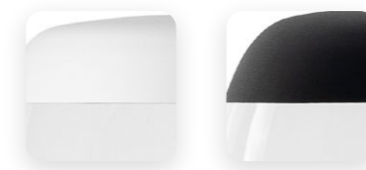

White

Black



Silver leaf

Gold leaf

TECHNICAL

-ICE ABSOLUT S
IP20 led module 10w 2700K 1000 lm

-ICE ABSOLUT L
IP20 led module 17w 2700K 1700 lm

Phase-cut dimming.



ESPRIT YAYA

Design by Hind Rabii / 2017

Forms free from the restrictive tenets of fashion, for now there are three, expressing themselves as mischievous yet aware of their formal presence. YA-YA is mischievous and ironic, its dual personality endearing. YA-YA wears its materials with such timeless elegance that they could be «anything». The rays projected onto its surfaces light up the most colorless mediums and give them graphic presence.





Esprit YAYA Gold



ESPRIT YA-YA



Precision cut metal

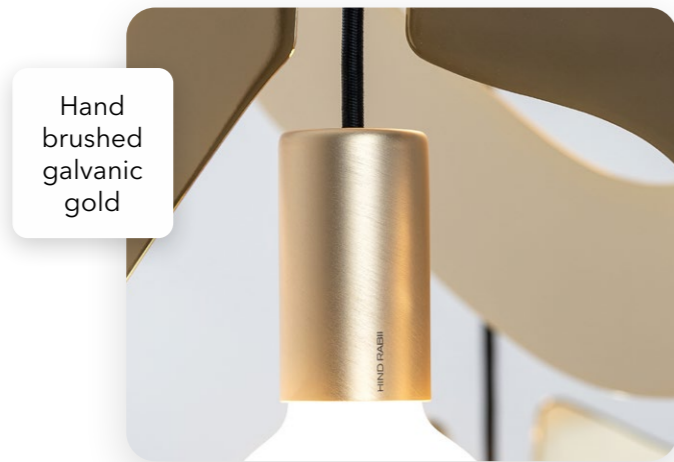

Hand brushed galvanic gold

ESPRIT YA-YA

FINISHES

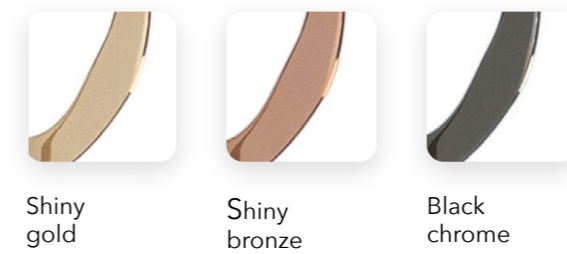

Shiny gold

Shiny bronze

Black chrome



ESP YA-YA 1

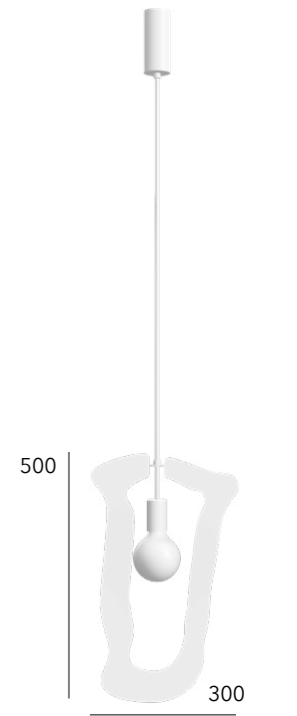

ESP YA-YA 2

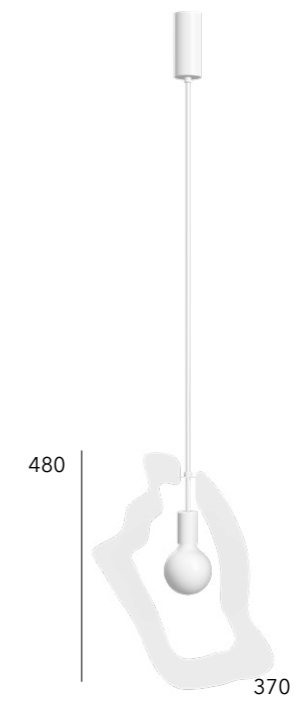

ESP YA-YA 2

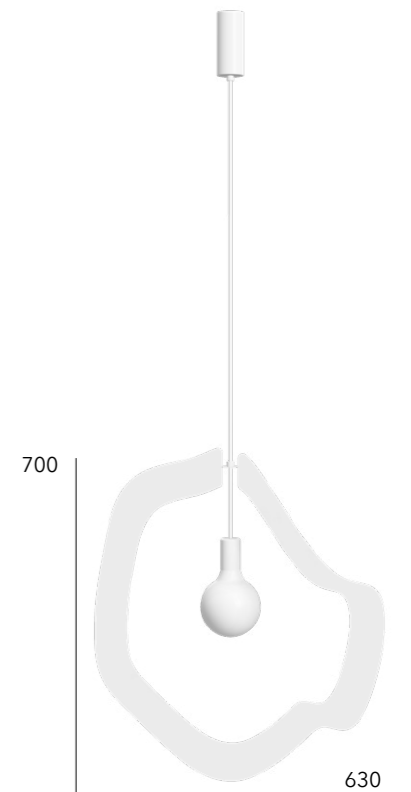

ESP YA-YA 70

TECHNICAL

-ESP YA-YA 1 -ESP YA-YA2 -ESP YA-YA 3
IP20 E27 Led Bulb 6,5w 2500K 450 lm

-ESP YA-YA 70
IP20 E27 Led Bulb 6,5w 2500K 550 lm

Phase-cut dimming.

12

ANNA BELLE

Design by Hind Rabii / 2017

ANNA-BELLE is endowed with an extremely rare elegance. The textiles enjoy a whiteness nuanced by the material used and the crown says a little too much of the purity of its intentions.

For BELLE, seducing you is banal.

The oak, an eternal and timeless material, turned towards MORANDI, is the only «support» that suits it. It'll give your home a presence that's both luminous and strong.





ANNA BELLE

Solid oak



Closed diffusing shade



BASE



Natural

SHADE



White

TECHNICAL

-ANNA BELLE 2
IP20 E27 led bulb 3x10w 2700K 2400 lm

-ANNA BELLE 3
IP20 E27 led bulb 13w 2700K 1500 lm

-ANNA BELLE 5
IP20 E27 led bulb 3x10w 2700K 2400 lm

Cable plug with dimmer switch.

ANNA BELLE

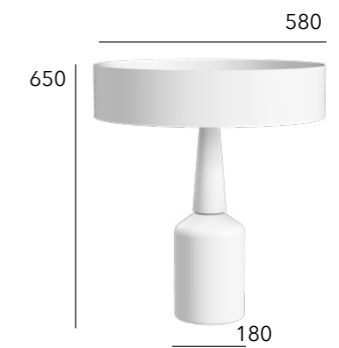

ANNA BELLE 2

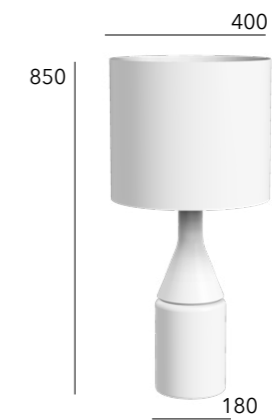

ANNA BELLE 3



ANNA BELLE 5

13

NEWELS

Design by Hind Rabii / 2014

Newel is an essential pendant, free to move, essential as an accessory needed to finish a scenography. Made of metal, available in a range of finishes: Bronze, gold and black chrome, finished by galvanisation. Like a jewel, it shines with its own light thanks to its luminous body with a warm led light. A unique artistic creation that is a precious addition to any environment.





NEWELS

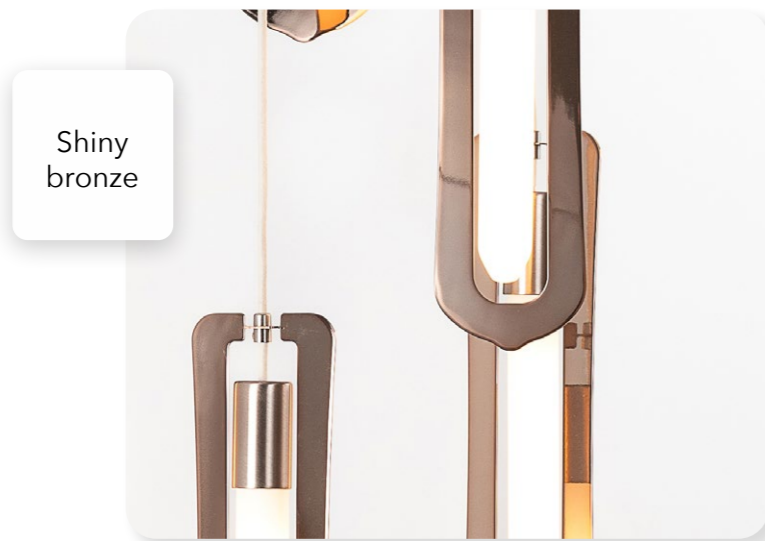
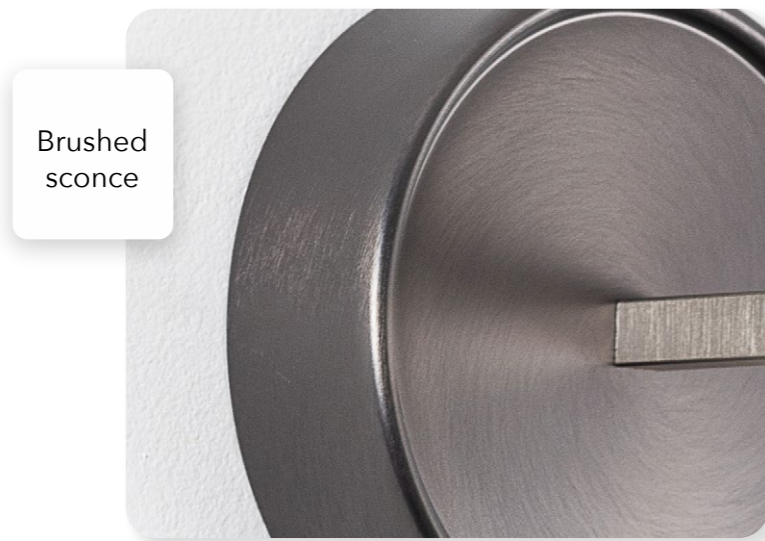

NEWELS

FINISH

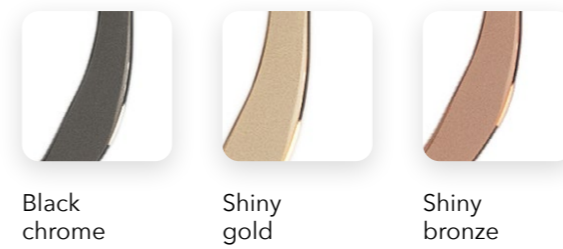

TECHNICAL

- NEWEL WALL
IP20 E27 T30 led bulb 5w 2500K 450 lm
- NEWEL
IP20 E27 T30 led bulb 5w 2500K 450 lm

Phase-cut dimming.

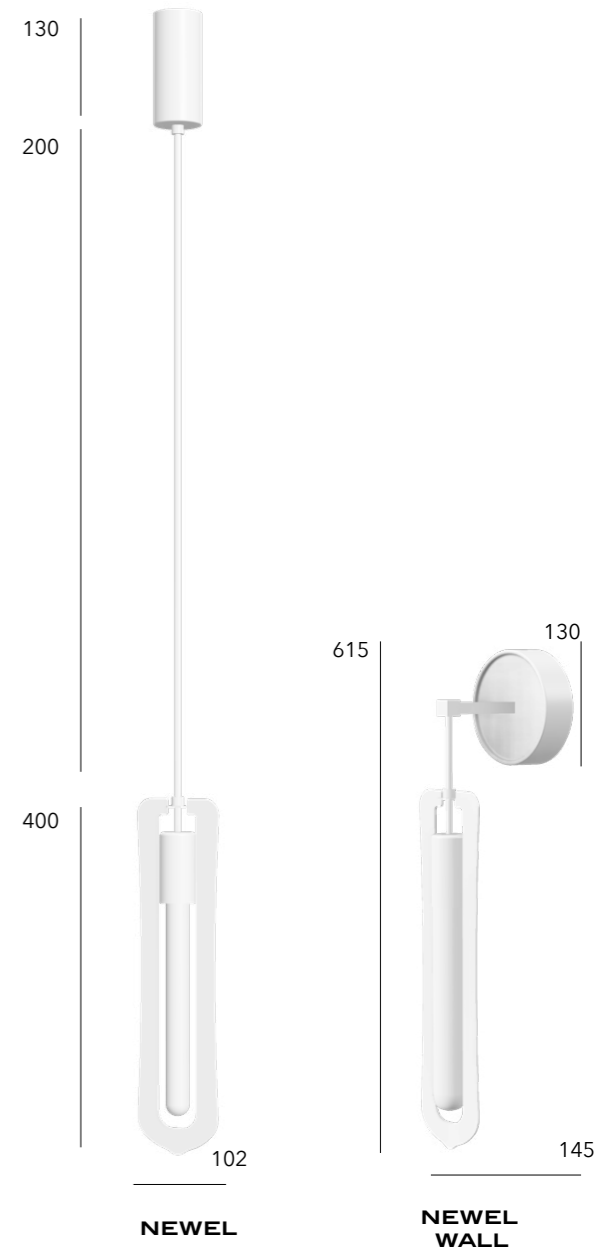

14

3x3x3

Design by Hind Rabii / 2014

Combination of three shapes inspired by nature, mountains and childhood: the bell, the spinning top and the cheese wheel. The metal is brushed for the most beautiful effect.





3x3x3 Wall



3x3x3 Gold

3 X 3 X 3

Detail in up
C1

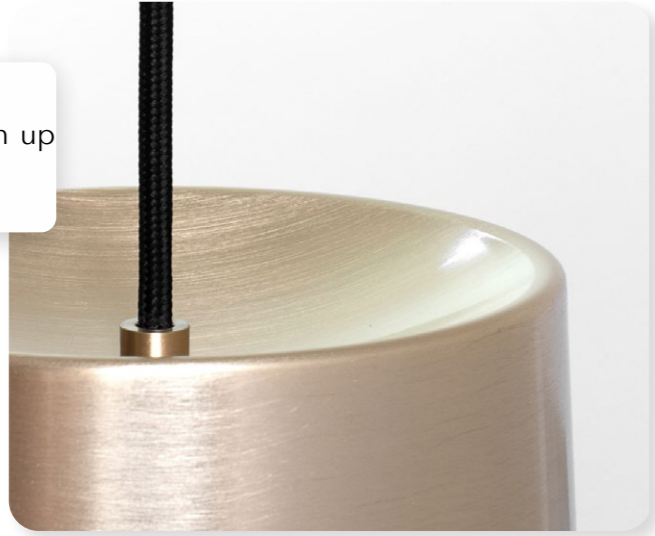

Detail in up
M1



3 X 3 X 3

FINISH



Brushed
gold

TECHNICAL

- C1**
IP20 E27 led bulb 12w 2700K 1055 lm
- M1**
IP20 led module 10w 2700K 1000 lm
- T1**
IP20 E27 led bulb 15w 2700K 1500 lm

Phase-cut dimming.

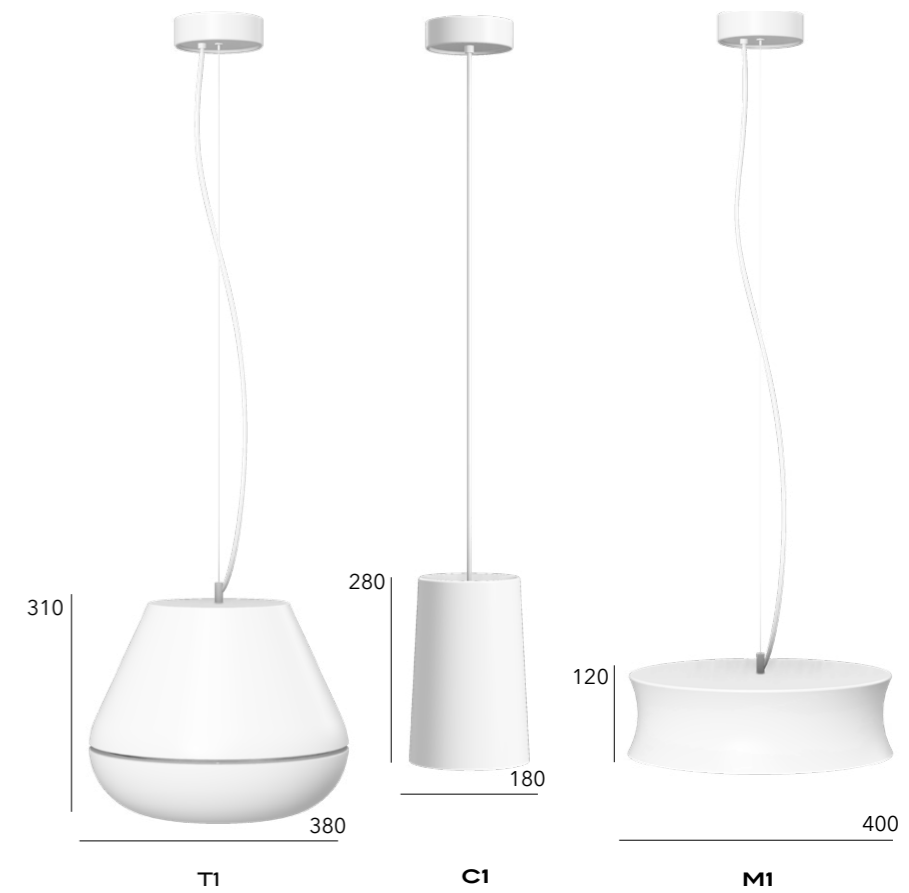

3x3x3 WALL

Design by Hind Rabii / 2017

3x3x3 wall is naturally present to protect light as we protect a treasure.

the light comes up and down, an opal glass hides the source for an optimal diffusion.

3x3x3 wall comes in galvanic finishes, hand brushed, it exists in gold, bronze and a particular fumé blue.



3 X 3 X 3 WALL



3 X 3 X 3 WALL

GLASS FINISH

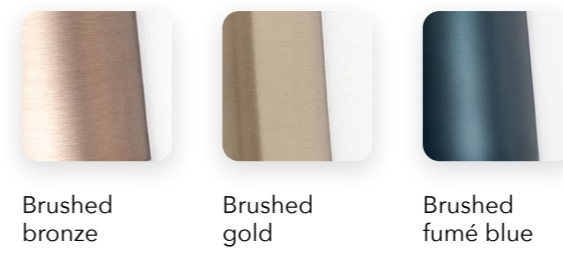

TECHNICAL

-3x3x3 Wall
IP20 G9 Led 2*5W 2700K 900 lm
Phase-cut dimming.



TENUE DE SOIREE

Design by Hind Rabii / 2015

The visual impacts of Tenue de Soirée are impressed in large-scale on the emotion.

They open up the space to romantic, phantasmagorical figures and surround the light with graphic vibrations . Aselection of fabrics , bamboo and other materials, makes Tenue de Soirée changing without any limit.





Tenue de soirée Finesse



Tenue de soirée
Insolence-Mood-Madagascar

TENUE DE SOIREE

Design by Hind Rabii / 2015

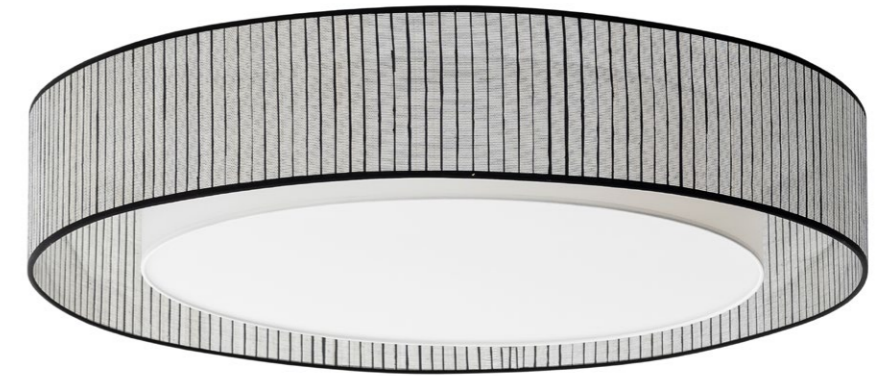
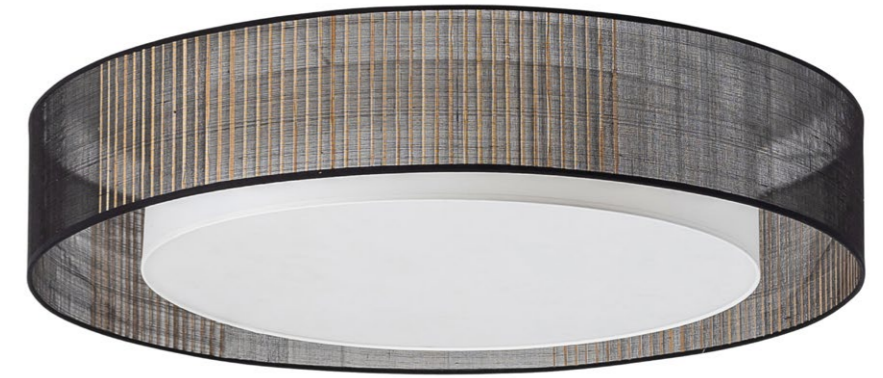

We use the finest fabrics and materials from Belgian, French and Italian Editors.
Most of materials used are handmade with natural bamboo, linen and other delicate materials as hemp.
The only limit for combinations of Tenue de Soirée is Imagination.

TENUE DE SOIRÉE

Linen and bamboo



Diffusor detail



TENUE DE SOIRÉE

SHADE



TECHNICAL

-WLG3000
IP20 E27 led bulb 3x10w 2700K 2400 lm

-WLG3600
IP20 E27 led bulb 3x15w 2700K 4500 lm

Phase-cut dimming.

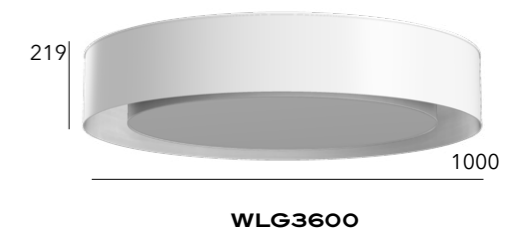
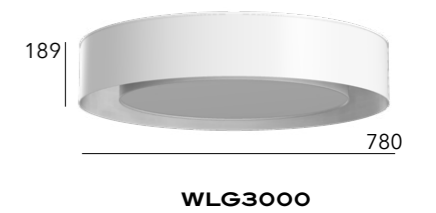

OND'A

Design by Hind Rabii / 2018

Like a flying UFO, Ond'a is of a fluid and airy simplicity while being precious by its materials and the artisanal work of its finishes..



Ond'A Black & Gold



Ond'A Vestita Innocence



OND'A

Gold leaf detail

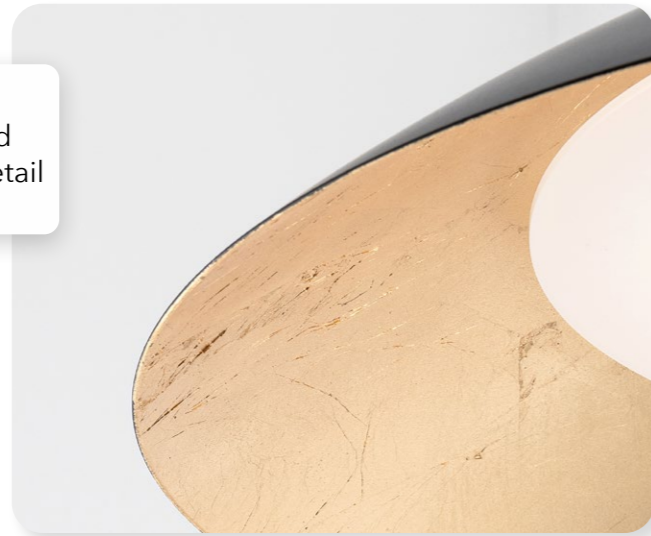

Fineness of materials



OND'A

SHADE

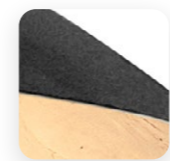

Black on gold

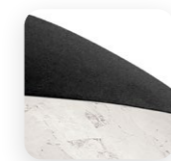

Black on silver

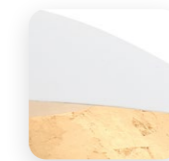

White on gold

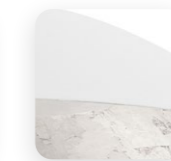

White on silver

OND'A VESTITA

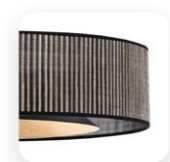

Insolence

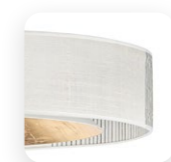

Innocence

TECHNICAL

-OND'A S
IP20 led module 17w 2700K 2200 lm

-OND'A L
IP20 led module 25w 2700K 3000 lm

-OND'A VESTITA
IP20 led module 17w 2700K 2200 lm

Phase-cut dimming.

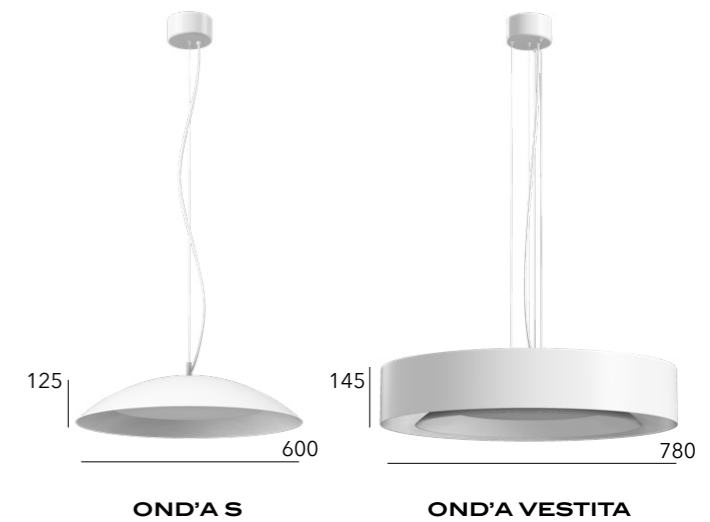

OND'A S

OND'A VESTITA

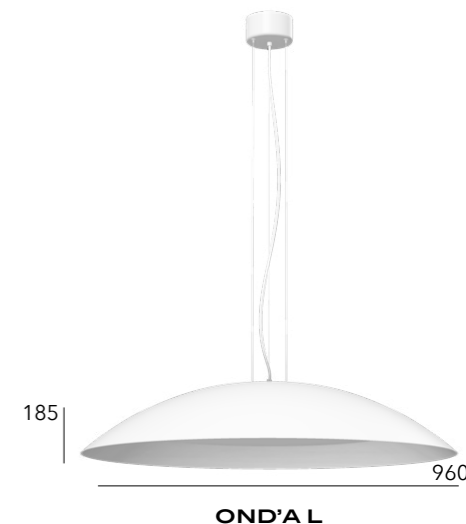

OND'A L

17

ICE DONNA

Design by Hind Rabii / 2017

Ice Donna is elegant as a lady could be,
A long tube with a solid brass base
makes Ice Donna so particular.
The light comes from the reflector that
divides the light for best efficiency.





THE EMPTY VESSEL ANGELLA GRAFF
some are sicker than others
ANDREWS McMEYER

ICE DONNA



STRUCTURE



Black

SHADE

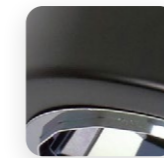

Black with dark grey reflector

TECHNICAL

- ICE DONNA S**
IP20 led module 8w 2700K 800 lm
- ICE DONNA L**
IP20 led module 8w 2700K 800 lm

Cable plug with dimmer switch.

ICE DONNA

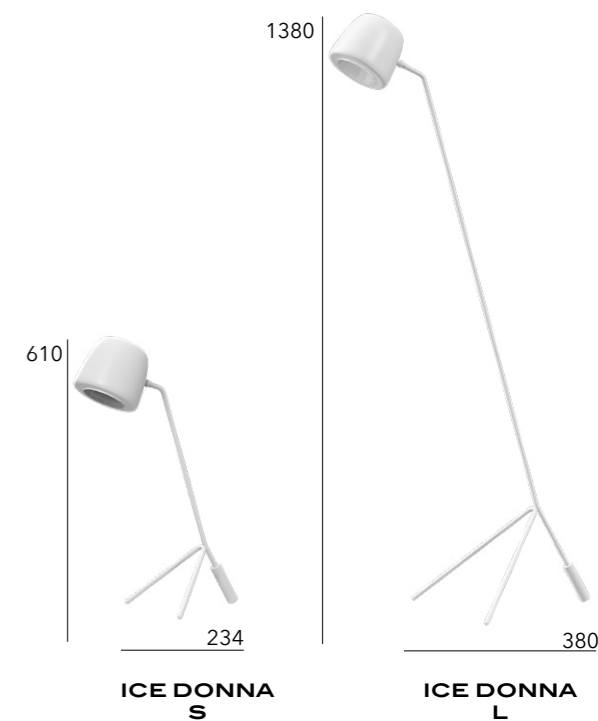



ICE WALL



STRUCTURE



Black

SHADE



Black with dark grey reflector

TECHNICAL

-ICE A30
IP20 led module 8w 2700K 800 lm

-ICE A58
IP20 led module 8w 2700K 800 lm

-ICE A78
IP20 led module 8w 2700K 800 lm

-ICE A120
IP20 led module 8w 2700K 800 lm

Phase cut dimming.

ICE WALL



ICE A30



ICE A58



ICE A78



ICE A120

REFLECTORS

Design by Hind Rabii / 2014

REFLECTOR(S), collection of pendants and wall lamps, with an ample choice of heights and diameters, so that the lamps can be combined to create light effects of varying intensity. Cylindrical shade made from velvet or printed fabric in different variants. Metal reflector in aluminium



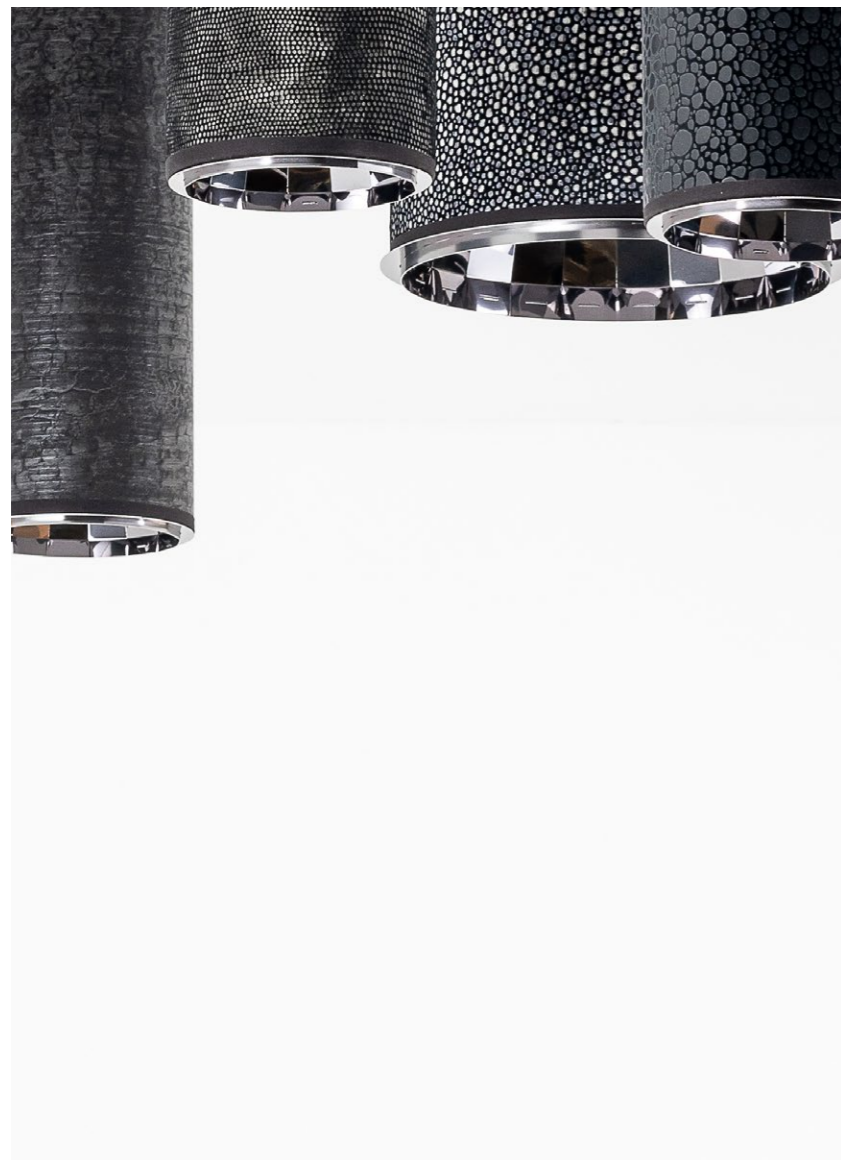

REFLECTOR WALL

Design by Hind Rabii / 2015



The wall version of Reflector plays with light, thanks to a mouth blown glass, half chromed in silver. The light is indirect and is reflected a number of times inside the anodised reflector. the effect is magic.

REFLECTOR(S)

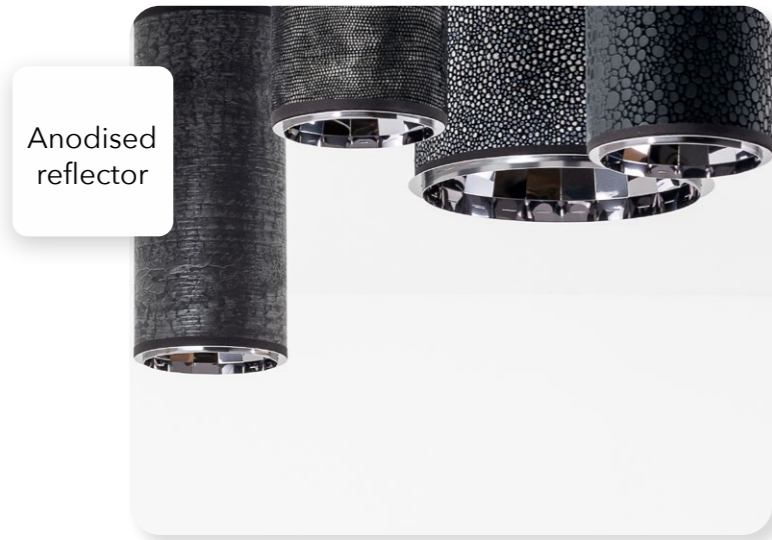

Anodised reflector

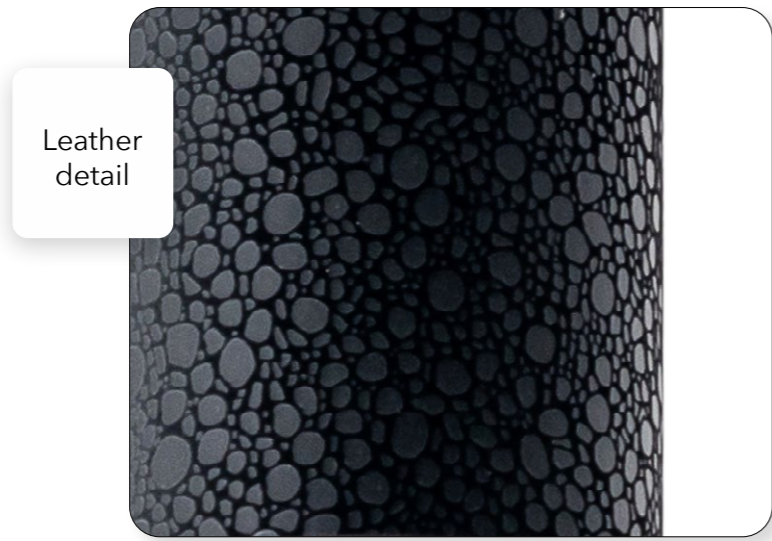

Leather detail

REFLECTOR(S)

SHADE



Ceramic Charbon Corolle Deep night Memoire black Martel silver

BESPOKE

A big choice of finishes is available in our box sample.

REFLECTOR

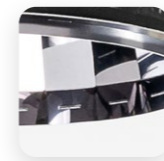

Carbon

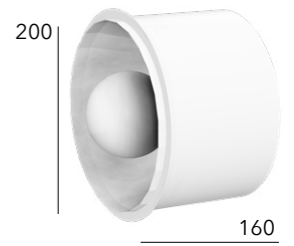

REFLECTOR WALL

TECHNICAL

-RLB 130-RLB140-RLB218-RLB235-RLB250

IP20 led module 8w 2700K 800 lm

-REFLECTOR WALL

IP20 G9 Led bulb 5w 2700 K 500 lm

Phase-cut dimming.

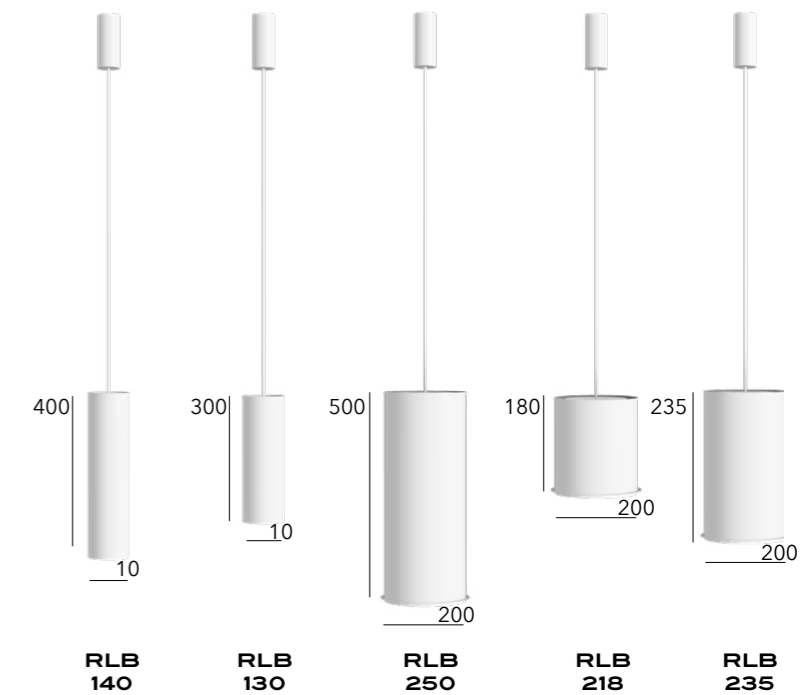

TOP REFLECTORS

Design by Hind Rabii / 2017



TOP-REFLECTOR

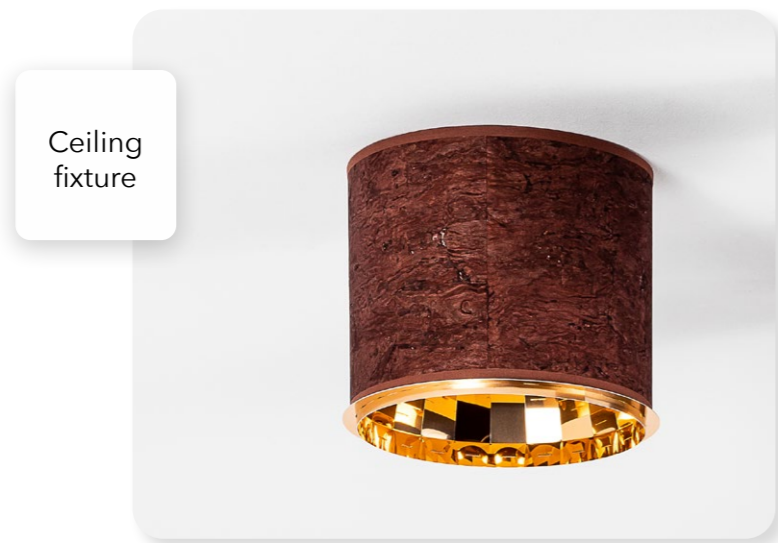
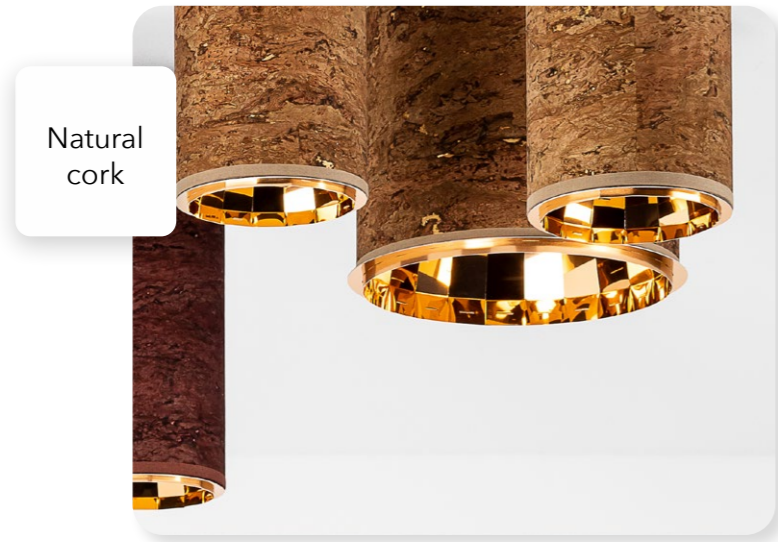

TOP-REFLECTOR

SHADE

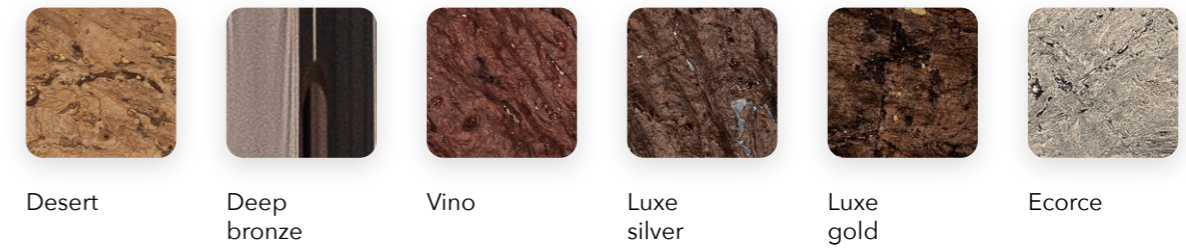

BESPOKE
A big choice of finishes is available in our box sample.

REFLECTOR

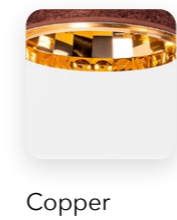

TECHNICAL

- TPR118**
IP20 led module 8w 2700K 800 lm
- TPR125**
IP20 LED MODULE 8W 2700K 800 lm
- TPR216**
IP20 led module 8w 2700K 800 lm

Phase cut dimming.

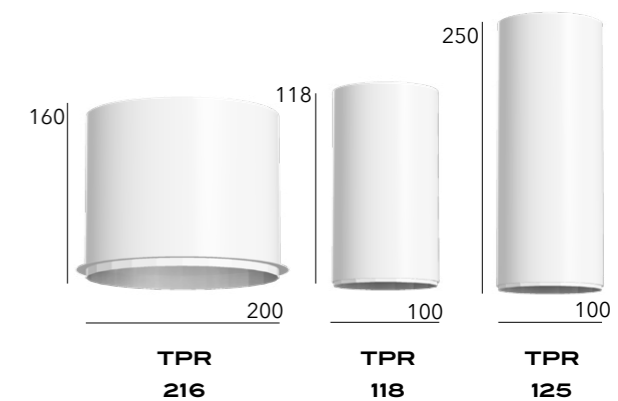

LET ME READ

Design by Hind Rabii / 2022

Let Me Read is a concept. Combination of wall lamp and hanging light, a play of different colors and a mix of two functions. Free of limits, free of space, the suspension may take place anywhere.



LET ME READ

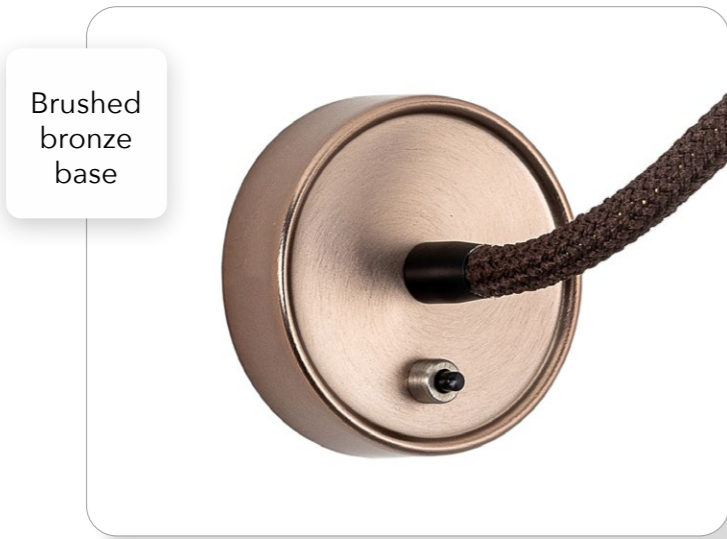
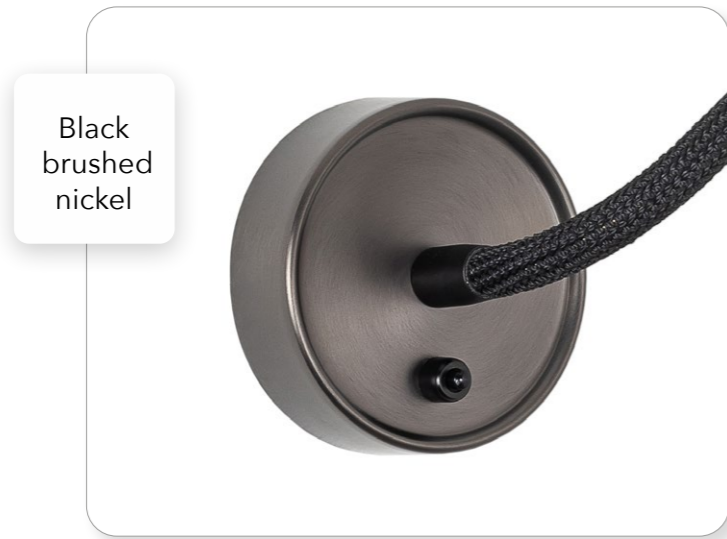

LET ME READ

WALL SCONCE

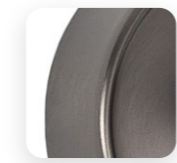

Galvanic black

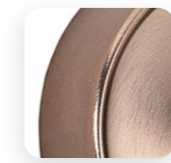

Brushed bronze



Matt white

FLEX



White

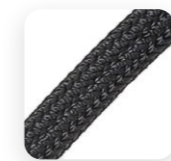

Black

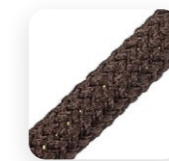

Brown

TECHNICAL

-LMR01-25
IP20 led 3W + lens 2700 K

-LMR01-50
IP20 led 3W + lens 2700 K

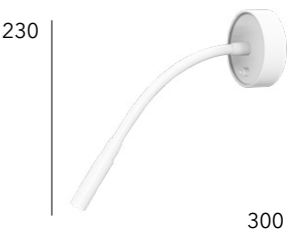

LMR01-25



LMR01-50

NOTES

NOTES

HIND RABII SRL

Warehouse :

Rue Bronde 2 4801 ZI Stembert

Belgium

t. +32 87 22 93 74

e. info@hindrabii.com

w. hindrabii.eu