

DESIGN
LUCE

disegnamo con la luce

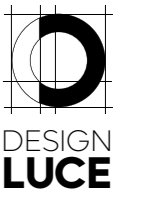

“una storia di passione nella luce a led”

Design Luce nasce a Firenze nell'anno 2000, figlia di una mente creativa e lungimirante, quella di Luigi Cerbone. Napoletano di nascita e toscano di adozione, con un'importante gavetta sulle spalle e un passato da agente nel settore dell'elettrotecnica, Cerbone decide di dedicarsi all'illuminazione. Lo fa con la consapevolezza che è la differenza a fare la differenza: serve un prodotto di eccellenza, funzionale ma elegante, specifico e ricercato. La partenza è la fluorescenza che poi viene implementata con l'avvento del LED, per arrivare all'utilizzo dell'alluminio, la componente indispensabile per la dissipazione del LED. Più flusso, più illuminazione, insomma. Ed è proprio grazie a questo materiale altamente lavorabile che la luce, quella che per Cerbone ha sempre rappresentato vita, benessere e bellezza, incontra il design. Nella sua azienda vengono creati profili italiani studiati da esperti con un occhio sempre puntato su eleganza e raffinatezza.

Design Luce was born in Florence in 2000, the daughter of a creative and far-sighted mind, that of Luigi Cerbone. Neapolitan by birth and Tuscan by adoption, with an important background and a past as an agent in the electrical engineering sector, Cerbone decided to dedicate himself to lighting. He did so with the awareness that it is the difference that makes the difference: you need a product of excellence, functional but elegant, specific and refined. The starting point was fluorescence, which was then implemented with the advent of LEDs, to arrive at the use of aluminium, the essential component for LED dissipation. More flux, more light. And it is thanks to this highly workable material that light, which for Cerbone has always represented life, wellbeing and beauty, meets design. His company creates Italian profiles designed by experts with an eye for elegance and refinement.

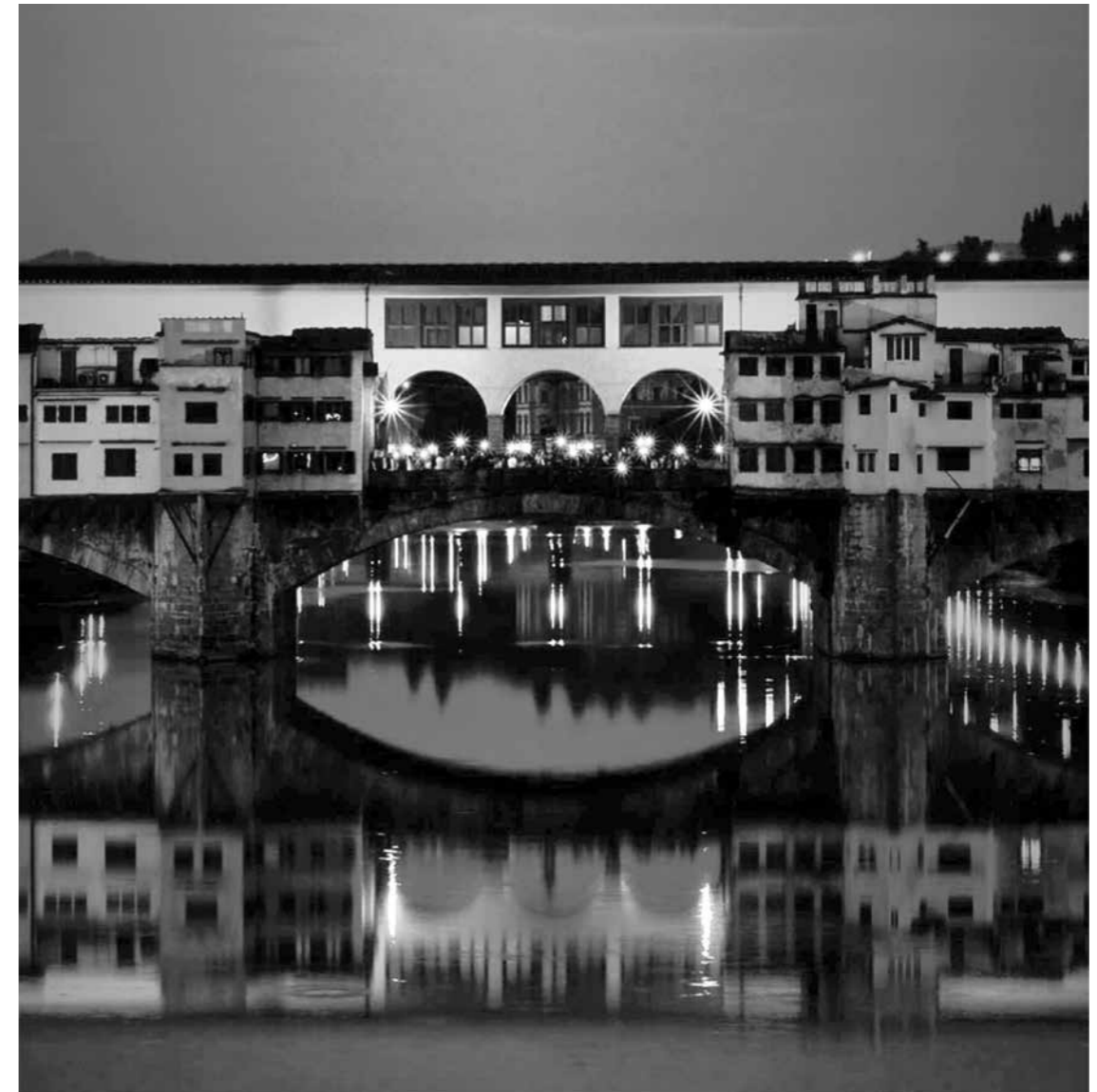



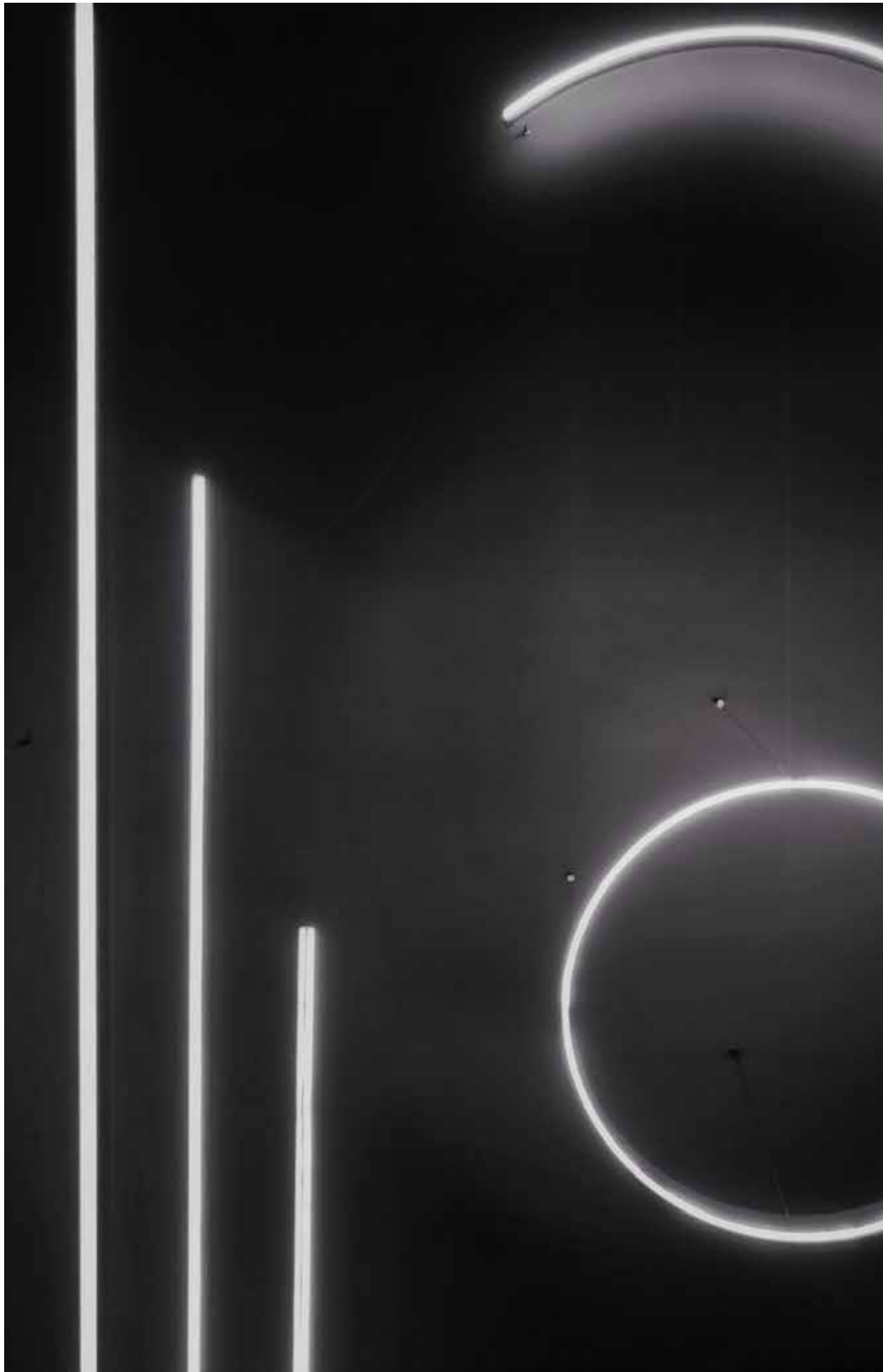

mission

company

design luce



“rispondere a un’esigenza, soddisfare un bisogno”

Da 21 anni Luigi Cerbone è la mente di Design Luce. Le braccia sono quelle di 15 operai, tutti giovanissimi e altamente qualificati, che in quei 1000mq di azienda si sentono a casa. Perché, come è lo stesso Luigi Cerbone a ripetere, l’azienda deve rispecchiare il proprietario. Servono disponibilità e attenzione. Le stesse che Design Luce mette a disposizione del mercato. Un mercato nel quale le regole sono state invertire. Con l’azienda toscana, infatti, gli architetti non si

trovano più costretti a scegliere lampade di dimensioni fisse da adattare al loro progetto ma possono avere un prodotto ad hoc a seconda delle proprie idee. La filosofia, che da subito si configura come mission aziendale, è quella di rispondere a un’esigenza, soddisfare un bisogno, avere risposte pronte. Creare luce attraverso il design sperimentando forme nuove, trasformando un’idea in un progetto di luce. Esaltare la bellezza, illuminarla al meglio.



Luigi Cerbone has been the mind of Design Luce for 21 years. The arms are those of 15 workers, all very young and highly qualified, who feel at home in those 1000sqm of company. Because, as Luigi Cerbone himself repeats, the company must reflect the owner. Availability and attention are needed. The same ones that Design Luce makes available to the market. A market in which the rules have been reversed. With the Tuscan company, in fact, architects are no longer forced to choose lamps of fixed dimensions to adapt to their project but can have an ad hoc product according to their ideas. The philosophy, which immediately takes the form of a corporate mission, is to respond to a need, satisfy a need, have ready answers. Creating light through design by experimenting with new forms, transforming an idea into a light project. Enhance beauty, illuminate it to the fullest.



“dissipazione, innovazione e alti livelli di qualità”

ALLUMINIO E DISSIPAZIONE

Design Luce è la prima azienda italiana ad aver profondamente capito l'importanza delle dissipazioni del calore delle sorgenti luminose flessibili a LED.

Tutti i profili prodotti sono in alluminio estruso e sono stati progettati allo scopo di garantire la dissipazione ottimale del calore generato dalla sorgente luminosa.

Spessore di alluminio 100% italiano > 1,5 mm = Dissipazione ottimale del calore = Elevata durata della sorgente luminosa

LED CRI>95 E LED CRI>97

La tecnologia LED ha portato una notevole innovazione nel panorama illuminotecnico: ai tradizionali parametri utilizzati per la classificazione delle lampade alogene e a scarica si sono aggiunti nuovi criteri di valutazione fotometrica. I LED flessibili di Design Luce presentano alti livelli qualitativi e garantiscono la massima resa cromatica nonché un notevole comfort visivo.

ALUMINUM AND DISSIPATION

Design Luce is the first Italian company to have deeply understood the importance of heat dissipation from flexible LED light sources.

All the profiles produced are in extruded aluminum and have been designed in order to ensure optimal dissipation of the heat generated by the light source.

100% Italian aluminum thickness > 1.5 mm = Optimal heat dissipation = Long duration of the light source

LED CRI> 95 AND LED CRI> 97

LED technology has brought considerable innovation to the lighting panorama: new photometric evaluation criteria have been added to the traditional parameters used for the classification of halogen and discharge lamps. The flexible LEDs of Design Luce have high quality levels and guarantee maximum color rendering as well as considerable visual comfort.

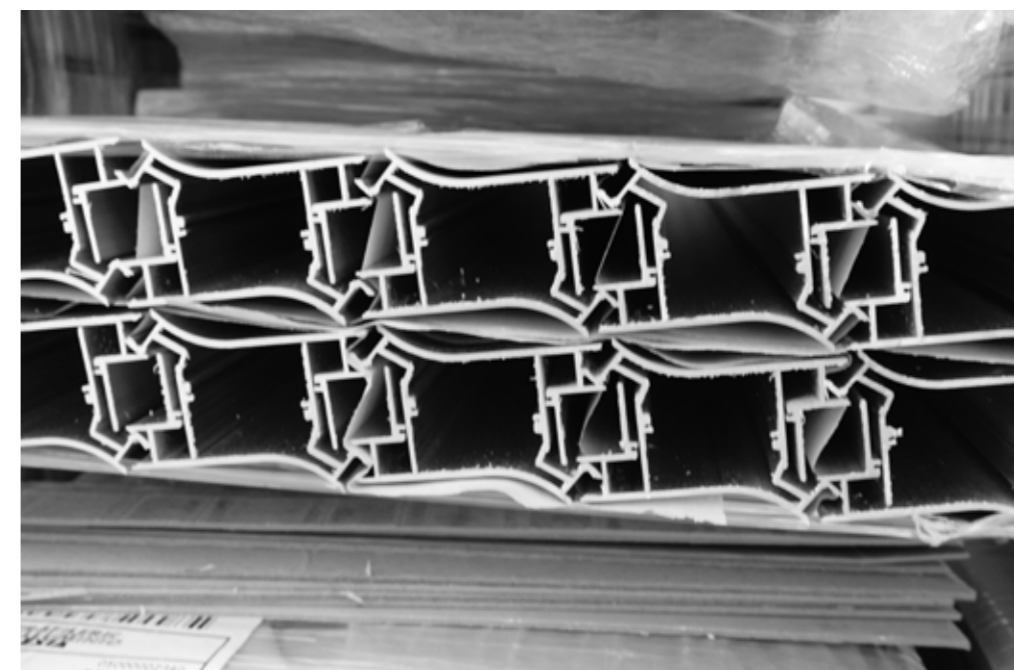
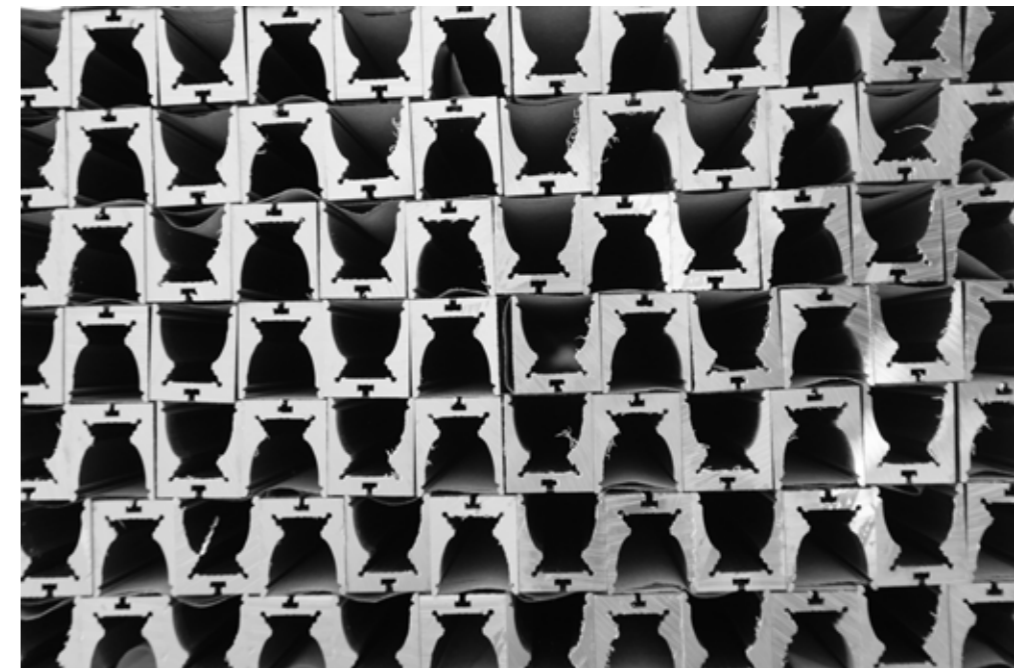

“ricerca, investimenti mirati e costanti, manodopera specializzata”

Alla base di un prodotto di qualità ci sono ricerca, investimenti mirati e costanti, manodopera specializzata. Tutti i nostri prodotti sono collaudati e testati 100% con uno strumento di verifica che gli conferisce la conformità alle norme CEI e la marcatura CE. Ma l'alta qualità è data anche dalla passione per il proprio lavoro e dalla volontà di soddisfare a pieno le esigenze dei clienti che quotidianamente si rivolgono alla Design Luce per illuminare ogni loro istante.

At the base of a quality product there are research, targeted and constant investments, skilled labor. All our products are tested and tested 100% with a verification tool that gives them compliance with CEI standards and CE marking. But the high quality is also given by the passion for their work and the desire to fully satisfy the needs of customers who daily turn to Design Luce to illuminate their every moment.



qualità

mission

quality

design luce



“dall'estetica di un impercettibile segmento luminoso allo stupore di una luce diffusa e a spot”

Dall'estetica di un impercettibile segmento luminoso allo stupore di una luce diffusa e a spot nello spazio, mantenendo inalterato l'alto livello di efficienza luminosa.

LED flessibili di alta qualità progettati dal nostro ufficio tecnico e realizzati appositamente per la Design Luce al fine di garantire un prodotto unico e a “misura” di progetto.

From the aesthetics of an imperceptible light segment to the amazement of a diffused light in the space while maintaining the high level of luminous efficiency.

High quality flexible LEDs designed by our technical department and made specifically for Design Luce in order to guarantee a unique product tailored to the project.





mission

efficiency

design luce



“un prodotto su misura che si adatta perfettamente al cliente”

La Design Luce nasce con un obiettivo preciso: realizzare un prodotto su misura che si adatti perfettamente al cliente, esattamente come un abito di alta sartoria. Grazie alla possibilità del “taglio a misura al cm” lineare e angolare, ad un’ampia gamma di finiture e a specifici accessori per ogni tipologia di installazione, si ottiene un’elevata versatilità nella realizzazione dei progetti. Versatilità unita ad un’eleganza inconfondibile che parla la lingua del Made in Italy. Profili in alluminio estruso, diffusori in policarbonato opali, satinati e prismatici, accessori e minuteria: ogni singolo prodotto di Design Luce è progettato e interamente realizzato in Italia grazie alla collaborazione con le migliori aziende certificate del settore.

Design Luce was born with a specific goal: to create a tailor-made product that fits perfectly to the customer, just like a haute couture suit. Thanks to the possibility of the linear and angular “cut to size per cm”, a wide range of finishes and specific accessories for each type of installation, a high versatility is obtained in the realization of projects. Versatility combined with an unmistakable elegance that speaks the language of Made in Italy. Extruded aluminum profiles, opal, satin and prismatic polycarbonate diffusers, accessories and small parts: every single Design Luce product is designed and entirely made in Italy thanks to the collaboration with the best certified companies in the sector.

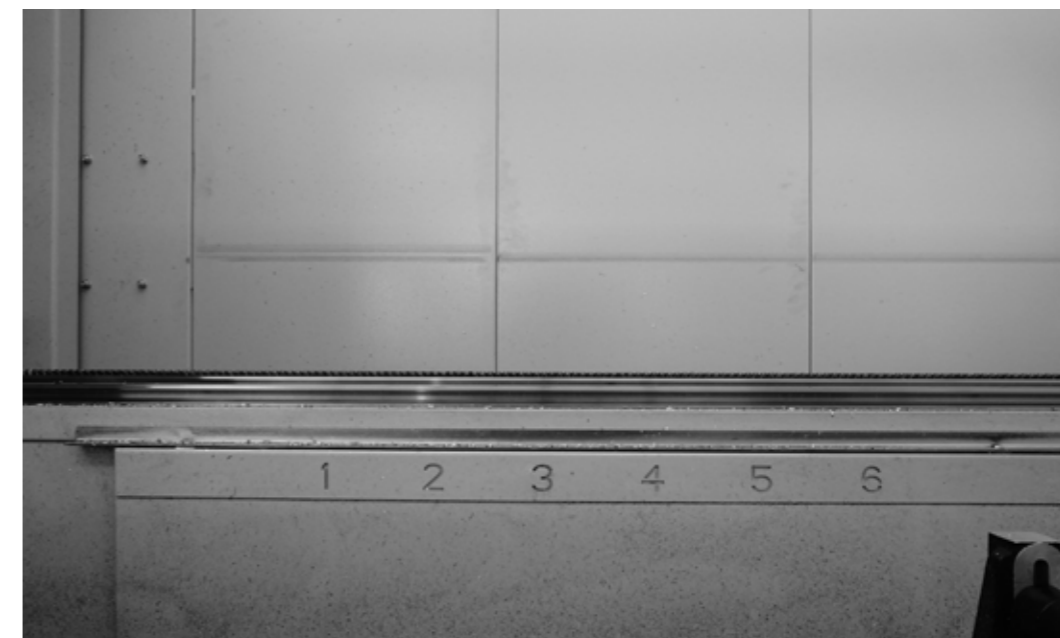
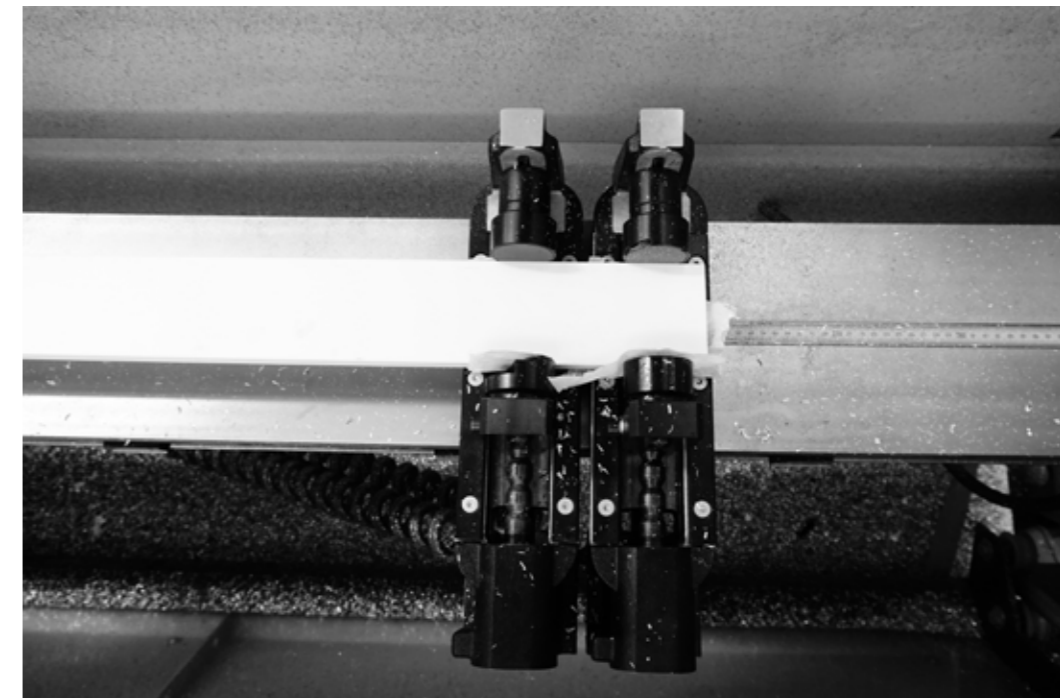



“le finiture dei profili uniscono funzionalità ed eleganza”

Le finiture dei profili uniscono funzionalità ed eleganza. Il nero non è il solo colore utilizzato: in alternativa troviamo numerose tonalità, alcune classiche e sofisticate come il bianco e i grigi, altre decisamente più particolari come l'oro. La scelta è ampia e sottolinea la costante volontà di offrire prodotti di design perfettamente adattabili ad ogni ambiente.

The finishes of the profiles combine functionality and elegance. Black is not the only color used: alternatively we find numerous shades, some classic and sophisticated such as white and grays, others decidedly more particular such as gold. The choice is wide and underlines the constant desire to offer design products that are perfectly adaptable to any environment.

finishes

customization

design luce



00. grigio vesuvio



01. argilla



02. argento



03. bianco



04. nero



05. moka



08. cromo



09. oro



10. aramen



11. grigio avio



12. argento cometa



13. ottone veneziano



14. titanio



15. bronzo di riaci



16. verde costa



17. terra senese



34. bianco nero



38. bianco cromo



41. nero aramen



43. nero bianco



48. nero cromo



49. nero oro



84. cromo nero

“una realtà dinamica in forte espansione”

Design Luce è una realtà dinamica in continua espansione, non solo a livello italiano, nel quale si è ritagliata un ruolo di prestigio. L'obiettivo è la crescita nel mercato europeo. Due sono state le partecipazioni importanti: la prima al nostrano Salone del mobile di Milano, la seconda al Salone di Francoforte.

In entrambi gli eventi Design Luce ha dimostrato di essere un forte competitor in un settore in continuo sviluppo.

Design Luce is a dynamic reality in continuous expansion, not only on an Italian level, in which it has carved out a prestigious role. The goal is growth in the European market. There were two important participations: the first at our Milan Furniture Fair, the second at the Frankfurt Motor Show.

In both events, Design Luce proved to be a strong competitor in a continuously developing sector.

 **Salone del Mobile. Milano**

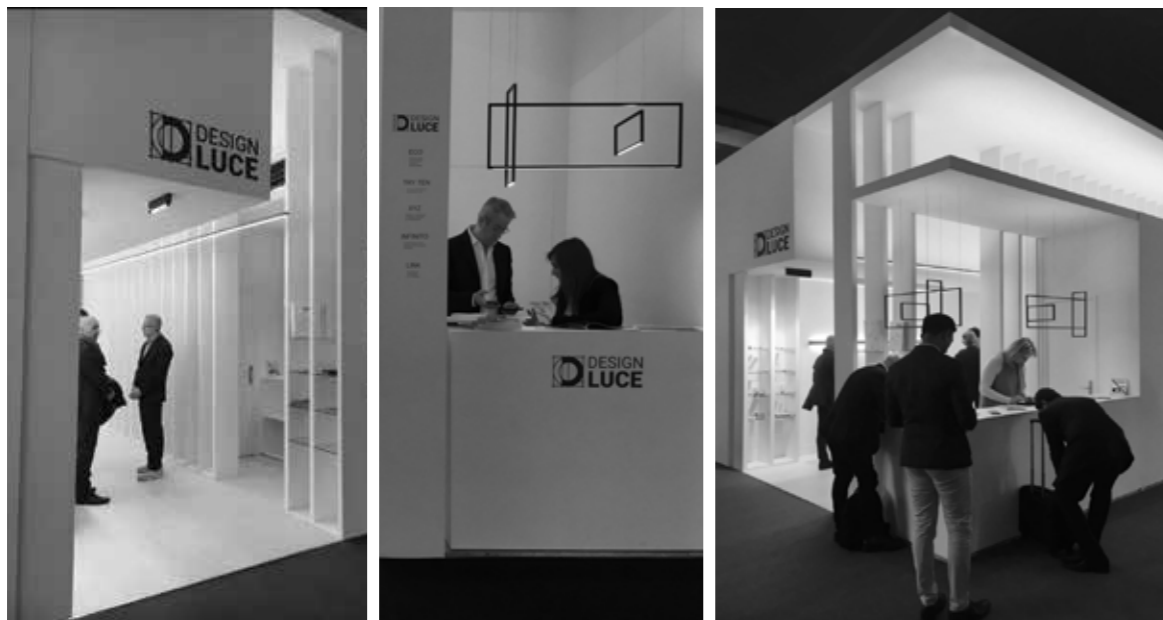

light+building
stand

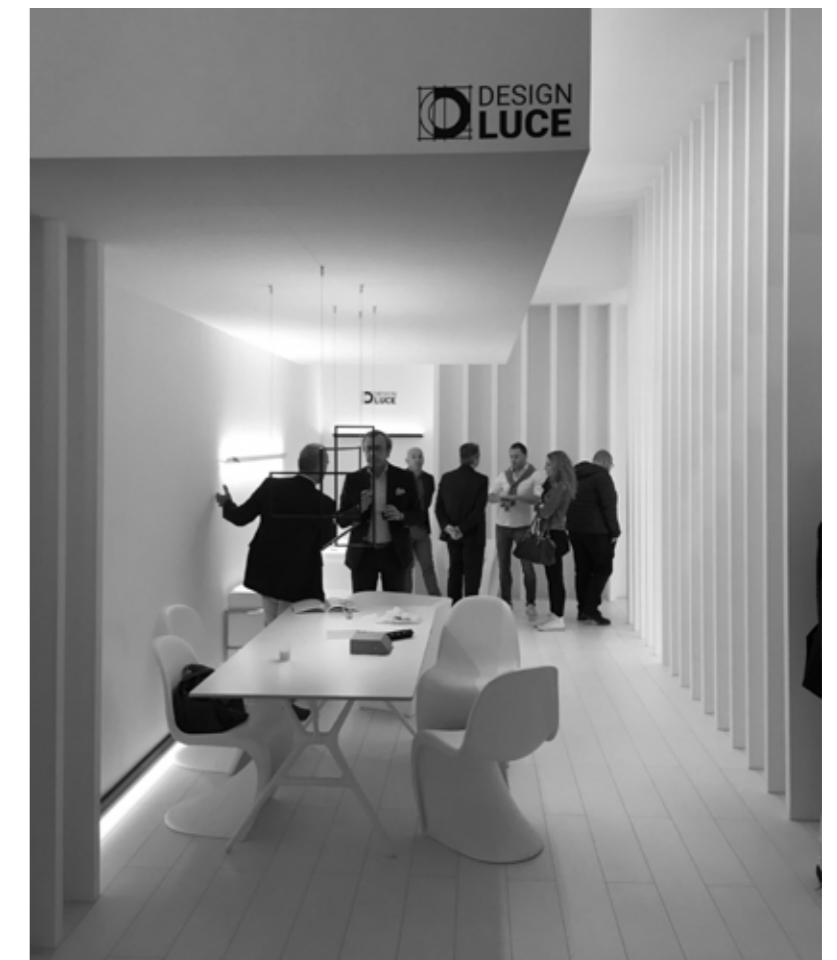



Small rectangular object, possibly a piece of paper or a small sign, attached to the left side of the window frame.

DESIGN
LUC

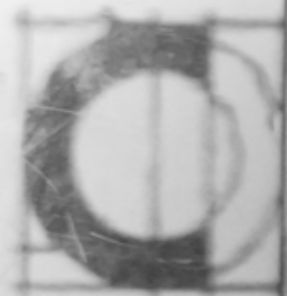

designers

designers

designluce

2021—2022

arch. marco ciarlo

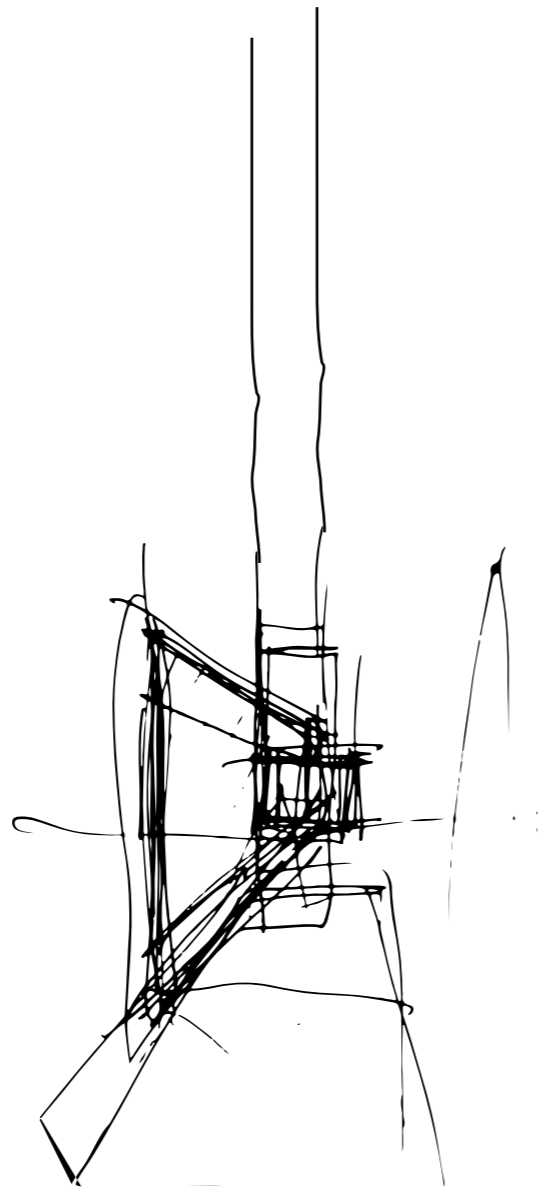

designer

marco ciarlo

design luce



Marco Ciarlo inizia l'attività nel 1988 sotto la direzione dell'Architetto Teobaldo Rossigno affiancando alla professione attività in campo artistico di ricerca sull'immagine e la materia. Dal 1993 avvia la collaborazione con gli architetti Fabrizio Melano e Giampiero Negro, con i quali si associa nel 2004. Lo Studio sviluppa progetti di architettura pubblici e privati e si occupa di interni, allestimenti e design. Le opere realizzate rispondono alla volontà di far dialogare figure e materiali rigorosamente contemporanei con i luoghi che li accolgono: in questo confronto, risiede il valore dell'esperienza progettuale sviluppata dallo studio. Spesso diventano determinanti l'accostamento di materiali nobili e poveri, le lavorazioni artigianali e industriali o le variazioni di tessiture e cromatismi delle superfici che a volte tendono alla rarefazione.

Marco Ciarlo started his career in 1988 under the direction of Architect Teobaldo Rossigno, joining his profession with artistic research on image and material. In 1993 he started collaborating with architects Fabrizio Melano and Giampiero Negro, they joined in 2004. The Studio develops public and private architecture projects and deals with interiors, installations and design. The works created respond to the desire to make figures and materials dialogue rigorously contemporary with the places that welcome them: the value of the design experience developed by the studio lies in this comparison. The combination of noble and poor materials, handcrafted and industrial processes or variations in the texture and colour of surfaces, that sometimes tend to be rarefied, often become decisive.

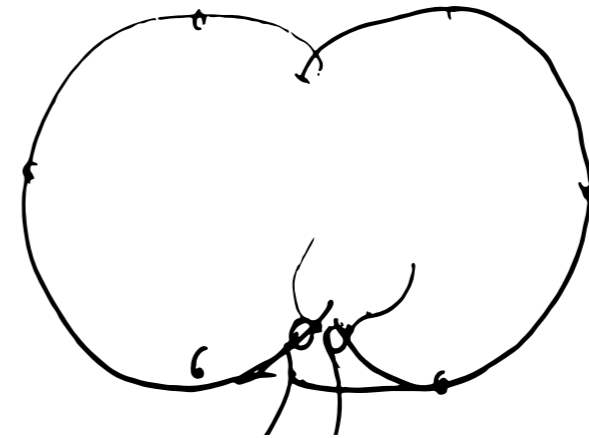

diego chilò designer

designer

diego chilò

design luce

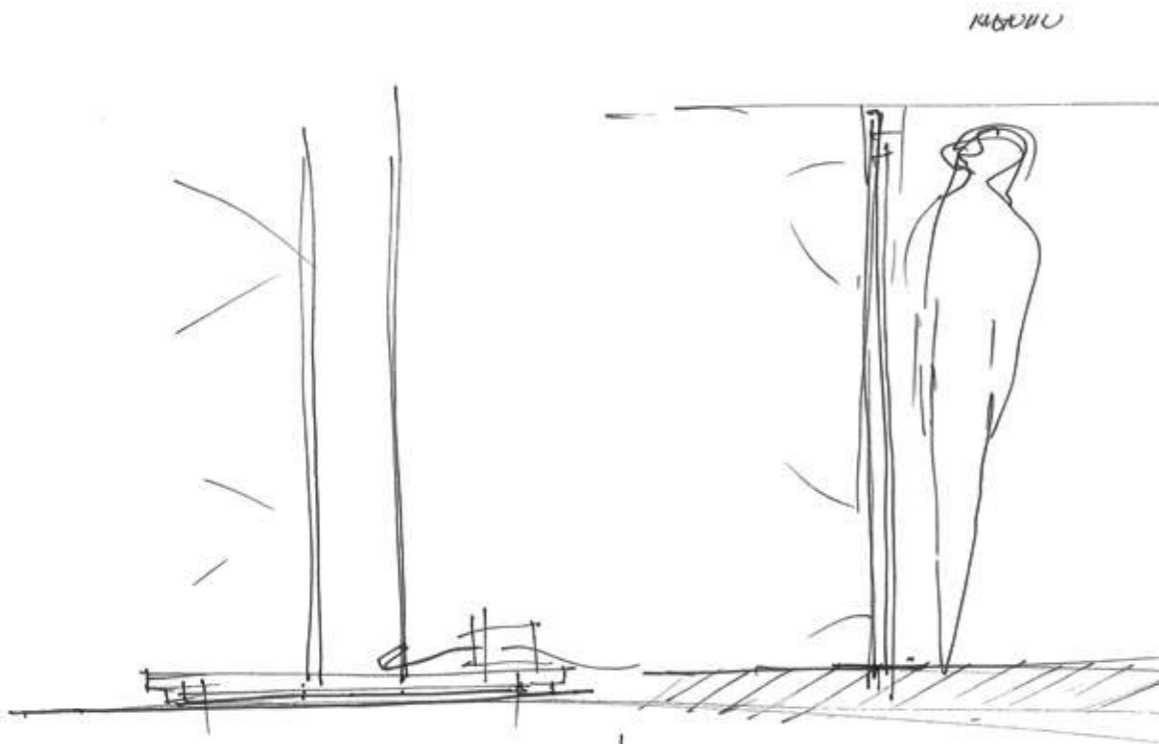

Ho avuto modo, in diverse occasioni, di conoscere, installare e confrontarmi con i prodotti di Design Luce e con la proprietà. Durante i nostri numerosi incontri, avvenuti presso il mio studio e nella loro azienda, abbiamo dialogato a lungo, non solo sui prodotti ma anche sullo spirito e sull'indirizzo aziendale. Dopo qualche anno di reciproca conoscenza e stima, abbiamo intrapreso un percorso di collaborazione con l'obiettivo di creare, non solo dei nuovi prodotti, ma anche ideare, dei nuovi oggetti di luce utilizzando gli elementi già disponibili in catalogo; questa esigenza nasceva, molto spesso, dalle necessità dei singoli progetti di luce creati con le numerose applicazioni dei profili di Design Luce che integro nei vari lavori del mio studio. È nata così una stretta sinergia, nel reciproco rispetto, dove idea, prodotto e risultato sono condivisi: Strallo e Astón ne sono un esempio. Nel campo della luce ha collaborato e collabora con numerose aziende tra le quali Andromeda, Arcom, Carlo Moretti, CLM, Design Luce, Disegnoluce, Leucos, Light4, Mareco, Marino Cristal, Vistosi-Ono Luce, Panzeri, Prandina, Sirrah, Venini.

I have had the opportunity, on several occasions, to get to know, install and deal with the Design Luce products and the owners. During our numerous meetings, which took place in my studio and in their company, we had a long dialogue, not only about the products but also about the spirit and the direction of the company. After a few years of mutual acquaintance and esteem, we embarked on a path of collaboration with the aim of creating, not only new products, but also of conceiving, new objects of light using the elements already available in the catalogue; this need arose, very often, from the needs of individual lighting projects created with the numerous applications of the Design Luce profiles that I integrate in the various works of my studio. Thus a close synergy was born, in mutual respect, where idea, product and result are shared: Strallo and Astón are examples of this. In the field of light he has collaborated and collaborates with numerous companies including Andromeda, Arcom, Carlo Moretti, CLM, Design Luce, Disegnoluce, Leucos, Light4, Mareco, Marino Cristal, Vistosi-Ono Luce, Panzeri, Prandina, Sirrah, Venini.

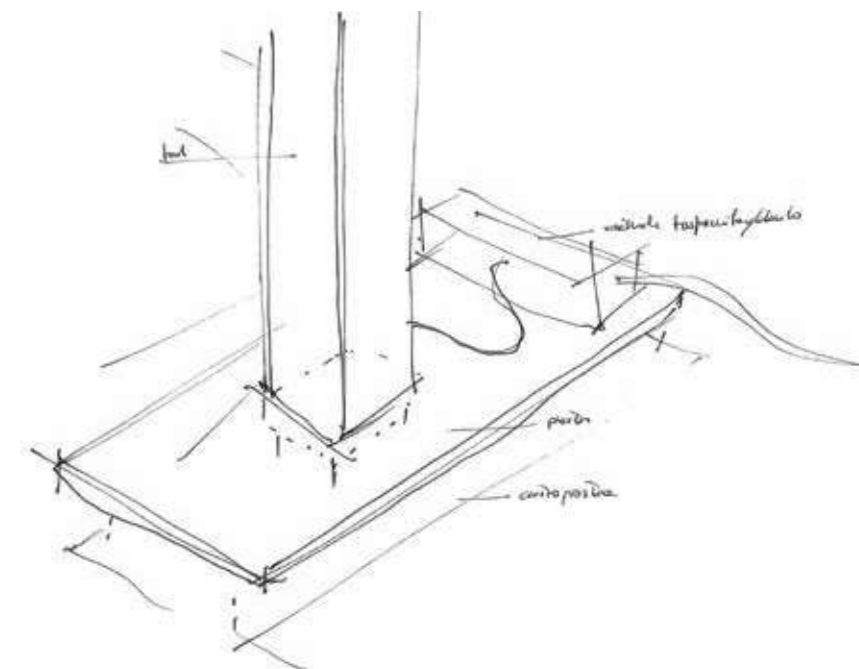

Lo Studio HABITS è stato fondato nel 2004 da Innocenzo Rifino e Diego Rossi, dopo alcuni anni di esperienze professionali indipendenti tra l'Italia e il Giappone, sviluppando progetti di robotica, illuminazione e interaction design.

Oggi, lo Studio HABITS ha ampliato la propria esperienza professionale in differenti aree industriali, ha sviluppato cooperazioni in varie parti del mondo e segue progetti di rilevanza globale. Collezionando oltre 100 premi internazionali di design, come Red Dot, IF, Good Design, Design Plus, German Design Award, ADI Compasso d'Oro. I lavori si concentrano in gran parte su prodotti digitali, IoT e oggetti smart, domotica, elettrodomestici, illuminazione.

Lo Studio ha implementato un metodo di progettazione basato sul rapido passaggio dalle idee ai prototipi, secondo un ciclo continuo e concreto che porta ad una consistente rappresentazione e definizione dell'idea progettuale.

Il movimento, come elemento di progetto, può essere considerato la caratteristica peculiare della ricerca condotta dallo Studio HABITS in collaborazione con DesignLuce. I profili luminosi, come elementi di una geometria primitiva, vengono di volta in volta animati nello spazio per assecondare le esigenze del progetto. Il disegno, definendo unicamente i limiti di tali movimenti, crea un'immagine dinamica e mutevole; la sfida è quella di riuscire a nascondere ogni tecnicismo ottenendo un'estetica il più possibile astratta e minimale.

Studio HABITS was founded in 2004 by Innocenzo Rifino and Diego Rossi, after several years of independent professional experience between Italy and Japan, developing projects in robotics, lighting and interaction design.

Today, Studio HABITS has expanded its professional experience in different industrial areas, has developed cooperation in various parts of the world and follows projects of global relevance collecting more than 100 international design awards, such as Red Dot, IF, Good Design, Design Plus, German Design Award, ADI Compasso d'Oro.

The work focuses largely on digital products, IoT and smart objects, home automation, household appliances, lighting.

The studio has implemented a design method based on the rapid passage from ideas to prototypes, according to a continuous and concrete cycle that leads to a consistent representation and definition of the design idea. Movement, as a design element, can be considered the distinctive feature of the research carried out by Studio HABITS in collaboration with DesignLuce. The light profiles, like elements of a primitive geometry, are animated in space from time to time to meet the needs of the project. The design, by defining only the limits of these movements, creates a dynamic and changing image; the challenge is to succeed in hiding all technicalities, obtaining an aesthetic as abstract and minimal as possible.

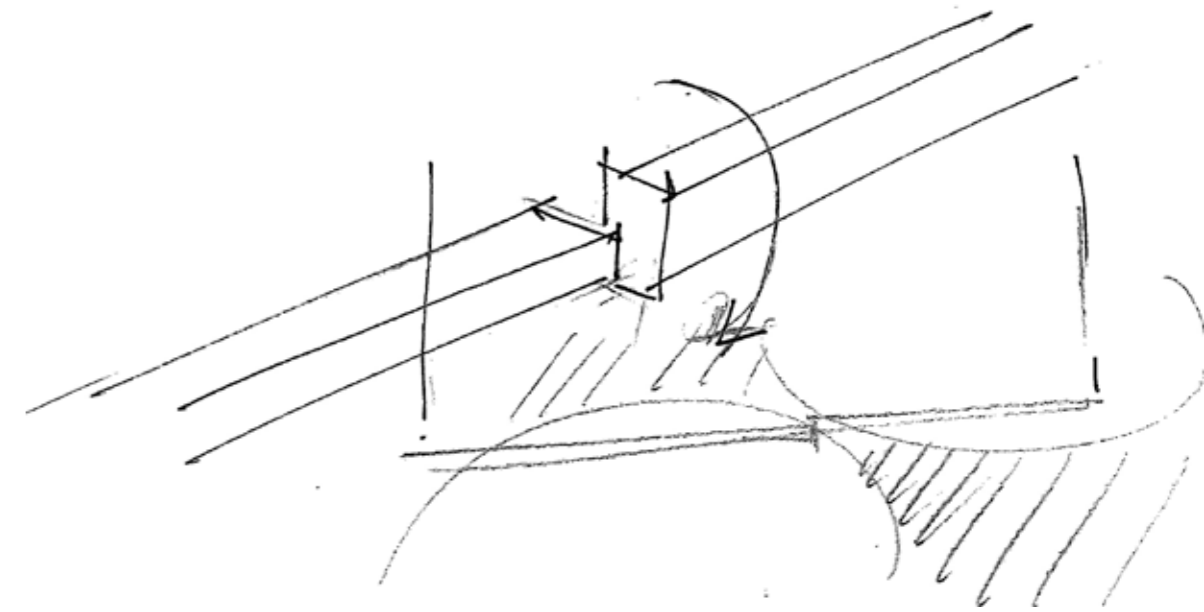
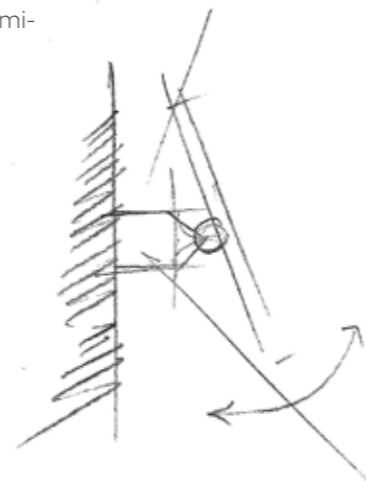

Domenico Pagnano, Giuseppe Giusto, Antonella Maggini e fondano lo studio MIMESI 62 Architetti Associati nel 1996.

Hanno fatto, fanno e cercano di fare architettura in Italia progettando edifici, spazi pubblici, interni e complementi d'arredo, puntando alla flessibilità e regolando l'offerta sulle esigenze dei clienti.

Vincono diversi concorsi, realizzando il Centro per la musica e l'arte di Misterbianco (CT), la riqualificazione di P.zza V. Veneto a Montevarchi (AR), il recupero dell'ex Villaggio Minatori a S. Giovanni Valdarno (FI), la P.zza di Varlungo a Firenze.

Vincono il primo premio nel concorso internazionale per la ristrutturazione dell'area PR8 a Viareggio e per la P.zza del Santuario della Madonna delle Grazie a Curtatone, il secondo premio nei concorsi per la riqualificazione urbana dell'area compresa fra P.zza Martiri della Libertà e P.zza Garibaldi a Casciana Terme (Pisa), di P.zza Guala e di P.zza Falchera a Torino, di P.zza Duomo a Termini Imerese, il terzo premio per la ristrutturazione urbana dell'area Fiat di V.le Belfiore a Firenze, per la riqualificazione di P.zza Isolo a Verona e di via di Nanni a Torino. Sono stati selezionati tra i più autorevoli Architetti Contemporanei in occasione della mostra e della pubblicazione "La mano dell'architetto", organizzate e pubblicate dal FAI in collaborazione con Moleskine ed Editrice Abitare Segesta. Il nome "Mimesi" si riferisce alla porta mimetica della loro prima sede posta al numero civico 62, il cui fronte imitava l'esterno in pietra dell'edificio.

Domenico Pagnano, Giuseppe Giusto, Antonella Maggini and founded the MIMESI 62 Associated Architects studio in 1996.

They have done, do and try to make architecture in Italy by designing buildings, public spaces, interiors and furnishing accessories, focusing on flexibility and adjusting the offer to customer needs.

They won several competitions, creating the Center for music and art in Misterbianco (CT), the redevelopment of P.zza V. Veneto in Montevarchi (AR), the recovery of the former Miners' Village in S. Giovanni Valdarno (FI), the Piazza di Varlungo in Florence.

They win the first prize in the international competition for the restructuring of the PR8 area in Viareggio and for the Piazza del Santuario della Madonna delle Grazie in Curtatone, the second prize in the competitions for the urban redevelopment of the area between P.zza Martiri della Libertà and P.zza Garibaldi in Casciana Terme (Pisa), P.zza Guala and P.zza Falchera in Turin, P.zza Duomo in Termini Imerese, the third prize for the urban restructuring of the Fiat area of V. le Belfiore in Florence, for the redevelopment of P.zza Isolo in Verona and via di Nanni in Turin. They were selected among the most authoritative Contemporary Architects on the occasion of the exhibition and publication "The hand of the architect", organized and published by the FAI in collaboration with Moleskine and Editrice Abitare Segesta. The name "Mimesi" refers to the mimetic door of their first headquarters located at house number 62, the front of which imitated the stone exterior of the building.

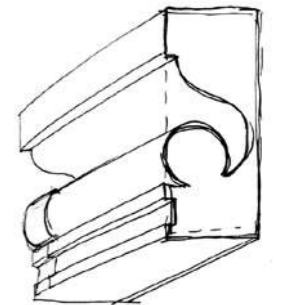
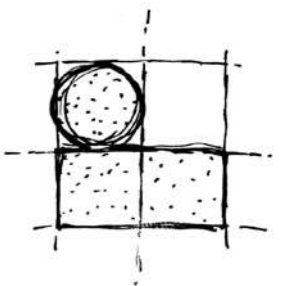
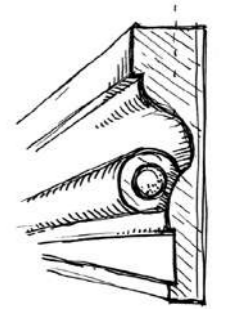

luce da terra

- novità | accanto [54](#)
- novità | verticale [58](#)
- superangolo [62](#)
- novità | astòn [66](#)
- genoa floor [70](#)

luce da tavolo

- novità | bilancia [76](#)
- biss [80](#)
- genoa table [84](#)

luce da parete

- novità | color [90](#)
- novità | figaro [94](#)
- novità | floyd [98](#)
- genoa wall [102](#)
- rialto [106](#)
- vela [110](#)

sospensioni

- olimpia [116](#)
- olimpia irid [122](#)
- altis [126](#)
- orbita [132](#)
- giotto [138](#)
- kronos [142](#)
- eracle [146](#)
- hera [150](#)
- xyz [154](#)
- stelo [160](#)
- apotema [164](#)
- davinci [168](#)
- micelangelo [174](#)
- dali [178](#)
- costellazione [182](#)
- sferetta [186](#)
- rigaled [192](#)
- segmento [198](#)
- punto [204](#)
- duetto 22 / 33 [208](#)
- titania [214](#)
- biverso [220](#)
- travled + travled point [224](#)
- microlinea + microinlinea [230](#)
- macroluce + macroinluce [234](#)
- meteora [238](#)
- pivot [242](#)
- macropivot [246](#)

spot & tris

- irid 22 – irid 33 [252](#)
- tris [256](#)

sistemi a parete

- orbita [262](#)
- davinci [266](#)
- pivot – w [270](#)
- mini pivot – w [274](#)
- j [278](#)
- float [282](#)
- eco [288](#)
- infinito [292](#)
- mancorrente [296](#)
- tryten [300](#)

soffitto parete

- olimpia [308](#)
- altis [312](#)
- orbita [316](#)
- davinci [320](#)
- micelangelo [324](#)
- link [328](#)
- link point + advanced [332](#)
- t24 + m24 [338](#)
- in + out [348](#)
- kepler [354](#)

sistemi modulari

- zero55 [364](#)
- zero75 [380](#)
- zero35 [402](#)
- zero35 – p [414](#)
- zero35 spot advanced [422](#)
- zero35 x [426](#)
- zero35 xp [436](#)
- zero35 t + zero35 m [446](#)
- zero65 + zero65 x [458](#)
- zero65 p [468](#)
- zero65 spot advanced [480](#)
- zero66 [484](#)
- q10 [492](#)
- q20 [500](#)
- structurae [510](#)
- k40 [522](#)
- k25 [530](#)
- k15 [538](#)
- s21 [546](#)
- ch012 [554](#)
- lc020 [566](#)
- lc014 [576](#)
- lc021 [592](#)
- sc015 [600](#)
- ms07 [608](#)
- ms08 [616](#)
- ms09 [624](#)
- ut01 + ut02 [636](#)
- u01 [642](#)
- u02 + u02 spot [658](#)
- u03 [680](#)
- mira [692](#)
- mc01 + mc02 [698](#)
- mf01 + mf02 [704](#)

- quadra [706](#)
- faretti
- hydria quadro [710](#)
- hydria tondo [710](#)
- flama quadro [710](#)
- flama tondo [710](#)

led new generation

- led new generation [720](#)
- mini flex led [720](#)
- led rgb [744](#)
- rgb ultraslim [744](#)
- led rgbw [744](#)
- led rgbtw [744](#)
- led tw [744](#)

accessori

- driver 24V ip20 [752](#)
- driver mA ip20 [753](#)
- driver ip67 [753](#)
- emergency driver [754](#)
- dimmer [755](#)
- light control [756](#)

“altamente evocativa”

ACCANTO è una lampada da parete altamente evocativa, formata dall'incrocio di due porzioni di circonferenze accostate tra di loro. Esse sono realizzate con un profilo in alluminio centinato a sezione rettangolare di 5x1,2 centimetri, posto perpendicolarmente rispetto alla parete e distanziato di 2 cm tramite piccoli mottoli.

La lampada prevede diverse combinazioni di accensione indipendenti, sia anteriormente che posteriormente, le quali consentono di personalizzare le varie configurazioni luminose in base al gusto e alla necessità del fruitore.

La luce che l'oggetto produce, per effetto di quella naturale nell'ambiente, fa parte della poetica compositiva proposta. Quando la luce naturale e quella artificiale interagiscono, si creano effetti particolari sulla superficie che tendono alla vibrazione e rarefazione della scena.

ACCANTO is a highly evocative wall lamp, formed by the intersection of two portions of circumferences placed side by side. They are made with an aluminum profile with a rectangular section of 5x1.2 cm, placed perpendicular to the wall and spaced by 2 cm by means of small mottoli.

The lamp provides different combinations of independent switching, both front and rear, which allow you to customize the various light configurations according to the taste and needs of the user.

The light that the object produces, as a result of the natural light in the environment, is part of the proposed compositional poetics. When natural and artificial light interact, particular effects are created on the surface that tend to the vibration and rarefaction of the scene.

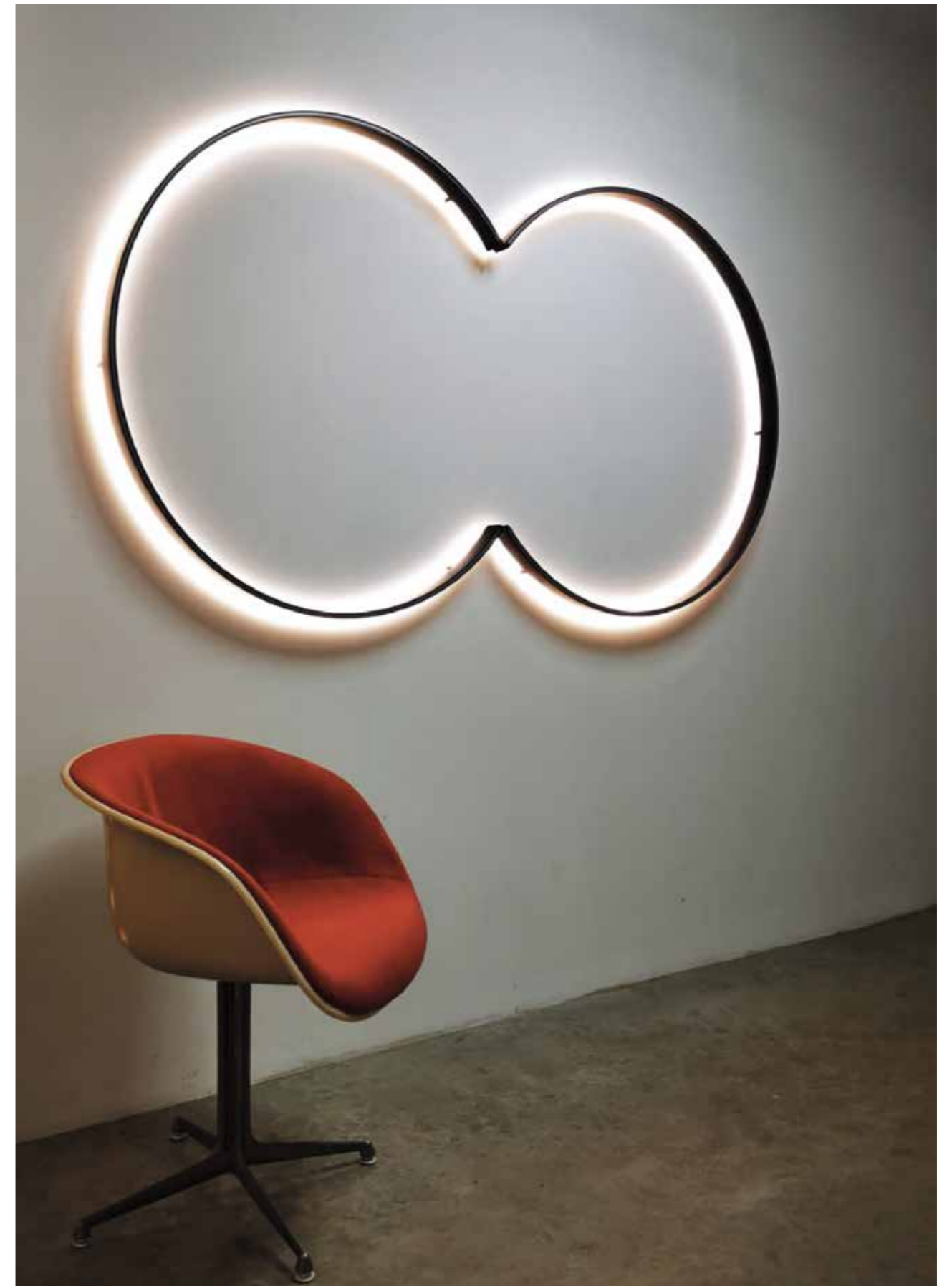



DATI TECNICI
TECHNICAL DATA

	192x110 cm (lxh)	135x75 cm (lxh)	95x55 cm (lxh)
Nominal LED Flux:	34560 lm	23200 lm	16200 lm
Flux Tot:	27650 lm	18550 lm	12960 lm
Output:	150 lm/W	3000 K	3000 K
CCT:	3000 K	3000 K	3000 K
CRI:	>90	>90	>90
Power:	12.0W/m	12.0W/m	12.0W/m
Power Tot:	230 W	155 W	108 W
Weight:	6,90 Kg	4,70 Kg	3,50 Kg

Profilo/Profile: Alluminio/aluminum

Cover: Opale/Opal

PER LA CUSTOMIZZAZIONE DEL PRODOTTO
RIVOLGERSI AL NOSTRO UFFICIO TECNICO
FOR THE CUSTOMIZATION OF THE PRODUCT,
PLEASE CONTACT OUR TECHNICAL OFFICE

EQUIPAGGIATE CON 4 DRIVER DALI/DIMMER
PUSH PER OGNI SINGOLO MODELLO
EQUIPPED WITH 4 DALI / DIMMER PUSH
DRIVERS FOR EVERY SINGLE MODELLO

		192x110 cm (lxh)	135x75 cm (lxh)	95x55 cm (lxh)
FINITURA STRUTTURA FINISHES	COLORE CAVO WIRE COLOR	CODICE 3000K CODE 3000k	CODICE 3000K CODE 3000k	CODICE 3000K CODE 3000k
NERO CARAVAGGIO BLACK	NERO BLACK	405504A110	405504A075	405504A055
FINITURA STRUTTURA FINISHES	COLORE CAVO WIRE COLOR	CODICE 2700K CODE 2700k	CODICE 2700K CODE 2700k	CODICE 27000K CODE 2700k
NERO CARAVAGGIO BLACK	NERO BLACK	405404A110	405404A075	405404A055

“binomio affascinante tra luci e ombre”

VERTICALE è il risultato di un processo di ricerca e innovazione nel quale il design italiano coniuga bellezza, funzionalità e semplicità. Il suo corpo in estruso d'alluminio a forma circolare, in cui la parte luminosa viene emessa solo per il 50% della sua superficie, per mezzo di led coperto da diffusore metacrilato opale. Questo crea un binomio affascinante tra luci ed ombre perfetto per tutti gli ambienti domestici, di relax o di business.

VERTICALE is the result of a research and innovation process in which Italian design combines beauty, functionality and simplicity. Its circular-shaped extruded aluminum body, in which the luminous part is emitted only for 50% of its surface, by means of LEDs covered by an opal methacrylate diffuser. This creates a fascinating combination of light and shadow perfect for all domestic, relaxation or business environments.





DATI TECNICI
TECHNICAL DATA

	270 cm	300 cm
Nominal LED Flux:	4860 lm	5400 lm
Flux Tot:	3888 lm	4320 lm
Output:	150 lm/W	150 lm/W
CCT:	3000 K	3000 K
CRI:	>90	>90
Power:	12.0W/m	12.0W/m
Power Tot:	32.4W	36.0W
Weight:	1,08 Kg	1.20 Kg

Profilo/Profile: Alluminio/aluminum

Cover: Opale/Opal

DRIVER A SPINA INCLUSO
PLUG DRIVER INCLUDED

INTERRUTTORE VARIALUCE DIMMER A PEDALE
FOOT SWITCH DIMMER SWITCH

PER LA CUSTOMIZZAZIONE DEL PRODOTTO
RIVOLGERSI AL NOSTRO UFFICIO TECNICO
FOR THE CUSTOMIZATION OF THE PRODUCT,
PLEASE CONTACT OUR TECHNICAL OFFICE

FINITURA STRUTTURA
FINISHES

- GRIGIO VESUVIO ANTHRACITE
- ARGILLA CLAY
- BIANCO INTONACO/WHITE
- NERO CARAVAGGIO BLACK
- MOKA MOCHA
- ORO CALIFORNIA GOLD
- ARGENTO COMETA/SILVER COMET
- TITANIO/TITANIUM
- BRONZO RIACI/RIACI BRONZE
- VERDE COSTA/GREEN COAST
- TERRA SENESE SENESE EARTH

COLORE CAVO
WIRE COLOR

- NERO
BLACK

	270 cm	300 cm
	CODICE 2700K CODE 2700K	CODICE 3000K CODE 3000K
	135400V270	135500V270
	135401V270	135501V270
	135403V270	135503V270
	135404V270	135504V270
	135405V270	135505V270
	135409V270	135509V270
	135412V270	135512V270
	135414V270	135514V270
	135415V270	135515V270
	135416V270	135516V270
	135417V270	135517V270
	CODICE 2700K CODE 2700K	CODICE 3000K CODE 3000K
	135400V300	135500V300
	135401V300	135501V300
	135403V300	135503V300
	135404V300	135504V300
	135405V300	135505V300
	135409V300	135509V300
	135412V300	135512V300
	135414V300	135514V300
	135415V300	135515V300
	135416V300	135516V300
	135417V300	135517V300



“concetto spaziale”

È una lampada da terra a luce indiretta dedicata specificatamente agli angoli “aperti e chiusi” esistenti negli ambienti interni del costruito. L’idea nasce dal desiderio di voler sottolineare l’importanza di un elemento da sempre utilizzato nel lessico architettonico semplicemente illuminandolo.

It’s a floor lamp with indirect light specifically dedicated to the “open and closed” corners existing in the interior of the building. The idea stems from the desire to emphasize the importance of an element that has always been used in the architectural lexicon simply by illuminating it.

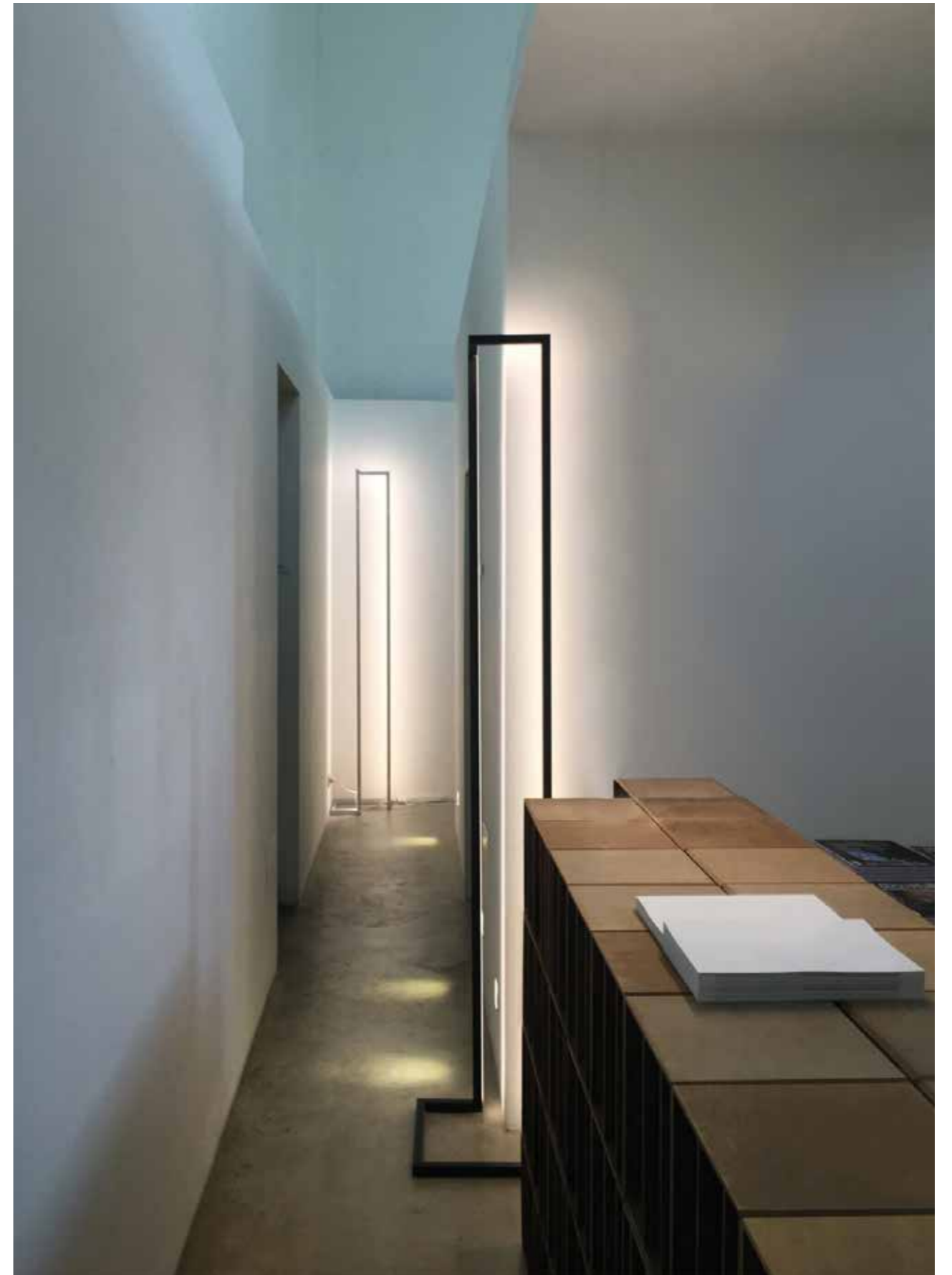



DATI TECNICI TECHNICAL DATA	VERSIONE VERSION	FINITURA STRUTTURA FINISHES	COLORE CAVO WIRE COLOR	CODICE CODE
Nominal LED Flux: 8340 lm Flux Tot: 6674 lm Output: 158 lm/W CCT: 3000 K CRI: >90 Power Tot: 53.0W Hight: 230 cm Weight: 5.00 Kg Profile: alluminio/aluminum Cover: opale/opal		BIANCO INTONACO/WHITE NERO CARAVAGGIO/BLACK	NERO BLACK	255503E 255504E
		BIANCO INTONACO/WHITE NERO CARAVAGGIO/BLACK	NERO BLACK	255503N 255504N

DRIVER A SPINA INCLUSO
PLUG DRIVER INCLUDED

INTERRUTTORE VARIALUCE DIMMER A PEDALE
FOOT SWITCH DIMMER SWITCH

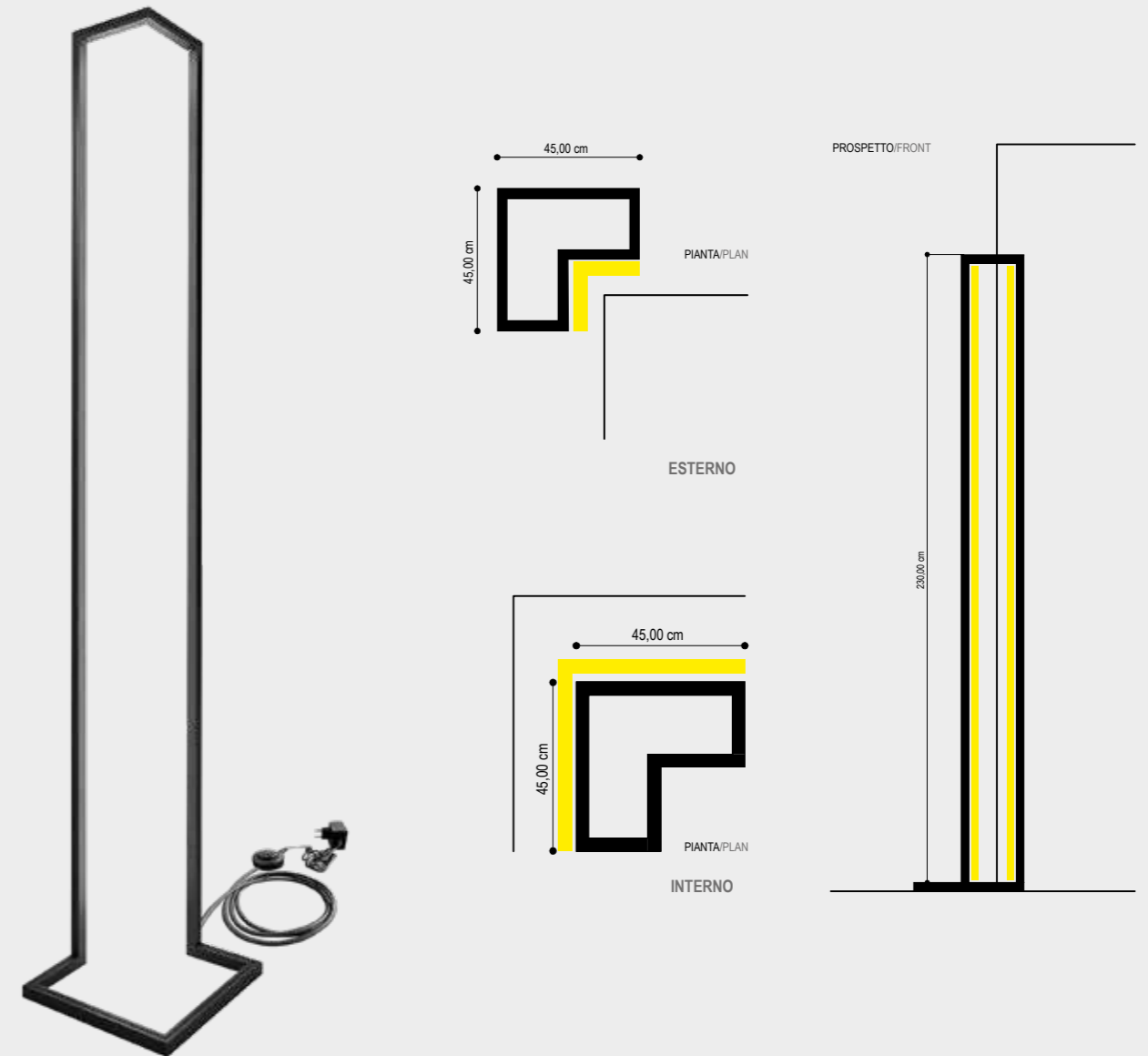

PER LA CUSTOMIZZAZIONE DEL PRODOTTO RIVOLGERSI AL NOSTRO UFFICIO TECNICO
FOR THE CUSTOMIZATION OF THE PRODUCT, PLEASE CONTACT OUR TECHNICAL OFFICE



“quattro metri di luce”

Aston dal veneto asta, nel suo nome è racchiuso il concetto di base a cui si è ispirato il progettista, creare una piantana che si sviluppasse in altezza in grado di raggiungere dimensioni generose fino a 4mt.

Entra a pieno titolo nella filosofia della Design Luce, cioè, creare prodotti flessibili in grado di aiutare gli attori del settore ad illuminare spazi in cui è richiesto un prodotto non di uso comune, capace di inserirsi nell'architettura con discrezione e personalità. Costruita in estruso d'alluminio equipaggiata con una base in acciaio molto solida e al contempo ben proporzionata alle sue dimensioni.

Aston from the Venetian asta, its name encapsulates the basic concept that inspired the designer, to create a floor lamp that develops in height and can reach generous dimensions up to 4mt.

It is fully in line with the philosophy of Design Luce, that is, to create flexible products that can help the players in the industry to illuminate spaces where it is required a product not in common use, able to fit into the architecture with discretion and personality. Built in extruded aluminum equipped with a steel base very solid and at the same time well-proportioned to its size.

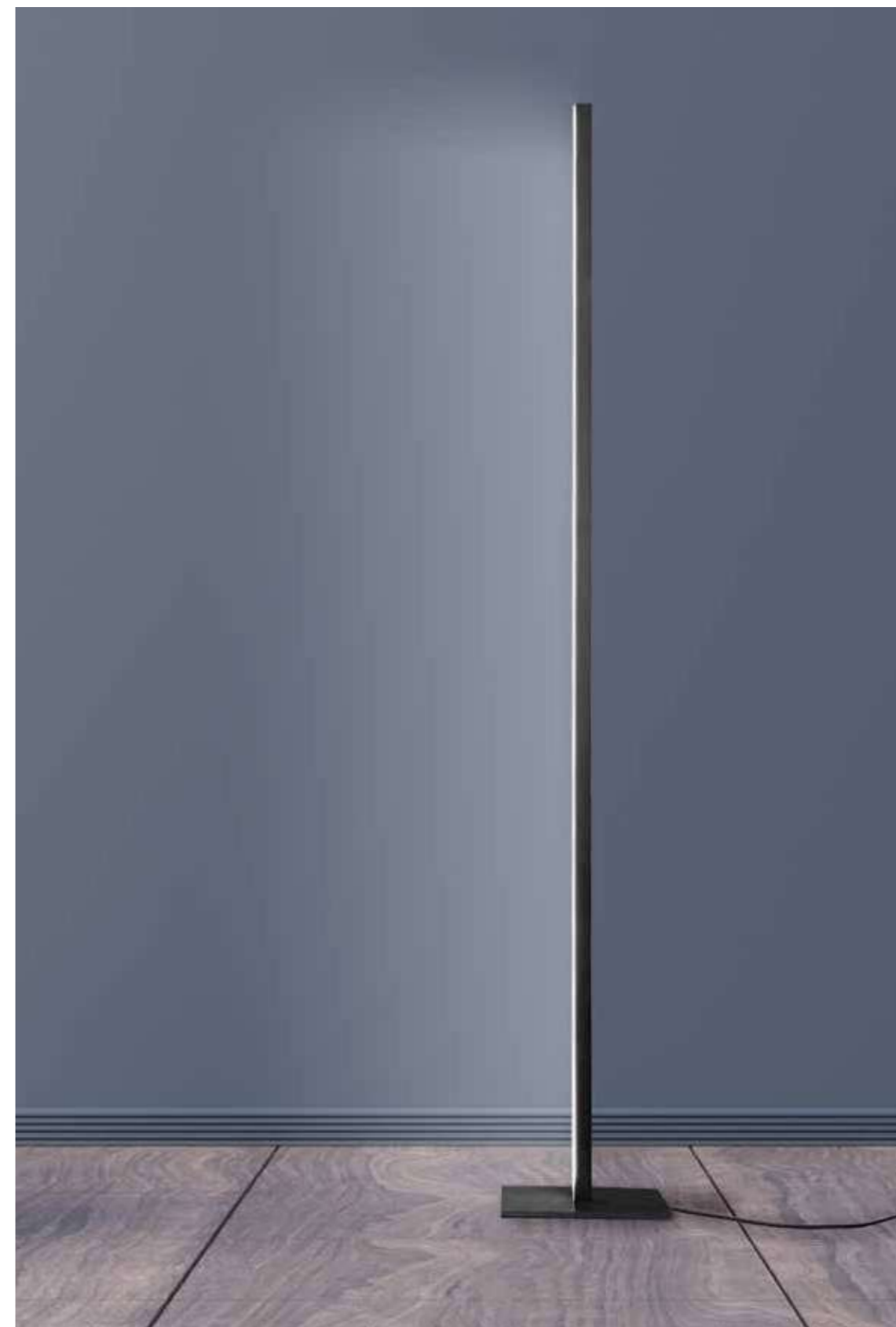

DATI TECNICI
 TECHNICAL DATA

LED Flux: 4400 lm
 Flux Tot: 3300 lm
 Output: 110 lm/W
 CCT: 3000 K
 CRI: >95
Power Tot: 40.0W
 Hight: 200 cm
 Weight: 7.00 Kg
 Profile: alluminio/aluminum
 Cover: opale/opal

FINITURA STRUTTURA
 FINISHES

ARGILLA CLAY
 BIANCO INTONACO/WHITE
 NERO CARAVAGGIO/BLACK
 ORO CALIFORNIA/GOLD
 ARGENTO COMETA/SILVER COMET
 TITANIO/TITANIUM
 BRONZO RIACI/RIACI BRONZE

COLORE CAVO
 WIRE COLOR

NERO BLACK
 NERO BLACK
 NERO BLACK
 NERO BLACK
 NERO BLACK
 NERO BLACK
 NERO BLACK

CODICE
 CODE

252601K
 252603K
 252604K
 252609K
 252612K
 252614K
 252615K

ALIMENTATORE DIMMERABILE INCLUSO
 DIMMABLE POWER SUPPLY INCLUDED

DRIVER A SPINA INCLUSO
 PLUG DRIVER INCLUDED

INTERRUTTORE VARIALUCE DIMMER A PEDALE
 FOOT SWITCH DIMMER SWITCH

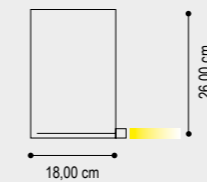

PIANTA/PLAN

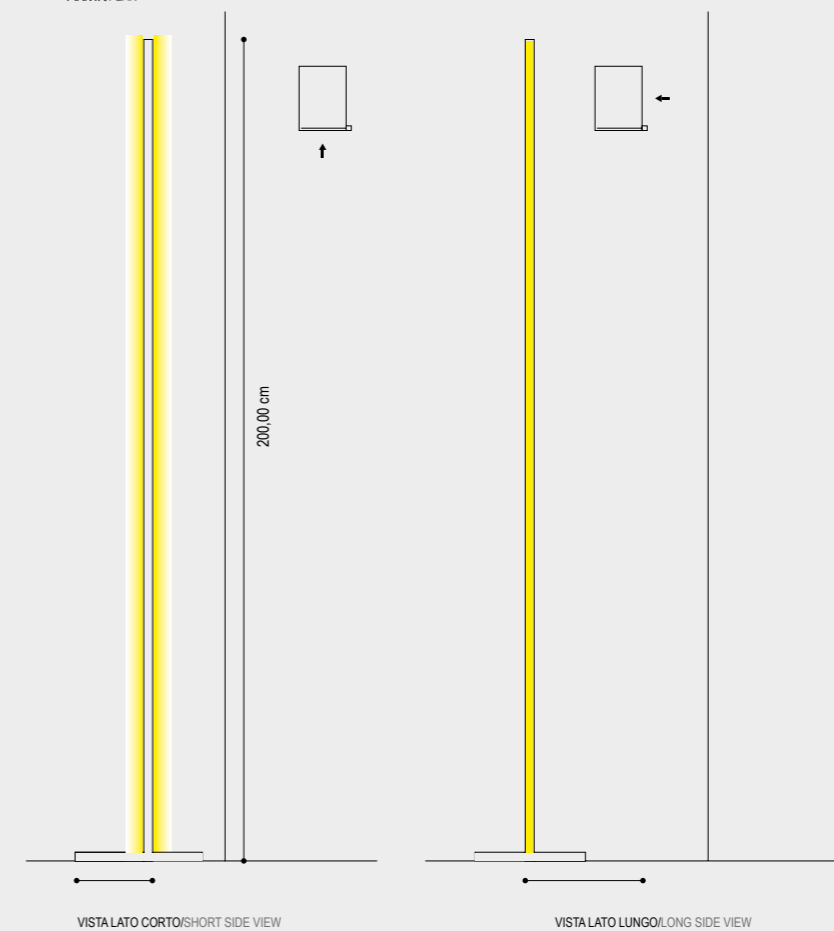

VISTA LATO CORTO/SHORT SIDE VIEW

VISTA LATO LUNGO/LONG SIDE VIEW

PER LA CUSTOMIZZAZIONE DEL PRODOTTO RIVOLGERSI AL NOSTRO UFFICIO TECNICO
 FOR THE CUSTOMIZATION OF THE PRODUCT, PLEASE CONTACT OUR TECHNICAL OFFICE



“la luce ovunque”

Genoa una lampada minimale e al contempo studiata per portare la luce ovunque, a terra sui tavoli sulle pareti. Disegnata con base e stelo a sezione rettangolare, congiunti da un elegante cavo in acciaio, questo ha una doppia funzione sia operativa on-off che estetica rendendo la lampada simile alla vela Genoa a cui ci siamo ispirati.

Genoa a minimal lamp and at the same time designed to bring light everywhere, on the floor on the tables on the walls. Designed with a rectangular base and stem, joined by an elegant steel cable, this has a dual function, both on-off and aesthetic, making the lamp similar to the Genoa sail we were inspired by.





DATI TECNICI TECHNICAL DATA	FINITURA STRUTTURA FINISHES	COLORE CAVO WIRE COLOR	CODICE CODE
LED Flux: 4400 lm Flux Tot: 3300 lm Output: 110 lm/W CCT: 3000 K CRI: >95 Power Tot: 40.0W Height: 200 cm Weight: 7.00 Kg Profile: alluminio/aluminum Cover: opale/opal	ARGILLA CLAY	NERO BLACK	252601G
	BIANCO INTONACO/WHITE	NERO BLACK	252603G
	NERO CARAVAGGIO BLACK	NERO BLACK	252604G
	ORO CALIFORNIA/GOLD	NERO BLACK	252609G
	ARGENTO COMETA/SILVER COMET	NERO BLACK	252612G
	TITANIO/TITANIUM	NERO BLACK	252614G
	BRONZO RIACI/RIACI BRONZE	NERO BLACK	252615G

ALIMENTATORE DIMMERABILE INCLUSO
DIMMABLE POWER SUPPLY INCLUDED

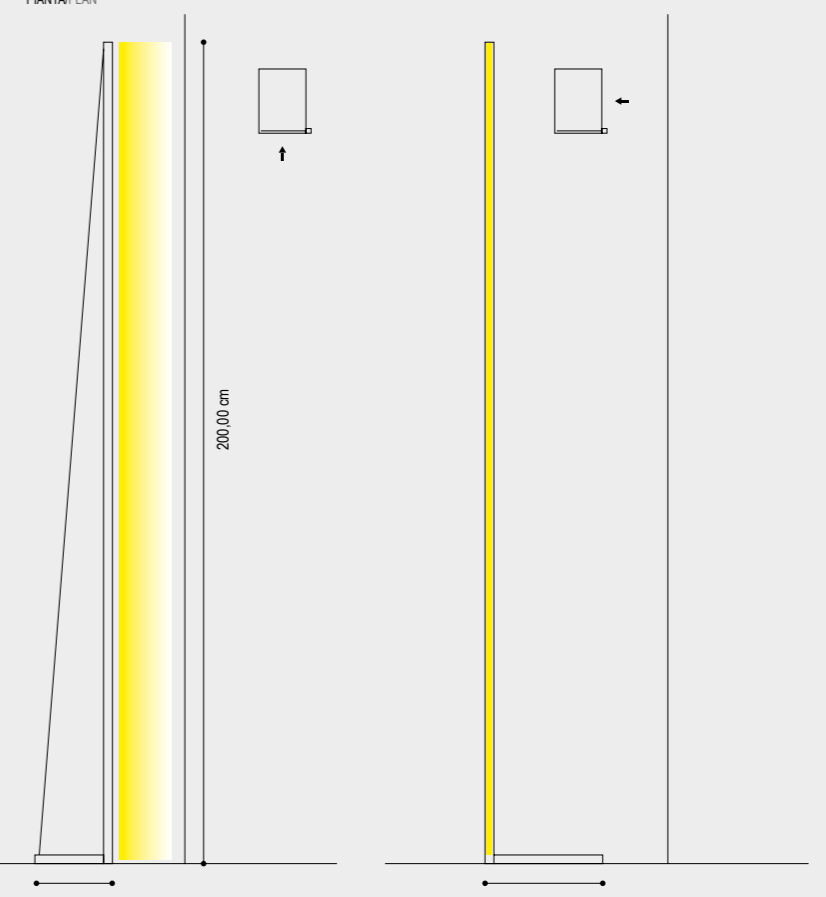
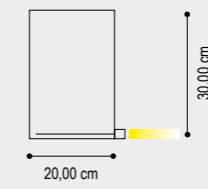

“illumina per tutta la sua lunghezza”

Normalmente una lampada da tavolo illumina una superficie circoscritta. Con Bilancia, Design Luce ha voluto rivedere questo concetto. Abbiamo studiato e sviluppato una lampada che fosse capace di illuminare una superficie per tutta la sua lunghezza in cui tecnica e design fossero esaltati. Costruita con tecnologia in estruso d'alluminio, in cui uno stelo viene sorretto da un braccio basculante costruito anche esso in alluminio, ed equipaggiato con lenti spot 15° e led CRI >97. Bilancia è una lampada professionale adatta a situazioni in cui il è richiesto un comfort visivo severo.

Normally a table lamp illuminates a circumscribed surface. With Bilancia, Design Luce wanted to revise this concept. We studied and developed a lamp capable of illuminating a surface in its entirety in which technique and design are exalted. Built with extruded aluminium technology, in which a stem is surmounted by a pivoting arm also made of aluminium, and equipped with 15° spot lenses and CRI >97 LEDs. Bilancia is a professional luminaire suitable for situations where strict visual comfort is required.



bilancia

novità

new



bilancia

scheda tecnica

DATI TECNICI
TECHNICAL DATA

	70 cm	100 cm
Nominal LED Flux:	1170 lm	1820 lm
Flux Tot:	936 lm	1456 lm
Output:	130 lm/W	130 lm/W
CCT:	3000 K	3000 K
CRI:	>97	>90
Power Tot:	9.00W	14.0W
Weight:	2,00 Kg	2.80 Kg

Profilo/Profile: Alluminio/aluminum

Cover: Opale/Opal

PER LA CUSTOMIZZAZIONE DEL PRODOTTO RIVOLGERSI AL NOSTRO UFFICIO TECNICO
FOR THE CUSTOMIZATION OF THE PRODUCT, PLEASE CONTACT OUR TECHNICAL OFFICE

DRIVER A SPINA INCLUSO
PLUG DRIVER INCLUDED

ACCENSIONE TOUCH
TOUCH IGNITION

FINITURA STRUTTURA
FINISHES

COLORE CAVO
WIRE COLOR

CODICE 2700K
CODE 2700K

CODICE 3000K
CODE 3000K

ORO CALIFORNIA/GOLD	NERO/BLACK	2596090070	2597090070
ORO CALIFORNIA/GOLD	NERO/BLACK	2596090100	2597090100

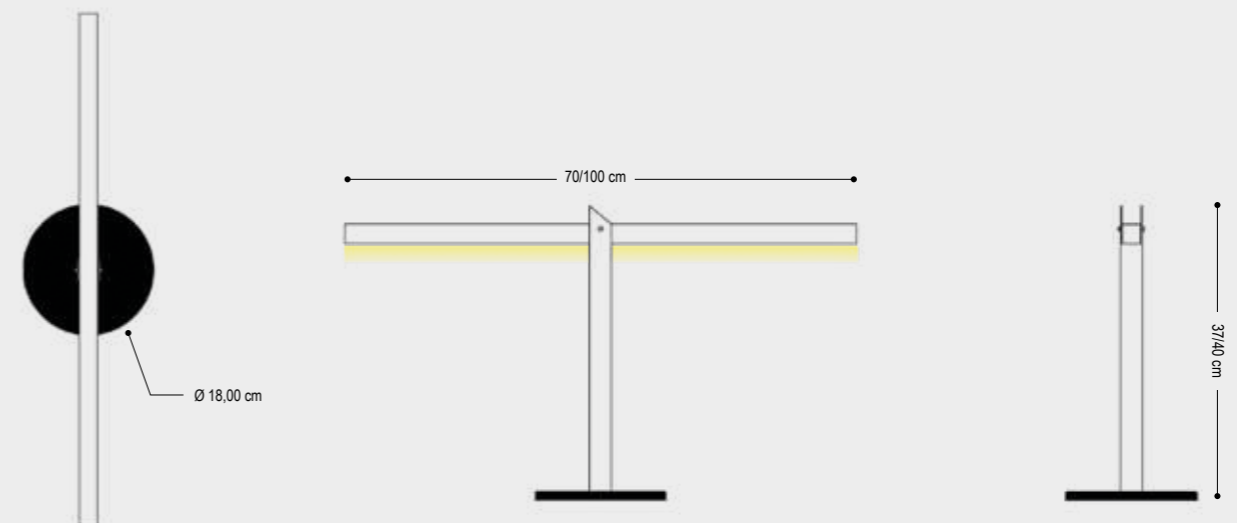

“geometrie astratte e luminose”

BISS prosegue la ricerca iniziata SUPERANGOLO. Una serie di geometrie luminose e astratte nello spazio alla ricerca di un equilibrio visivo ed emozionale da trasmettere. Un connubio tra luce e forma che parte da diagrammi compositivi precisi per potersi successivamente allontanare verso libere interpretazioni.

The BISS wall, ceiling and support lamp continues the research begun with SUPERANGOLO. A series of luminous and abstract geometries in space in search of a visual and emotional balance to be transmitted. A combination of light and form that starts from precise compositional diagrams to be able to move away towards free interpretations.

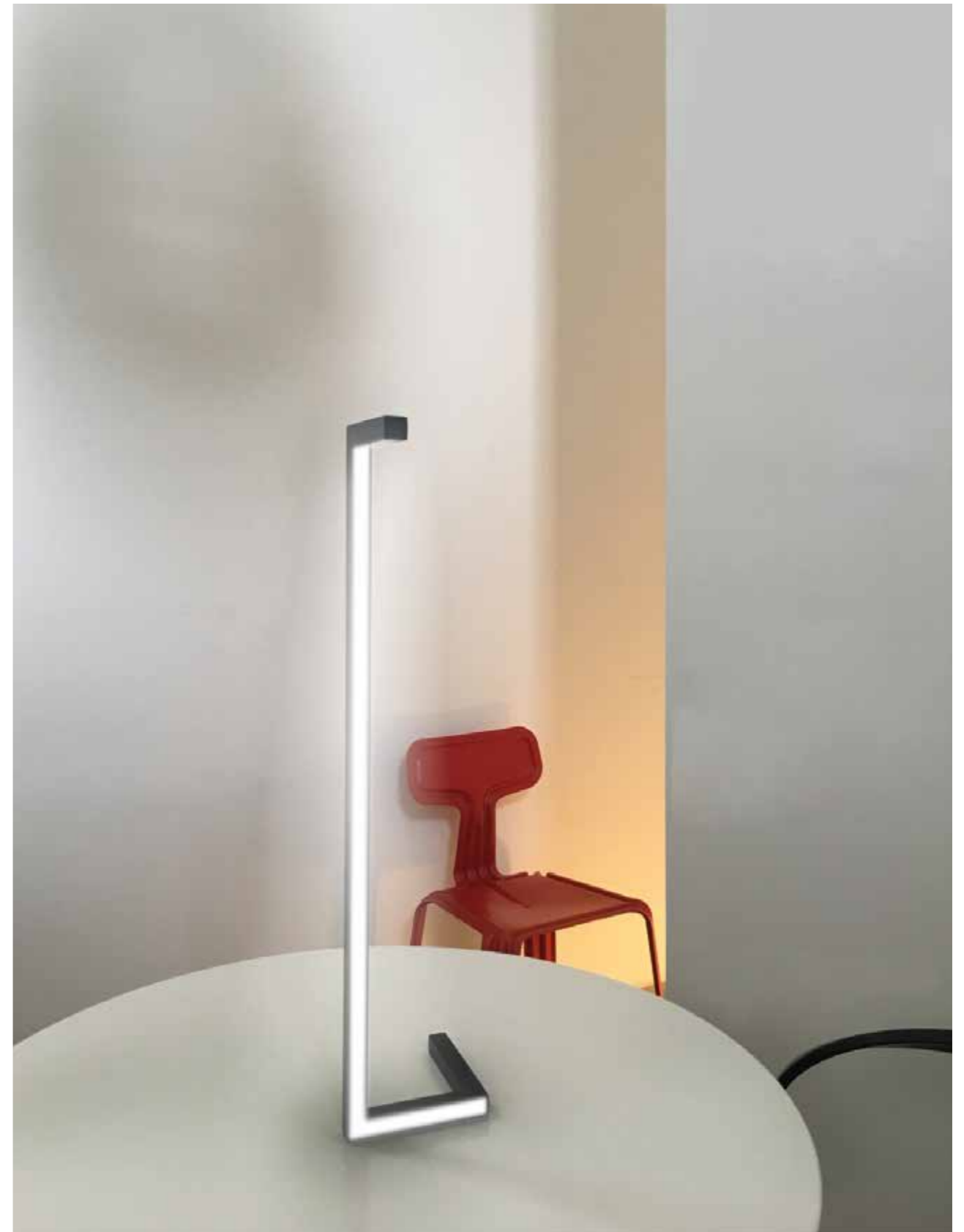

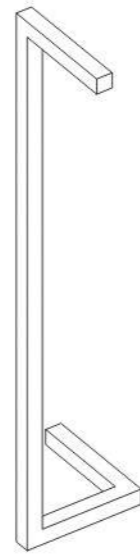

p - a version



s - f version

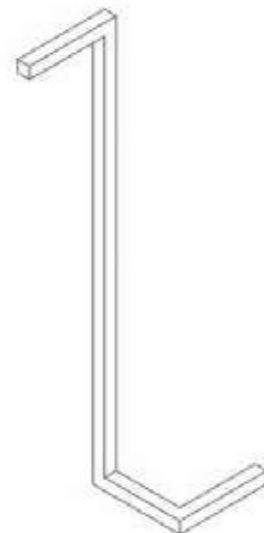

t - r version

DATI TECNICI TECHNICAL DATA	VERSIONE VERSION	FINITURA STRUTTURA FINISHES	COLORE CAVO WIRE COLOR	CODICE CODE
Nominal LED Flux: 1625 lm Flux Tot: 1300 lm Output: 158 lm/W CCT: 3000 K CRI: >90 Power Tot: 13.0W Weight: 1.50 Kg Profile: alluminio/aluminum Cover: opale/opal DIMENSIONI / DIMENSIONS: BASE/BASE (B) 22,0 cm x 22,0 cm ALTEZZA/ HEIGHT (H) 50,0 cm l		BIANCO INTONACO/WHITE BIANCO INTONACO/WHITE BIANCO INTONACO/WHITE NERO CARAVAGGIO/BLACK NERO CARAVAGGIO/BLACK NERO CARAVAGGIO/BLACK	NERO/BLACK	255503T 255503P 255503S 255504T 255504P 255504S
		BIANCO INTONACO/WHITE BIANCO INTONACO/WHITE BIANCO INTONACO/WHITE NERO CARAVAGGIO/BLACK NERO CARAVAGGIO/BLACK NERO CARAVAGGIO/BLACK	NERO/BLACK	255503R 255503A 255503F 255504R 255504A 255504F

VERSIONE P - S / A - F: ALIMENTATORE ON/OFF INCLUSO
 P - S / A - F VERSION: POWER SUPPLY ON/OFF INCLUDED

VERSIONE T / R: ALIMENTATORE SPINA INCLUSO
 T / R VERSION: PLUG POWER SUPPLY INCLUDED
 *ACCENSIONE TOUCH
 TOUCH IGNITION

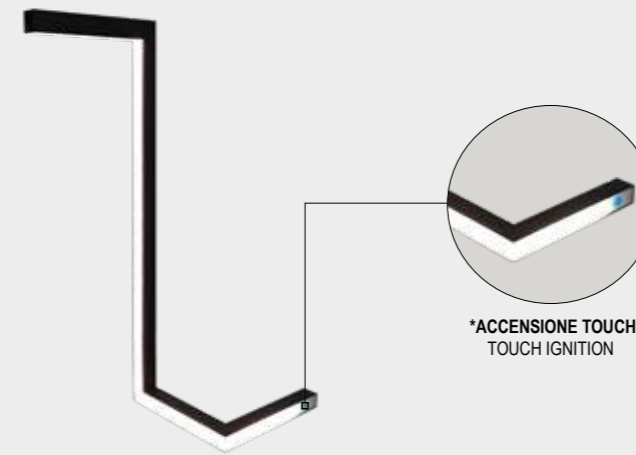

*ACCENSIONE TOUCH
 TOUCH IGNITION

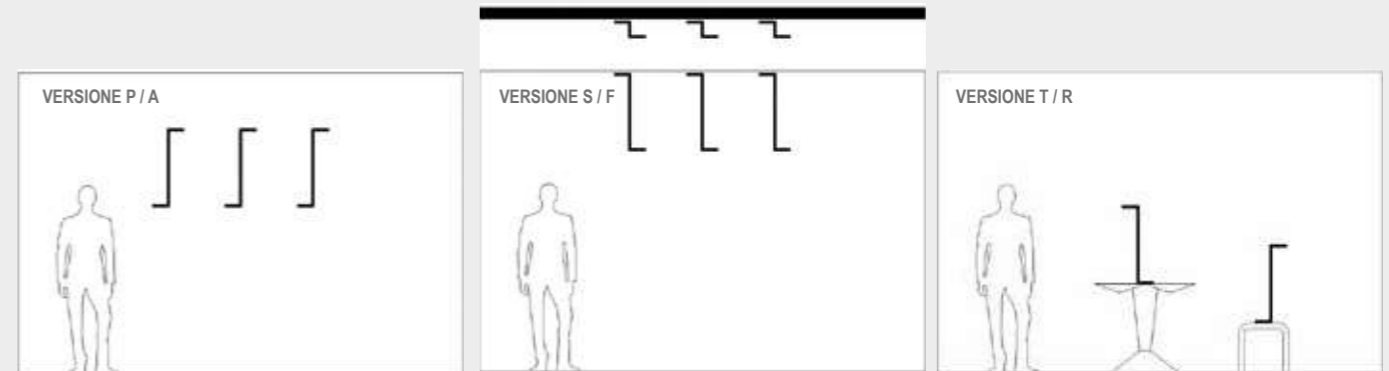

“la lampada minimale”

GENOA una lampada minimale e al contempo studiata per portare la luce ovunque, a terra sui tavoli sulle pareti. Disegnata con base e stelo a sezione rettangolare, congiunti da un elegante cavo in acciaio, questo ha una doppia funzione sia operativa on-off che estetica rendendo la lampada simile alla vela Genoa a cui ci siamo ispirati.

GENOA a minimal lamp and at the same time designed to bring light everywhere, on the floor on the tables on the walls. Designed with a rectangular base and stem, joined by an elegant steel cable, this has a dual function, both on-off and aesthetic, making the lamp similar to the Genoa sail we were inspired by.





DATI TECNICI TECHNICAL DATA	FINITURA STRUTTURA FINISHES	COLORE CAVO WIRE COLOR	CODICE CODE
Nominal LED Flux: 948 lm Flux Tot: 758 lm Output: 158 lm/W CCT: 3000 K CRI: >90 Power Tot: 6.0W Height: 50 cm Weight: 3.00 Kg Profile: alluminio/aluminum Cover: opale/opal	<ul style="list-style-type: none"> ARGILLA CLAY BIANCO INTONACO/WHITE NERO CARAVAGGIO BLACK ORO CALIFORNIA/GOLD ARGENTO COMETA/SILVER COMET TITANIO/TITANIUM BRONZO RIACI/RIACI BRONZE 	<ul style="list-style-type: none"> NERO BLACK NERO BLACK NERO BLACK NERO BLACK NERO BLACK NERO BLACK NERO BLACK 	<ul style="list-style-type: none"> 095501T 095503T 095504T 095509T 095512T 095514T 095515T

ALIMENTATORE DIMMERABILE INCLUSO
DIMMABLE POWER SUPPLY INCLUDED

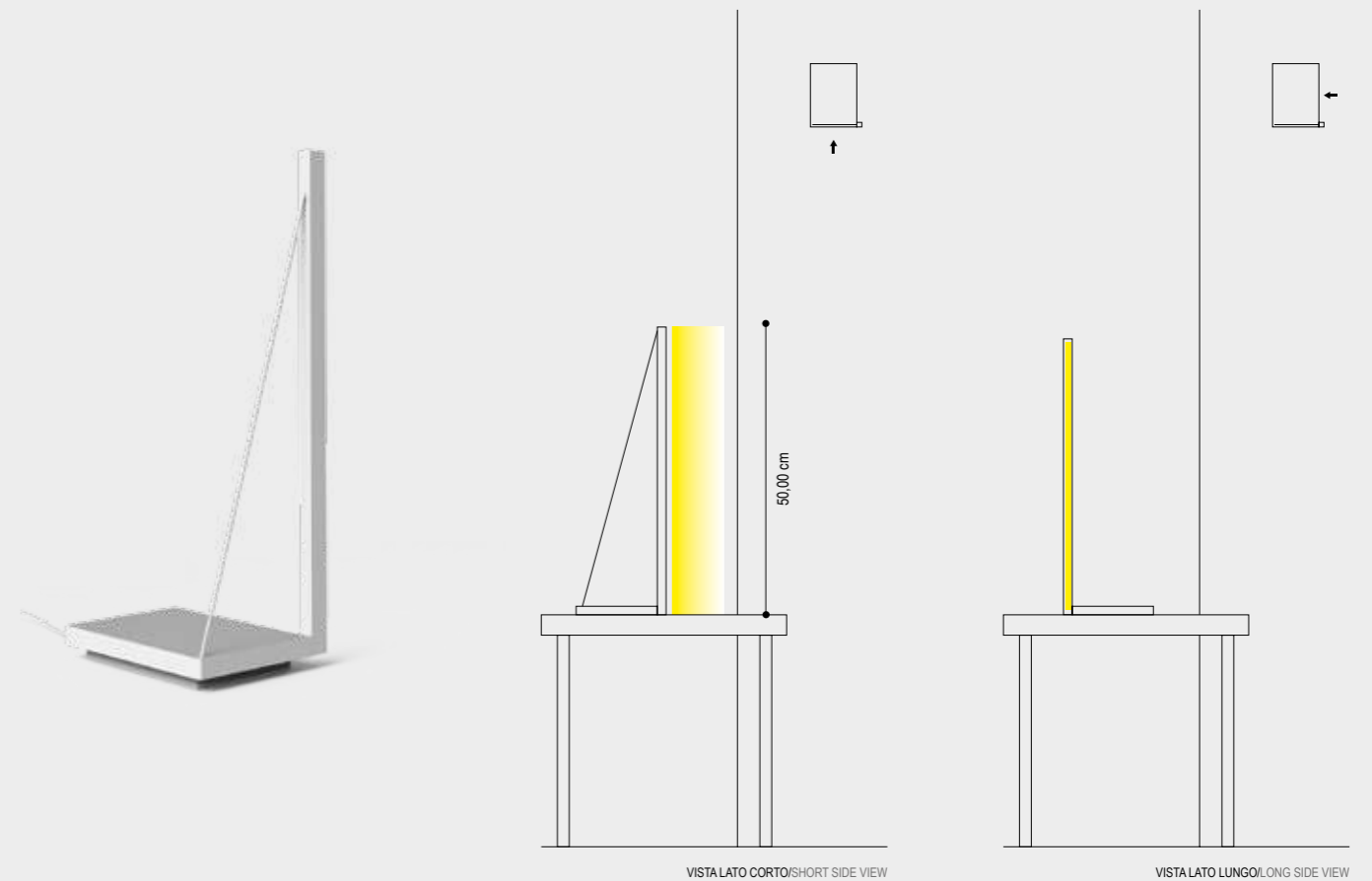
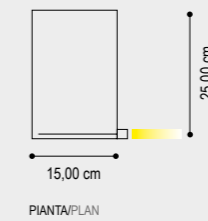

“semplice, essenziale e moderno”

COLOR...semplice essenziale e moderno, costruito con tecnologia in estruso d'alluminio a luce indiretta ed orientabile, viene proposto in diverse colorazioni che gli permettono di integrarsi in tutti gli spazi architettonici con discrezionalità ed eleganza.

COLOR...simple, essential and modern, built with extruded aluminium technology with indirect and adjustable light, it is available in different colours that allow it to integrate into all architectural spaces with discretion and elegance.

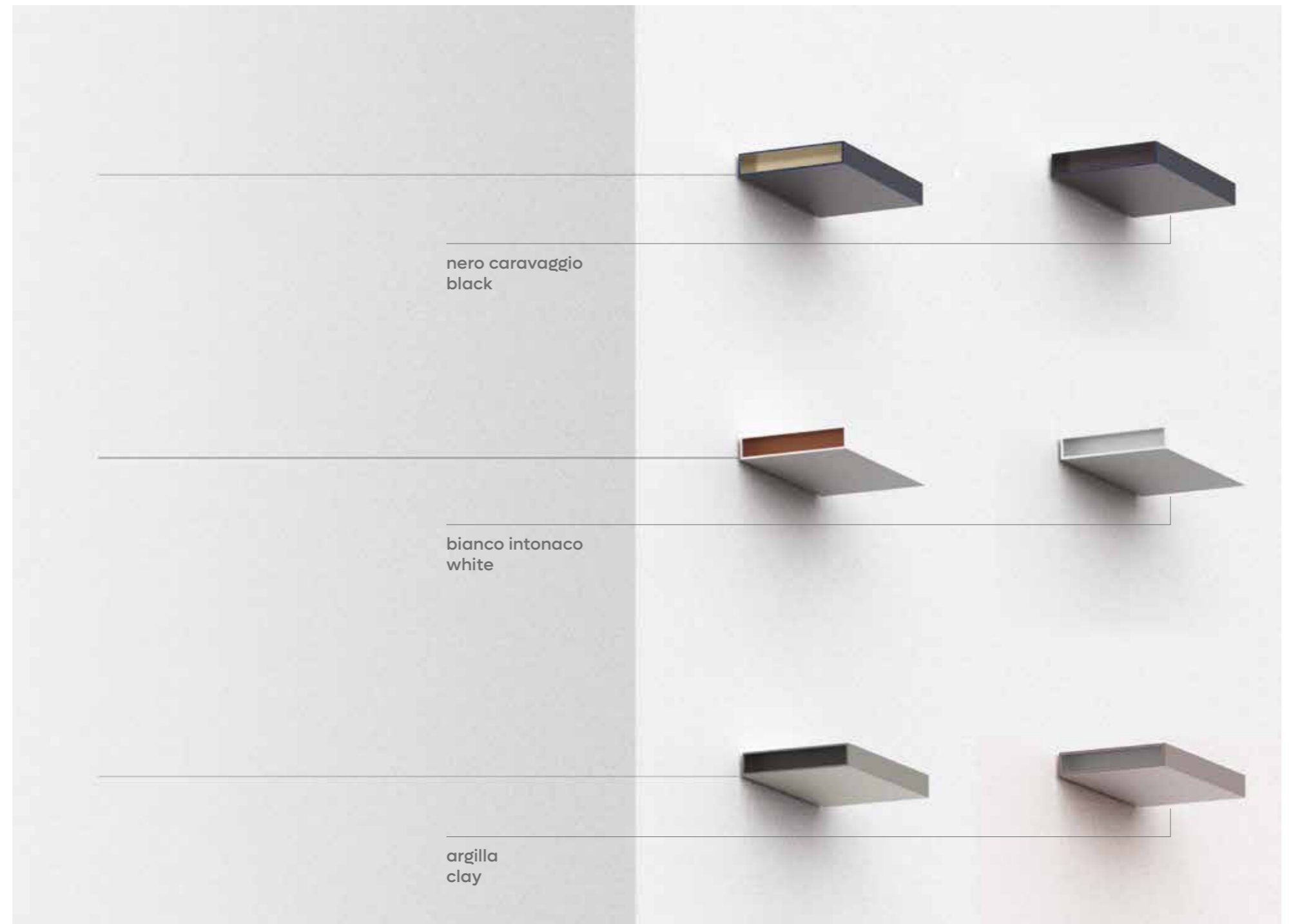

color

novità

new

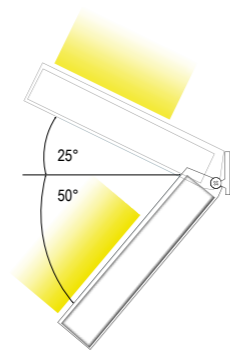
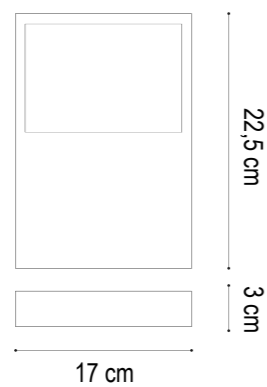

color

scheda tecnica

DATI TECNICI
TECHNICAL DATA

	1 cm	25,5 cm
Nominal LED Flux:	15600 lm/m	3900 lm
Flux Tot:	12480 lm/m	3120 lm
Output:	130 lm/W	130 lm/W
CCT:	3000 K	3000 K
CRI:	>90	>90
Power:	120.0W/m	30W
Weight:	1.20 Kg/m	0.3 Kg

Profilo/Profile: Alluminio/aluminum

Cover: Opale/Opal

ALIMENTATORE ON/OFF INCLUSO
DRIVER ON/OFF INCLUDED

FINITURA STRUTTURA FINISHES	1 cm DRIVER NON INCLUSO/ DIMMABLE NOT INCLUDED		TESTATE DI CHIUSURA / DEAD ENDS 2 PEZZI/2 PIECES CODICE CODE
	CODICE 2700K CODE 2700K	CODICE 3000K CODE 3000K	
ARGILLA/CLAY	168001C001	168101C001	160401
BIANCO INTONACO/WHITE	168003C001	168103C001	160403
NERO CARAVAGGIO/BLACK	168004C001	168104C001	160404
MOKA/MOCHA	168005C001	168105C001	160405
CROMO/CHROME	168008C001	168108C001	160408
ORO CALIFORNIA/GOLD	168009C001	168109C001	160409
TITANIO/TITANIUM	168014C001	168114C001	160414
BRONZO RIACI/RIACI BRONZE	168015C001	168115C001	160415
VERDE COSTA/GREEN COAST	168016C001	168116C001	160416

N.B.: IL PRODOTTO PUÒ ESSERE CUSTOMIZZATO CON UNA MISURA MINIMA DI 5CM
P.N.: THE PRODUCT CAN BE CUSTOMIZED WITH 5CM MINIMUM SIZE

FINITURA STRUTTURA FINISHES	25,5 cm DRIVER ON/OFF INCLUSO/DIMMABLE ON/OFF INCLUDED	
	CODICE 2700K CODE 2700K	CODICE 3000K CODE 3000K
ARGILLA/CLAY	168001C025	168101C025
BIANCO INTONACO/WHITE	168003C025	168103C025
NERO CARAVAGGIO/BLACK	168004C025	168104C025
MOKA/MOCHA	168005C025	168105C025
CROMO/CHROME	168008C025	168108C025
ORO CALIFORNIA/GOLD	168009C025	168109C025
TITANIO/TITANIUM	168014C025	168114C025
BRONZO RIACI/RIACI BRONZE	168015C025	168115C025
VERDE COSTA/GREEN COAST	168016C025	168116C025
ARGENTO C.+GRIGIO V./SILVER COMET+ANTHRACITE	168020C025	168120C025
BIANCO E ARAMEN/WHITE AND COPPER	168031C025	168131C025
BIANCO E CROMO/WHITE AND CHROME	168038C025	168138C025
NERO E ORO/BLACK AND GOLD	168049C025	168149C025

N.B.: NEL CODICE SONO COMPRESSE LE TESTATE DI CHIUSURA.
P.N.: THE CODE INCLUDES CLOSING WARHEADS.



“design rigoroso”

FIGARO ... costruito con tecnologia in estruso d'alluminio a luce indiretta ed orientabile, viene proposto con led ad altissima efficienza. Il suo design rigoroso e al contempo accattivante, lo rendono estremamente adatto ad essere inserito in corridoi, sale o in ambiti in cui è richiesta una luce indiretta capace di valorizzare spazi architettonici come volte soffitti affrescati.

FIGARO ... built using extruded aluminium technology with indirect and adjustable light, is offered with high efficiency LEDs. Its rigorous yet attractive design makes it extremely suitable for use in corridors, halls or areas where indirect light is required to enhance architectural spaces such as vaulted and frescoed ceilings.

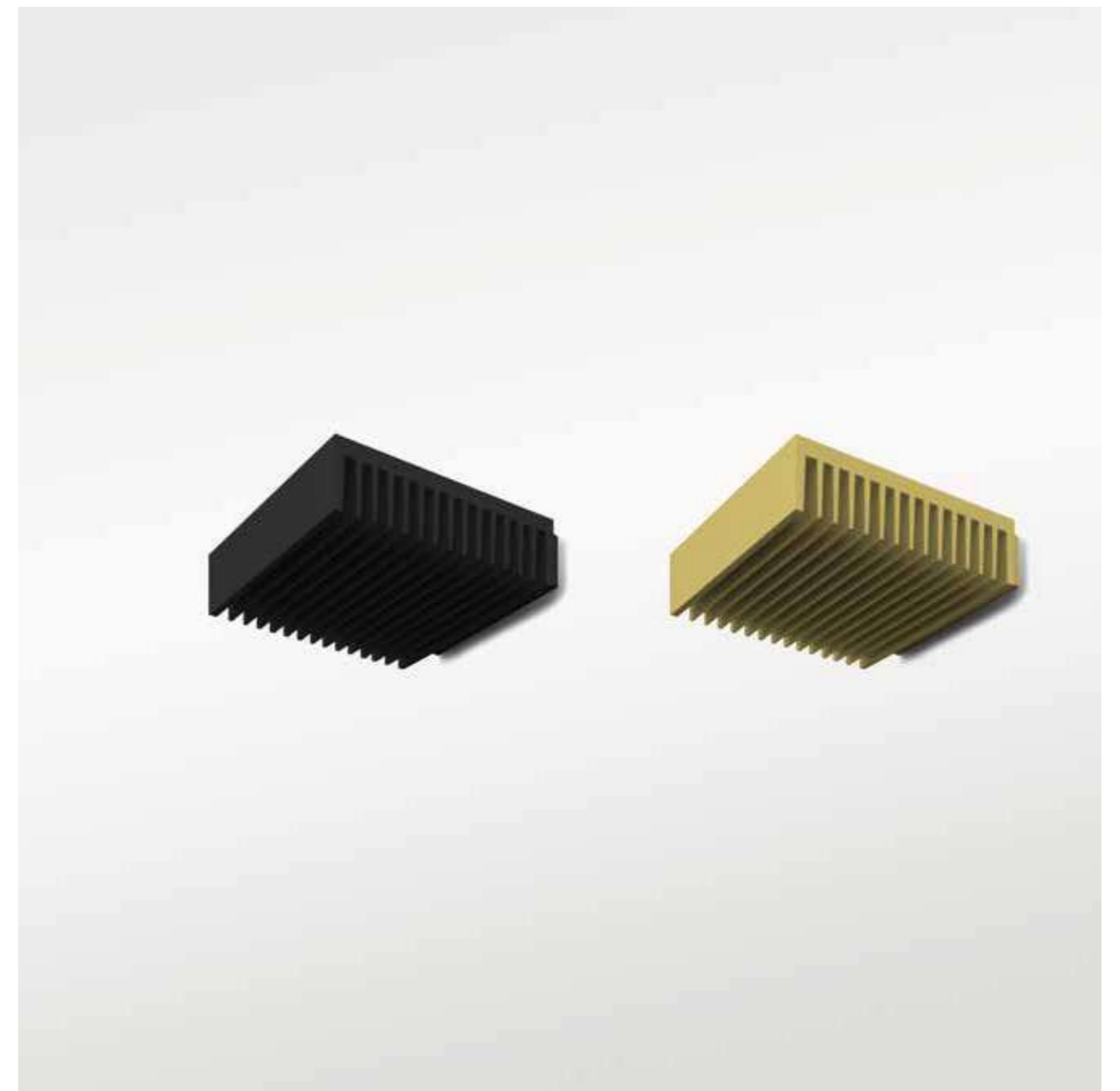

DATI TECNICI
TECHNICAL DATA

	1 cm	25,5 cm
Nominal LED Flux:	15600 lm/m	3900 lm
Flux Tot:	12480 lm/m	3120 lm
Output:	130 lm/W	130 lm/W
CCT:	3000 K	3000 K
CRI:	>90	>90
Power:	120.0W/m	6.0W x 5
Weight:	1.20 Kg/m	0.3 Kg

Profilo/Profile: Alluminio/aluminum

Cover: Opale/Opal

 ALIMENTATORE ON/OFF INCLUSO
 DIMMABLE ON/OFF INCLUDED

FINITURA STRUTTURA FINISHES	1 cm		25,5 cm	
	DRIVER NON INCLUSO/ DIMMABLE NOT INCLUDED		DRIVER NON INCLUSO/ DIMMABLE NOT INCLUDED	
	CODICE 2700K CODE 2700K	CODICE 3000K CODE 3000K	CODICE 2700K CODE 2700K	CODICE 3000K CODE 3000K
ARGILLA CLAY	178001F001	178101F001	178001F025	178101F025
BIANCO INTONACO/WHITE	178003F001	178103F001	178003F025	178103F025
NERO CARAVAGGIO BLACK	178004F001	178104F001	178004F025	178104F025
MOKA MOCHA	178005F001	178105F001	178005F025	178105F025
ORO CALIFORNIA/GOLD	178009F001	178109F001	178009F025	178109F025
ARGENTO COMETA/SILVER COMET	178012F001	178112F001	178012F025	178112F025
TITANIO/TITANIUM	178014F001	178114F001	178014F025	178114F025
BRONZO RIACI/RIACI BRONZE	178015F001	178115F001	178015F025	178115F025
VERDE COSTA/GREEN COAST	178016F001	178116F001	178016F025	178116F025

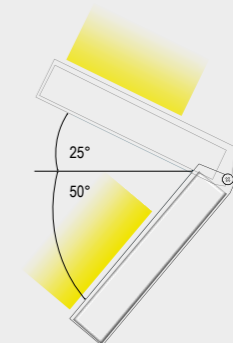
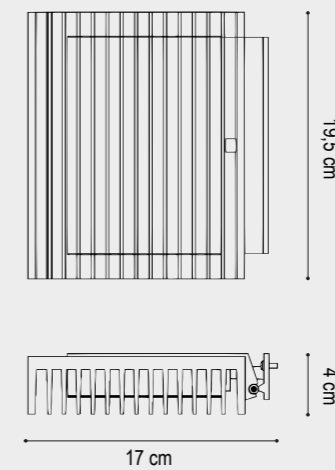

“la lampada minimale”

FLOYD si distingue per il suo design minimale e moderno. Equipaggiato con led ad alta resa cromatica, emette una luce piacevole e confortevole, abbinato alle diverse finiture proposte dalla design luce, diventa anche un complemento d'arredo. Può essere proposto in ambienti domestici, di relax, o di lavoro.

FLOYD stands out for its minimal and modern design. Equipped with high color rendering LEDs, it emits a pleasant and comfortable light, combined with the different finishes proposed by the light design, it also becomes a piece of furniture. It can be proposed in domestic, relaxing, or work environments.



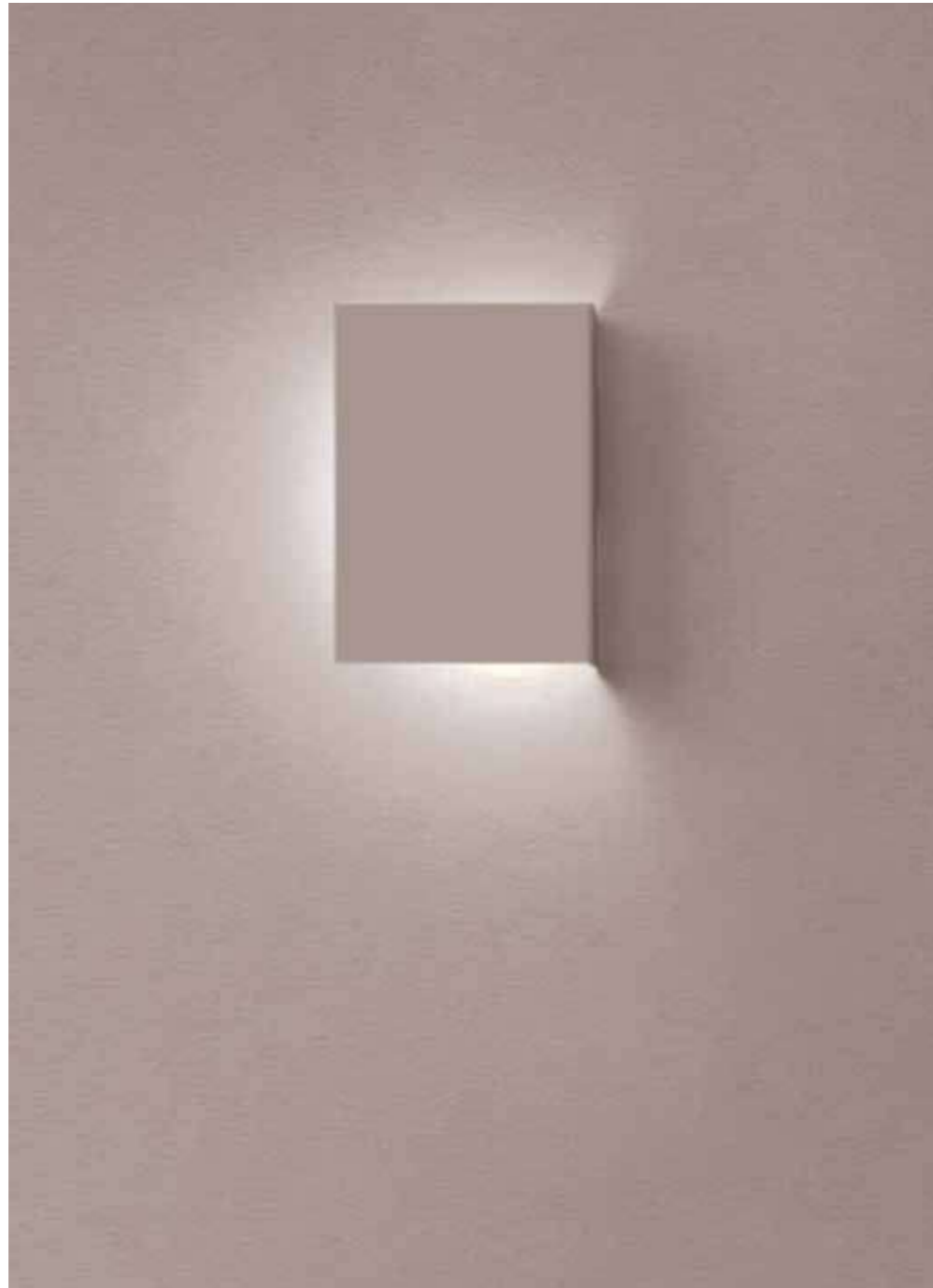

DATI TECNICI TECHNICAL DATA	FINITURA STRUTTURA FINISHES	15 cm		
		CODICE 2700K CODE 2700K	CODICE 3000K CODE 3000K	CODICE 4000K CODE 4000K
Nominal LED Flux: 1300 lm Flux Tot: 1300 lm Output: 130 lm/W CCT: 3000 K CRI: >90 Power Tot: 10.0W Hight: 21 cm Weight: 1.00 Kg Profile: alluminio/aluminum Cover: opale/opal	ARGILLA CLAY	168001F015	168101F015	168201F015
	BIANCO INTONACO/WHITE	168003F015	168103F015	168203F015
	NERO CARAVAGGIO/BLACK	168004F015	168104F015	168204F015
	MOKA MOCHA	168005F015	168105F015	168205F015
	CROMO/CHROME	168008F015	168108F015	168208F015
	ORO CALIFORNIA/GOLD	168009F015	168109F015	168209F015
	ARGENTO COMETA/SILVER COMET	168012F015	168112F015	168212F015
	TITANIO/TITANIUM	168014F015	168114F015	168214F015
	BRONZO RIACI/RIACI BRONZE	168015F015	168115F015	168215F015
	VERDE COSTA/GREEN COAST	168016F015	168116F015	168216F015

ALIMENTATORE ON/OFF INCLUSO
DIMMABLE ON/OFF INCLUDED

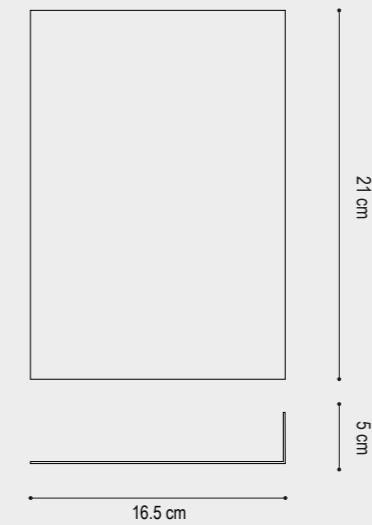

“la lampada orientabile come una vela”

GENOA una lampada minimale e al contempo studiata per portare la luce ovunque, a terra sui tavoli sulle pareti. Disegnata con base e stelo a sezione rettangolare, congiunti da un elegante cavo in acciaio, rendendo la lampada simile alla “vela Genoa” a cui ci siamo ispirati.

GENOA a minimal lamp and at the same time designed to bring light everywhere, on the floor on the tables on the walls. Designed with a rectangular base and stem, joined by an elegant steel cable, this has a dual function, both on-off and aesthetic, making the lamp similar to the “Genoa sail” we were inspired by.





DATI TECNICI
TECHNICAL DATA

12W/m - CRI>97	
Nominal LED Flux:	1900 lm/m
Flux Tot:	1520 lm/m
Output:	158 lm/W
CCT:	3000 K
CRI:	>90
Power:	12.0W/m
Weight:	1.20 Kg/m
Profilo/Profile: Alluminio/aluminum Cover: Opale/Opal	

POWER BOX A PARETE ON/OFF INCLUSO / INCLUDED

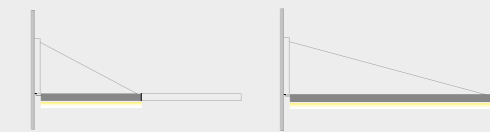
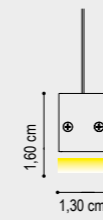

DA 50 cm A 130 cm

DA 131 cm A 300 cm

FINITURA STRUTTURA
FINISHES

- ARGILLA CLAY
- BIANCO INTONACO/WHITE
- NERO CARAVAGGIO BLACK
- MOKA MOCHA
- ORO CALIFORNIA/GOLD
- TITANIO/TITANIUM
- BRONZO RIACI/RIACI BRONZE

COLORE CAVO
WIRE COLOR

- ACCIAIO
STEEL

CODICE
CODE

- 095501M001
- 095503M001
- 095504M001
- 095505M001
- 095509M001
- 095514M001
- 095515M001

CODICE
CODE

- 095501P001
- 095503P001
- 095504P001
- 095505P001
- 095509P001
- 095514P001
- 095515P001

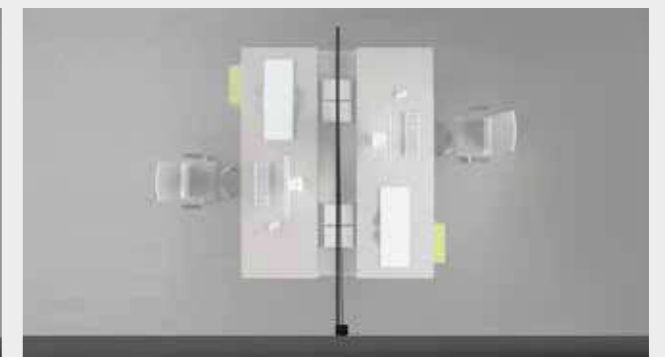
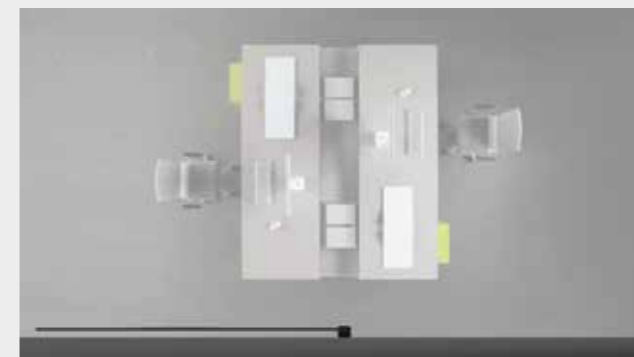

“la lampada minimale”

RIALTO, dal nome si capisce da dove parte lo studio e l'ispirazione. I ponti ... da sempre meraviglie dell'ingegneria, che nel corso dei secoli sono stati pensati per collegare luoghi, attraversare fiumi, agevolare passaggi e unire popoli. La luce per noi ha la stessa funzione, unisce, favorisce la presenza delle persone nei luoghi e ne accentua il comfort. Disegnato con base rettangolare e stelo a sezione circolare regolabile sull'asse orizzontale, congiunta alla parete da un elegante cavo in acciaio la cui duplice funzione è quella estetica e di sostegno. Rialto viene equipaggiata con tecnologia a led ad emissione diretta/indiretta e accensione Touch.

RIALTO, from the name you can understand where the study and inspiration starts from. Bridges ... always wonders of engineering, which over the centuries have been designed to connect places, cross rivers, facilitate passageways and unite peoples. For us, light has the same function, it unites, promotes the presence of people in places and accentuates their comfort. Designed with a rectangular base and a circular section stem adjustable on the horizontal axis, joined to the wall by an elegant steel cable whose dual function is that of aesthetics and support. Rialto is equipped with direct / indirect emission LED technology and Touch ignition.



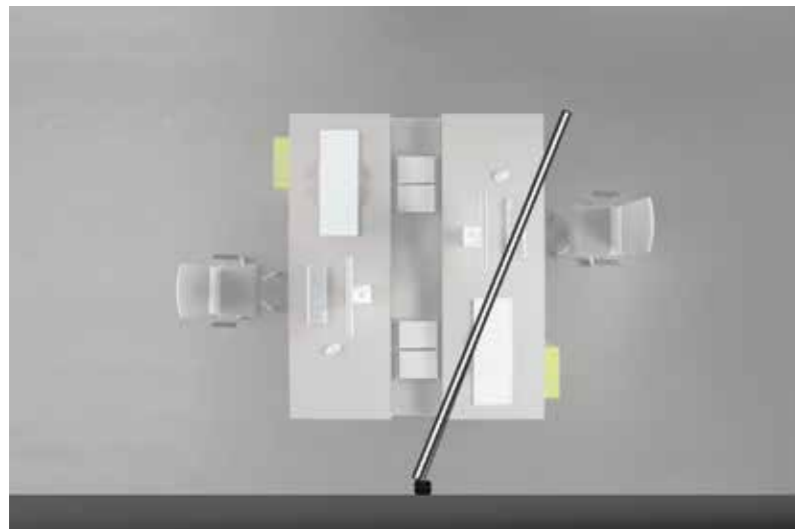
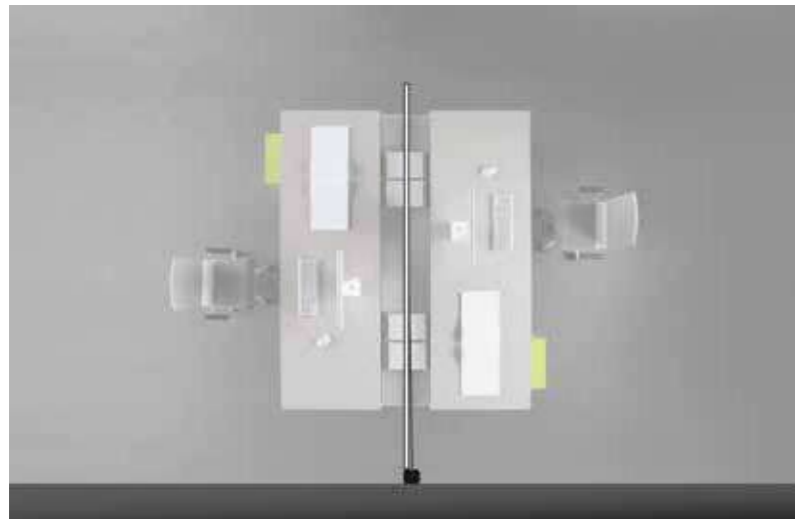
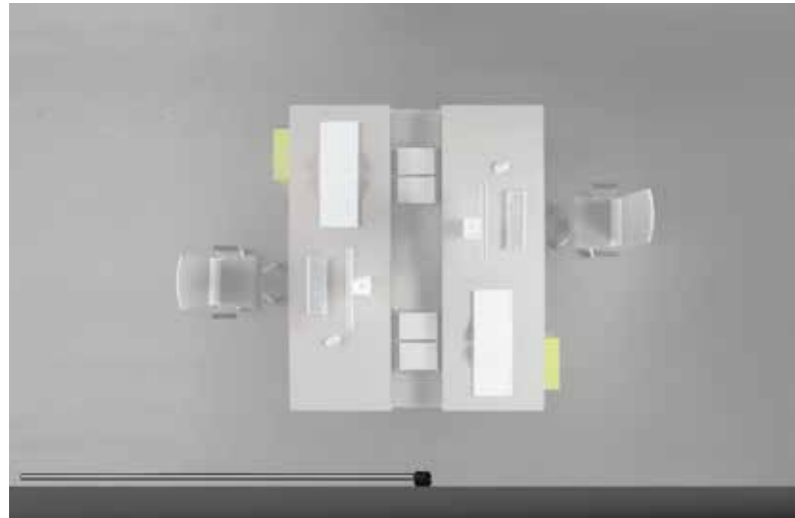

DATI TECNICI
TECHNICAL DATA

	60W/m
Nominal LED Flux:	↑ 3150 lm/m - 3150 lm/m ↓
Flux Tot:	↑ 2520 lm/m - 2520 lm/m ↓
Output:	110 lm/W
CCT:	3000 K
CRI:	>90
Power:	↑ 30.0W/m - 30.0W/m ↓
Power Tot:	60.0W/m
Weight:	4.10 Kg

Profilo/Profile: Alluminio/aluminum Cover: Opale-satinata/Opal-satin
POWER BOX A PARETE ON/OFF INCLUSO / INCLUDED

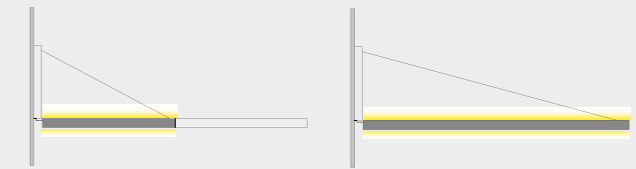
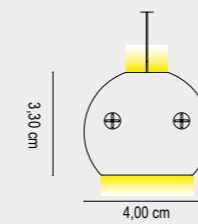

DA 50 cm A 130 cm DA 131 cm A 300 cm

FINITURA STRUTTURA
FINISHES

- ARGILLA CLAY
- BIANCO INTONACO/WHITE
- NERO CARAVAGGIO BLACK
- MOKA MOCHA
- ORO CALIFORNIA/GOLD
- TITANIO/TITANIUM
- BRONZO RIACI/RIACI BRONZE

COLORE CAVO
WIRE COLOR

ACCIAIO
STEEL

CODICE
CODE

- 208101M001
- 208103M001
- 208104M001
- 208105M001
- 208109M001
- 208114M001
- 208115M001

CODICE
CODE

- 208101P001
- 208103P001
- 208104P001
- 208105P001
- 208109P001
- 208114P001
- 208115P001

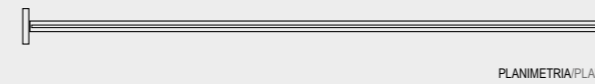

PLANIMETRIA/PLAN

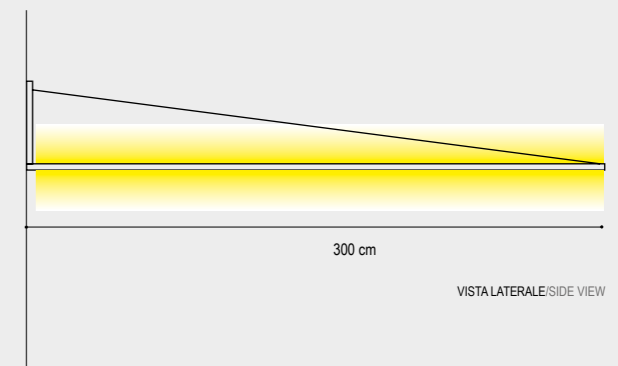

300 cm

VISTA LATERALE/SIDE VIEW



“eleganza, comfort e flessibilità”

Da secoli gli uomini hanno imparato a trarre vantaggi dagli elementi naturali. Questa lampada prende il nome da un'innovazione che ci ha permesso di spostarsi più velocemente e scoprire incantevoli scenari, grazie ad un altro elemento molto importante la Luce, da sempre indispensabile per la nostra vita. La sua silhouette rettangolare minimale, il meccanismo di orientabilità del braccio sul piano orizzontale, abbinato ad un gruppo ottico estremamente arretrato, che ne aumenta il comfort visivo riducendone l'abbagliamento. L'insieme di queste innovazioni danno a questa lampada eleganza, comfort e flessibilità.

For centuries men have learned to take advantage of natural elements. This lamp takes its name from an innovation that has allowed us to move faster and discover enchanting scenarios, thanks to another very important element, the Light, which has always been indispensable for our life. Its minimal rectangular silhouette, the swivel mechanism of the arm on the horizontal plane, combined with an extremely rearward optical unit, which increases its visual comfort by reducing glare. The combination of these innovations gives this lamp elegance, comfort and flexibility we were inspired by.



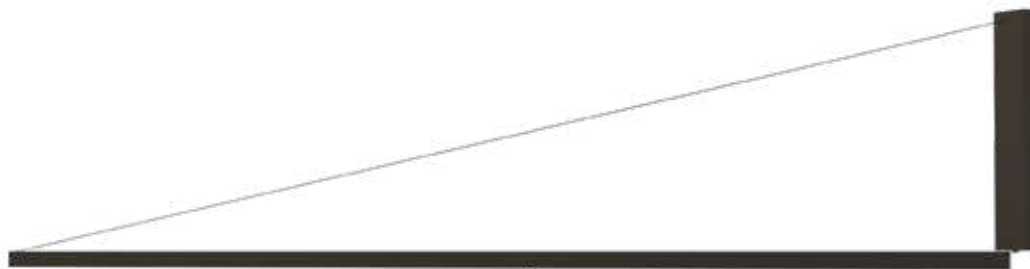
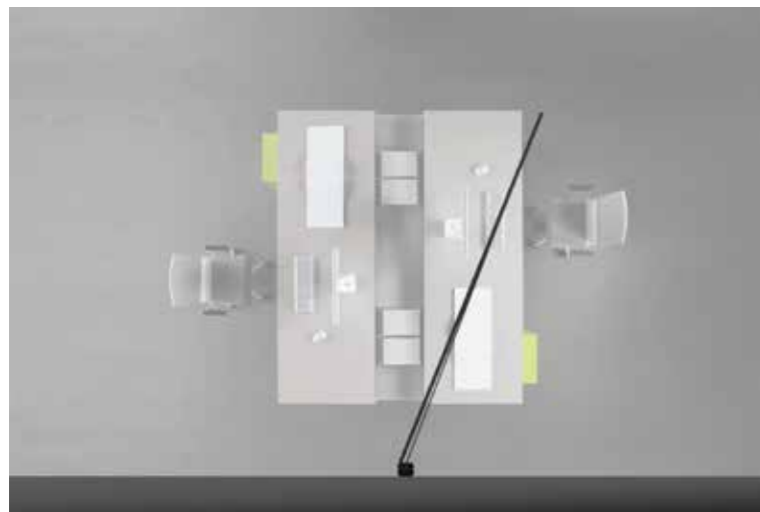
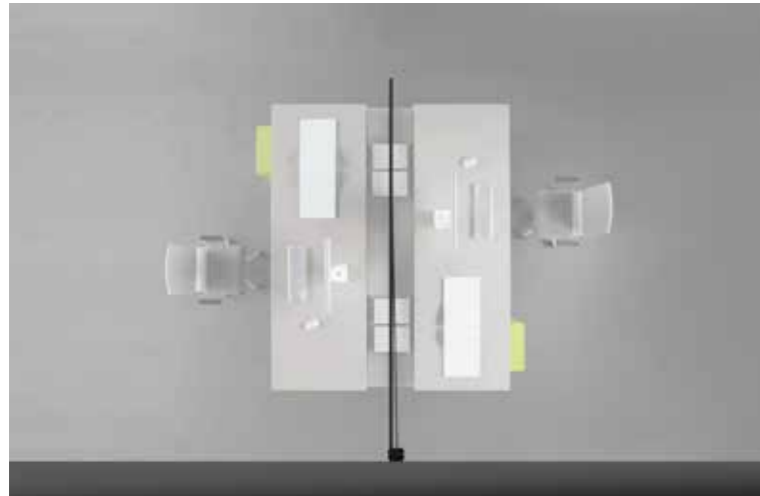

DATI TECNICI
TECHNICAL DATA

12W/m - CRI>97	
Nominal LED Flux:	1610 lm/m
Flux Tot:	1290 lm/m
Output:	138 lm/W
CCT:	3000 K
CRI:	>97 - R9>90
Power:	12.0W/m
Weight:	1.40 Kg/m

Profilo/Profile: Alluminio/aluminum Cover: Opale/Opal

POWER BOX A PARETE ON/OFF INCLUSO / INCLUDED

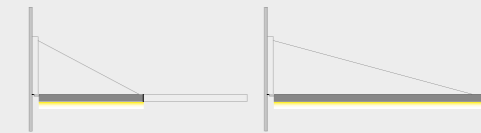
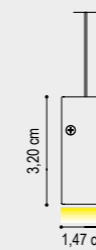

DA 50 cm A 130 cm DA 131 cm A 300 cm

FINITURA STRUTTURA
FINISHES

- ARGILLA CLAY
- BIANCO INTONACO/WHITE
- NERO CARAVAGGIO/BLACK
- MOKA MOCHA
- CROMO/CHROME
- ORO CALIFORNIA/GOLD
- ARAMEN COPPER
- GRIGIO AVIO/ GREY AVIO
- ARGENTO COMETA/SILVER COMET
- OTTONE VENEZIANO/ VENETIAN BRASS
- TITANIO/TITANIUM
- BRONZO RIACI/RIACI/ BRONZE
- VERDE COSTA/GREEN COAST
- TERRA SENESE SENESE EARTH

COLORE CAVO
WIRE COLOR

ACCIAO
STEEL

CODICE
CODE

- 159701M001
- 159703M001
- 159704M001
- 159705M001
- 159708M001
- 159709M001
- 159710M001
- 159711M001
- 159712M001
- 159713M001
- 159714M001
- 159715M001
- 159716M001
- 159717M001

CODICE
CODE

- 159701P001
- 159703P001
- 159704P001
- 159705P001
- 159708P001
- 159709P001
- 159710P001
- 159711P001
- 159712P001
- 159713P001
- 159714P001
- 159715P001
- 159716P001
- 159717P001

“nuove forme geometriche”

OLIMPIA inaugura la nuova sfida di Design Luce: illuminare gli spazi architettonici con nuove forme geometriche. Per questa lampada abbiamo pensato al cerchio, da sempre forma elementare ed armonica. OLIMPIA racchiude in se tutta l' eleganza e la leggerezza di una lampada LED dagli elevati contenuti tecnici ed illuminotecnici. Grazie allo studio del posizionamento dei gruppi ottici, che garantiscono la doppia emissione, alla regolazione luminosa, oltre ai diametri e finiture customizzabili.

OLIMPIA inaugurates the new challenge of Design Luce: lighting architectural spaces with new geometric shapes. For this lamp we have thought about the circle, elementary and harmonic. OLIMPIA embodies all the elegance and lightness of a LED lamp with high technical and engineering contents as the positioning of the optical groups, which guarantee a double emission, the luminous regulation and the customizable diameter and finishes.



olimpia

customizzazione

customization

olimpia

designer

luigii cerbone

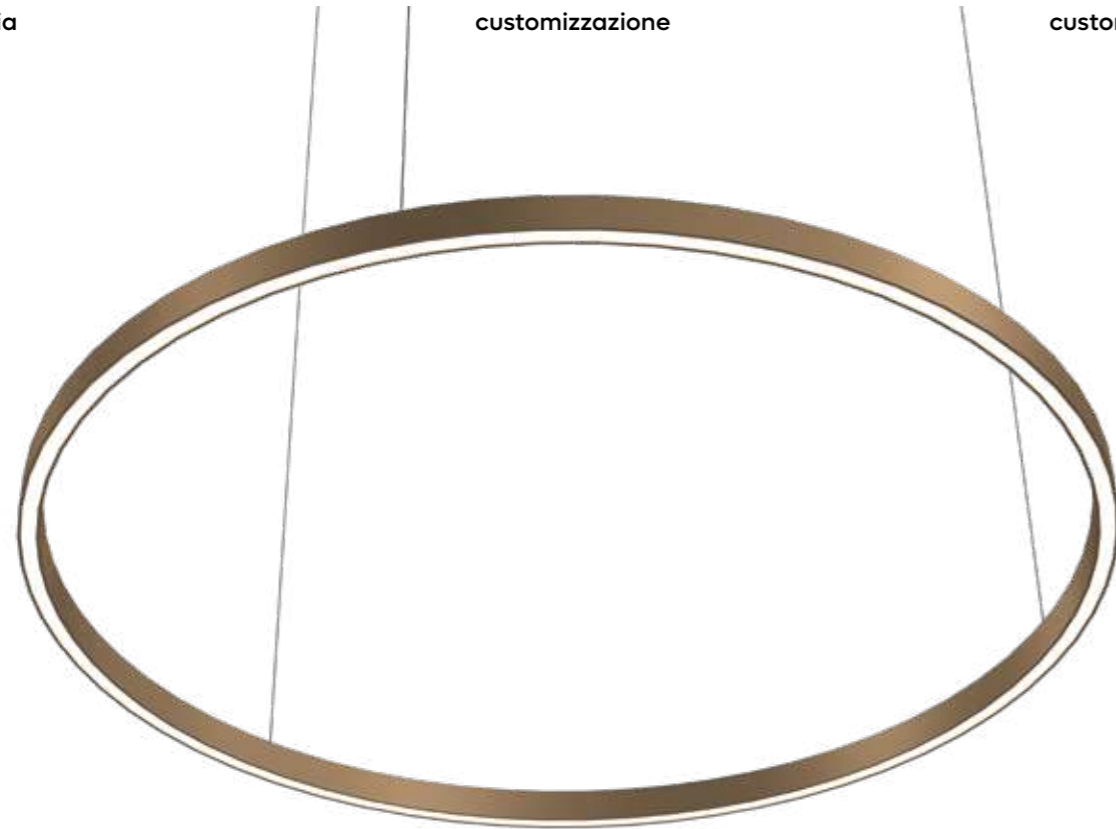

Dmin = 45,00 cm / Dmax = 180,00 cm

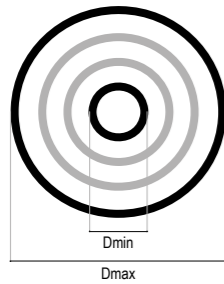

Il prodotto verrà fornito come unica circonferenza
The product will be supplied as a single circumference

D > 180,00 cm

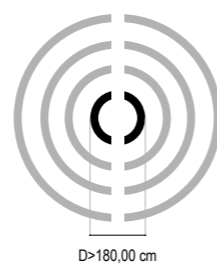

Il prodotto verrà fornito in più archi di circonferenza da giuntare
The product will be supplied in several circumference arcs to be joined

Gli schemi riportati nelle presenti schede sono puramente indicativi.

Ogni richiesta di customizzazione va sottoposta esclusivamente alla Design Luce srlu che ne valuterà la fattibilità tecnica.

The diagrams shown in these sheets are purely indicative.

Any request for customization must be submitted exclusively to the Design Luce srlu which will evaluate its technical feasibility.

BOX COPRIMORSETTI / TERMINAL BOX

DATI TECNICI TECHNICAL DATA	DIMENSIONI (ln x lg x h) DIMENSIONS	FINITURA FINISHES	CODICE CODE
Tensione/Voltage: 24V - CC SELV / 220-240v - 50-60 Hz Power Factor > 0.9 at > 50% load DC Operation 176-264v DC Ambient Temperature: -15°C to 60°C		<div style="border: 1px solid black; padding: 2px; display: inline-block;">BIANCO/WHITE</div> <div style="border: 1px solid black; padding: 2px; display: inline-block; background-color: black; color: white;">NERO/BLACK</div>	10403 10404

N.B. DA ORDINARE NELLA VERSIONE CON DRIVER REMOTO
TO BE ORDERED IN THE VERSION WITH REMOTE DRIVER



olimpia

versione solo cavi alimentazione

scheda tecnica

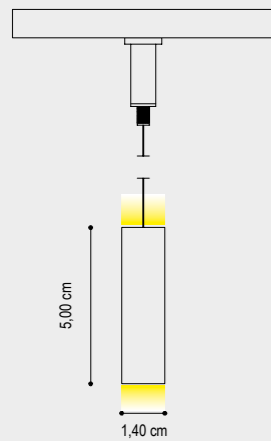

SEZIONE PROFILO/PROFILE SECTION

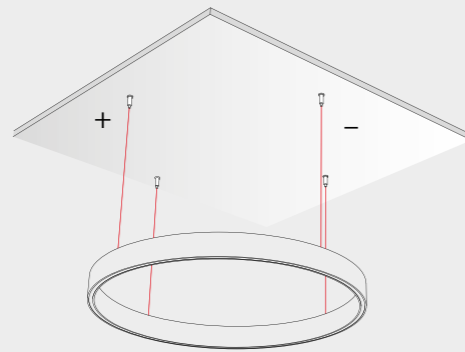

OLIMPIA CON DRIVER REMOTO
OLIMPIA WITH REMOTE DRIVER

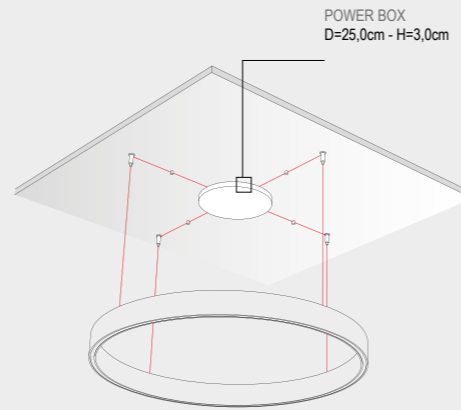

OLIMPIA CON BOX
OLIMPIA WITH POWER SUPPLY BOX

ATTENZIONE/PLEASE NOTE: SU RICHIESTA DIAMETRO CUSTOM / CUSTOM DIAMETER ON REQUEST

DATI TECNICI
TECHNICAL DATA

	D 45 cm	D 55 cm	D 75 cm
Nominal LED Flux:	↑2686 lm - 5372 lm ↓	↑3318 lm - 6636 lm ↓	↑4424 lm - 9006 lm ↓
Flux Tot:	↑2148 lm - 4297 lm ↓	↑2654 lm - 5308 lm ↓	↑3539 lm - 7205 lm ↓
Output:	158 lm/W	158 lm/W	158 lm/W
CCT:	3000 K	3000 K	3000 K
CRI:	>90	>90	>90
Power:	↑17.0W - 34.0W ↓	↑21.0W - 42.0W ↓	↑28.0W - 57.0W ↓
Power Tot:	51.0W	63.0W	85.0W
Weight:	1.42 Kg	1.90 Kg	2.50 Kg
Profilo/Profile:	Alluminio/aluminum		Cover: Satinata/satin



MODELLO DI INSTALLAZIONE
INSTALLATION MODEL



N°4 CAVI DI ALIMENTAZIONE/SOSPENSIONE
N°4 POWER SUPPLY/SUSPENSION CABLES

DRIVER 24V ON/OFF INCLUSO
PER INSTALLAZIONE IN REMOTO
DRIVER 24V ON/OFF INCLUDED
FOR REMOTE INSTALLATION

CAVO ALIMENTAZIONE/SOSPENSIONE: 200 cm
SUSPENSION ALIMENTATION CABLE: 200 cm

olimpia

cavi in acciaio + cavo alimentazione

scheda tecnica

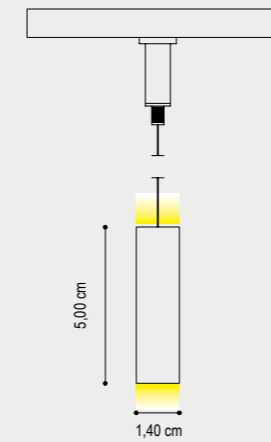

SEZIONE PROFILO/PROFILE SECTION

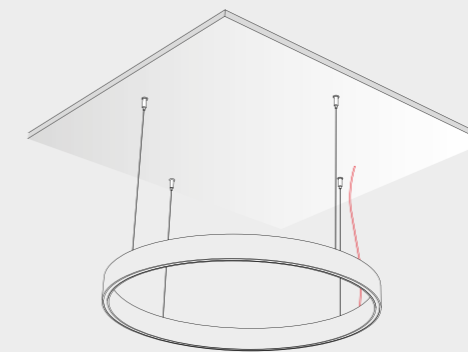

OLIMPIA CON DRIVER REMOTO
OLIMPIA WITH REMOTE DRIVER

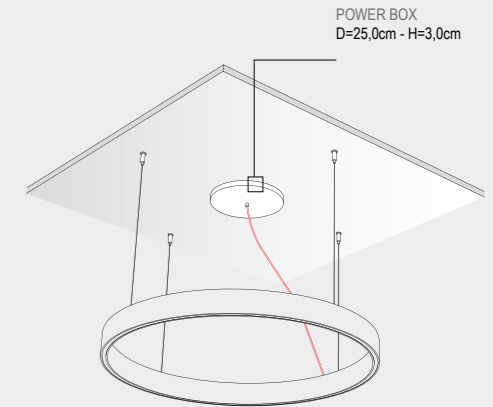

OLIMPIA WITH POWER SUPPLY BOX

ATTENZIONE/PLEASE NOTE: SU RICHIESTA DIAMETRO CUSTOM / CUSTOM DIAMETER ON REQUEST

DATI TECNICI
TECHNICAL DATA



MODELLO DI INSTALLAZIONE
INSTALLATION MODEL



N°4 CAVI SOSPENSIONE + ALIMENTAZIONE
N°4 SUSPENSION + POWER CABLES

DRIVER 24V ON/OFF INCLUSO
PER INSTALLAZIONE IN REMOTO
DRIVER 24V ON/OFF INCLUDED
FOR REMOTE INSTALLATION

CAVO ALIMENTAZIONE TRASPARENTE: 200 cm
TRANSPARENT ALIMENTATION CABLE: 200 cm
CAVI SOSPENSIONE IN ACCIAIO: 200 cm
SUSPENSION CABLES IN STEEL: 200 cm

	D 45 cm	D 55 cm	D 75 cm
Nominal LED Flux:	↑2686 lm - 5372 lm ↓	↑3318 lm - 6636 lm ↓	↑4424 lm - 9006 lm ↓
Flux Tot:	↑2148 lm - 4297 lm ↓	↑2654 lm - 5308 lm ↓	↑3539 lm - 7205 lm ↓
Output:	158 lm/W	158 lm/W	158 lm/W
CCT:	3000 K	3000 K	3000 K
CRI:	>90	>90	>90
Power:	↑17.0W - 34.0W ↓	↑21.0W - 42.0W ↓	↑28.0W - 57.0W ↓
Power Tot:	51.0W	63.0W	85.0W
Weight:	1.42 Kg	1.90 Kg	2.50 Kg
Profilo/Profile:	Alluminio/aluminum		Cover: Satinata/satin

FINITURA STRUTTURA
FINISHES

BIANCO INTONACO/WHITE
NERO CARAVAGGIO/BLACK
CROMO/CHROME
ORO CALIFORNIA/GOLD
ARAMEN COPPER
GRIGIO AVIO/ GREY AVIO
ARGENTO COMETA/SILVER COMET
TITANIO/TITANIUM
BRONZO RIACI/RIACI BRONZE
VERDE COSTA/GREEN COAST

COLORE CAVO
WIRE COLOR

TRASPARENTE
TRANSPARENT

	D 45 cm	D 55 cm	D 75 cm
CODICE CODE	4055031045	4055031055	4055031075
4055041045	4055041055	4055041075	
4055081045	4055081055	4055081075	
4055091045	4055091055	4055091075	
4055101045	4055101055	4055101075	
4055111045	4055111055	4055111075	
4055121045	4055121055	4055121075	
4055141045	4055141055	4055141075	
4055151045	4055151055	4055151075	
4055161045	4055161055	4055161075	

FINITURA STRUTTURA
FINISHES

BIANCO INTONACO/WHITE
NERO CARAVAGGIO/BLACK
CROMO/CHROME
ORO CALIFORNIA/GOLD
ARAMEN COPPER
GRIGIO AVIO/ GREY AVIO
ARGENTO COMETA/SILVER COMET
TITANIO/TITANIUM
BRONZO RIACI/RIACI BRONZE
VERDE COSTA/GREEN COAST

COLORE CAVO
WIRE COLOR

ACCIAIO
STEEL

TRASPARENTE
TRANSPARENT

	D 45 cm	D 55 cm	D 75 cm
CODICE CODE	4055032045	4055032055	4055032075
4055042045	4055042055	4055042075	
4055082045	4055082055	4055082075	
4055092045	4055092055	4055092075	
4055102045	4055102055	4055102075	
4055112045	4055112055	4055112075	
4055122045	4055122055	4055122075	
4055142045	4055142055	4055142075	
4055152045	4055152055	4055152075	
4055162045	4055162055	4055162075	

BOX DI ALIMENTAZIONE CON FORI RADIALI /
POWER SUPPLY BOX WITH RADIAL HOLES

		60W	96W	120W (2x60W)	192W (2x96W)
FINITURA STRUTTURA FINISHES	TIPOLOGIA TYPE	CODICE CODE	CODICE CODE	CODICE CODE	CODICE CODE
BIANCO INTONACO/WHITE	ON/OFF	T03060	T03096	T03120	T03192
	DALI	D03060	D03096	D03120	D03192

N.B.: VERSIONE 120W E 192W CON-
FIGURATI PER DOPPIA ACCENSIONE
/ PLEASE NOTE: 120W AND 192W
VERSION CONFIGURED FOR DOUBLE
IGNITION

BOX DI ALIMENTAZIONE CON FORO CENTRALE /
POWER SUPPLY BOX WITH CENTRAL HOLE

	BIANCO INTONACO/WHITE				
	60W	96W	120W (2x60W)	156W	192W (2x96W)
FINITURA STRUTTURA / FINISHES	TIPOLOGIA TYPE	CODICE CODE	CODICE CODE	CODICE CODE	CODICE CODE
	ON/OFF	F03060	F03096	F03120	F03156
	DALI	S03060	S03096	S03120	S03156

N.B.: VERSIONE 120W E 192W CONFIGURATI
PER DOPPIA ACCENSIONE / PLEASE NOTE:
120W AND 192W VERSION CONFIGURED FOR
DOUBLE IGNITION



“nuove forme geometriche”

OLIMPIA IRID inaugura la nuova sfida di Design Luce: illuminare gli spazi architettonici con nuove forme geometriche. Per questa lampada abbiamo pensato al cerchio, da sempre forma elementare ed armonica. OLIMPIA racchiude in se tutta l'eleganza e la leggerezza di una lampada LED dagli elevati contenuti tecnici ed illuminotecnici. Grazie allo studio del posizionamento dei gruppi ottici, che garantiscono la doppia emissione, alla regolazione luminosa, oltre ai diametri e finiture customizzabili.

OLIMPIA IRID inaugurates the new challenge of Design Luce: lighting architectural spaces with new geometric shapes. For this lamp we have thought about the circle, elementary and harmonic. OLIMPIA embodies all the elegance and lightness of a LED lamp with high technical and engineering contents as the positioning of the optical groups, which guarantee a double emission, the luminous regulation and the customizable diameter and finishes.



olimpia irid

customizzazione

customization



Dmin = 45,00 cm / Dmax = 180,00 cm

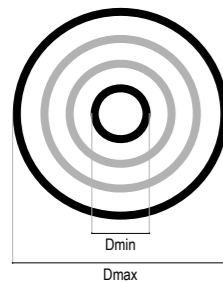

Il prodotto verrà fornito come unica circonferenza
The product will be supplied as a single circumference

D > 180,00 cm



Il prodotto verrà fornito in più archi di circonferenza da giungere
The product will be supplied in several circumference arcs to be joined

Gli schemi riportati nelle presenti schede sono puramente indicativi.
Ogni richiesta di customizzazione va sottoposta esclusivamente alla Design Luce srlu che ne valuterà la fattibilità tecnica.

The diagrams shown in these sheets are purely indicative.
Any request for customization must be submitted exclusively to the Design Luce srlu which will evaluate its technical feasibility.

olimpia irid

cavi in acciaio + cavo alimentazione

scheda tecnica

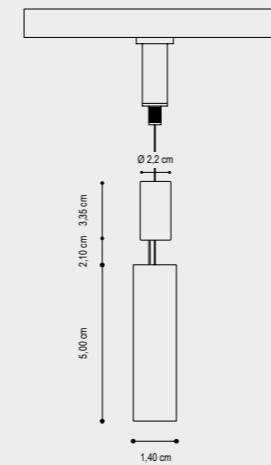

SEZIONE PROFILO/PROFILE SECTION

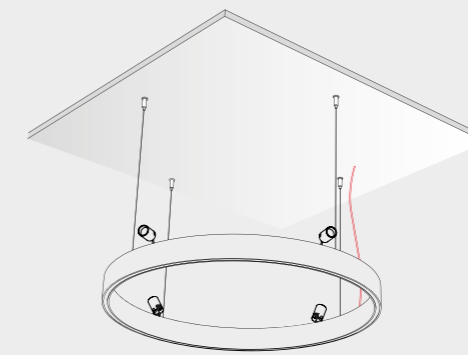

OLIMPIA CON DRIVER REMOTO
OLIMPIA WITH REMOTE DRIVER

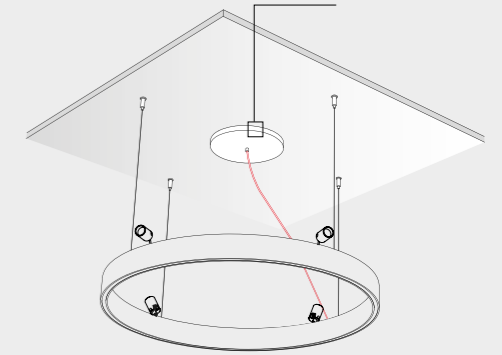

OLIMPIA CON BOX
OLIMPIA WITH POWER SUPPLY BOX

POWER BOX
D=25,0cm - H=3,0cm

ATTENZIONE/PLEASE NOTE: SU RICHIESTA DIAMETRO CUSTOM / CUSTOM DIAMETER ON REQUEST



MODELLO DI INSTALLAZIONE
INSTALLATION MODEL

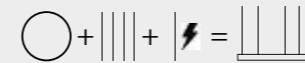

N°4 CAVI SOSPENSIONE + ALIMENTAZIONE
N° 4 SUSPENSION + POWER CABLES

DRIVER 24V ON/OFF INCLUSO
PER INSTALLAZIONE IN REMOTO
DRIVER 24V ON/OFF INCLUDED
FOR REMOTE INSTALLATION

CAVO ALIMENTAZIONE TRASPARENTE: 200 cm
TRANSPARENT ALIMENTATION CABLE: 200 cm
CAVI SOSPENSIONE IN ACCIAIO: 200 cm
SUSPENSION CABLES IN STEEL: 200 cm

DATI TECNICI
TECHNICAL DATA

	D 45 cm	D 55 cm	D 75 cm
Nominal LED Flux:	↑ 3486 lm - 5372 lm ↓	↑ 4118 lm - 7436 lm ↓	↑ 5224 lm - 9806 lm ↓
Flux Tot:	↑ 2948 lm - 5097 lm ↓	↑ 3454 lm - 6108 lm ↓	↑ 4339 lm - 8005 lm ↓
Output:	158 lm/W	158 lm/W	158 lm/W
CCT:	3000 K	3000 K	3000 K
CRI:	>90	>90	>90
Power:	↑ 17.0W - 34.0W ↓	↑ 21.0W - 42.0W ↓	↑ 28.0W - 57.0W ↓
Power Tot:	51.0W	63.0W	94.0W
Power Spot:	4x3W 700 mA	4x3W 700 mA	4x3W 700 mA
Weight:	1.42 Kg	1.90 Kg	2.50 Kg

FINITURA STRUTTURA
FINISHES

- BIANCO INTONACO/WHITE
- NERO CARAVAGGIO BLACK
- CROMO CHROME
- ORO CALIFORNIA/GOLD
- ARAMEN COPPER
- GRIGIO AVIO/GREY AVIO
- ARGENTO COMETA/SILVER COMET
- TITANIO/TITANIUM
- BRONZO RIACI/RIACI BRONZE
- VERDE COSTA/GREEN COAST

COLORE CAVO
WIRE COLOR

- ACCIAIO
STEEL
- TRASPARENTE
TRANSPARENT

D 45 cm D 55 cm D 75 cm

CODICE CODE	CODICE CODE	CODICE CODE
40C8032045	40C8032055	40C8032075
40C8042045	40C8042055	40C8042075
40C8082045	40C8082055	40C8082075
40C8092045	40C8092055	40C8092075
40C8102045	40C8102055	40C8102075
40C8112045	40C8112055	40C8112075
40C8122045	40C8122055	40C8122075
40C8142045	40C8142055	40C8142075
40C8152045	40C8152055	40C8152075
40C8162045	40C8162055	40C8162075

BOX DI ALIMENTAZIONE CON FORO CENTRALE /
POWER SUPPLY BOX WITH CENTRAL HOLE

FINITURA STRUTTURA / FINISHES

BIANCO INTONACO/WHITE

	60W	96W	120W (2x60W)	156W	192W (2x96W)
TIPOLOGIA TYPE	CODICE CODE	CODICE CODE	CODICE CODE	CODICE CODE	CODICE CODE
ON/OFF	F03060	F03096	F03120	F03156	F03192
DALI	S03060	S03096	S03120	S03156	S03192

N.B.: VERSIONE 120W E 192W CONFIGURATI
PER DOPPIA ACCENSIONE / PLEASE NOTE:
120W AND 192W VERSION CONFIGURED FOR
DOUBLE IGNITION



“eleganza e leggerezza”

ALTIS inaugura la nuova sfida di Design Luce: illuminare gli spazi architettonici con nuove forme geometriche. Per questa lampada abbiamo pensato al cerchio, da sempre forma elementare e armonica. ALTIS racchiude in sé tutta l'eleganza e la leggerezza di una lampada LED dagli elevati contenuti tecnici ed illuminotecnici. Grazie allo studio del posizionamento dei gruppi ottici, alla regolazione luminosa oltre a diametri e finiture customizzabili.

ALTIS inaugurates the new challenge of Design Luce: lighting architectural spaces with new geometric shapes. For this lamp we have thought about the circle, elementary and harmonic. ALTIS embodies all the elegance and lightness of a LED lamp with high technical and engineering contents as the positioning of the optical groups, which guarantee a double emission, the luminous regulation and the customizable diameter and finishes.

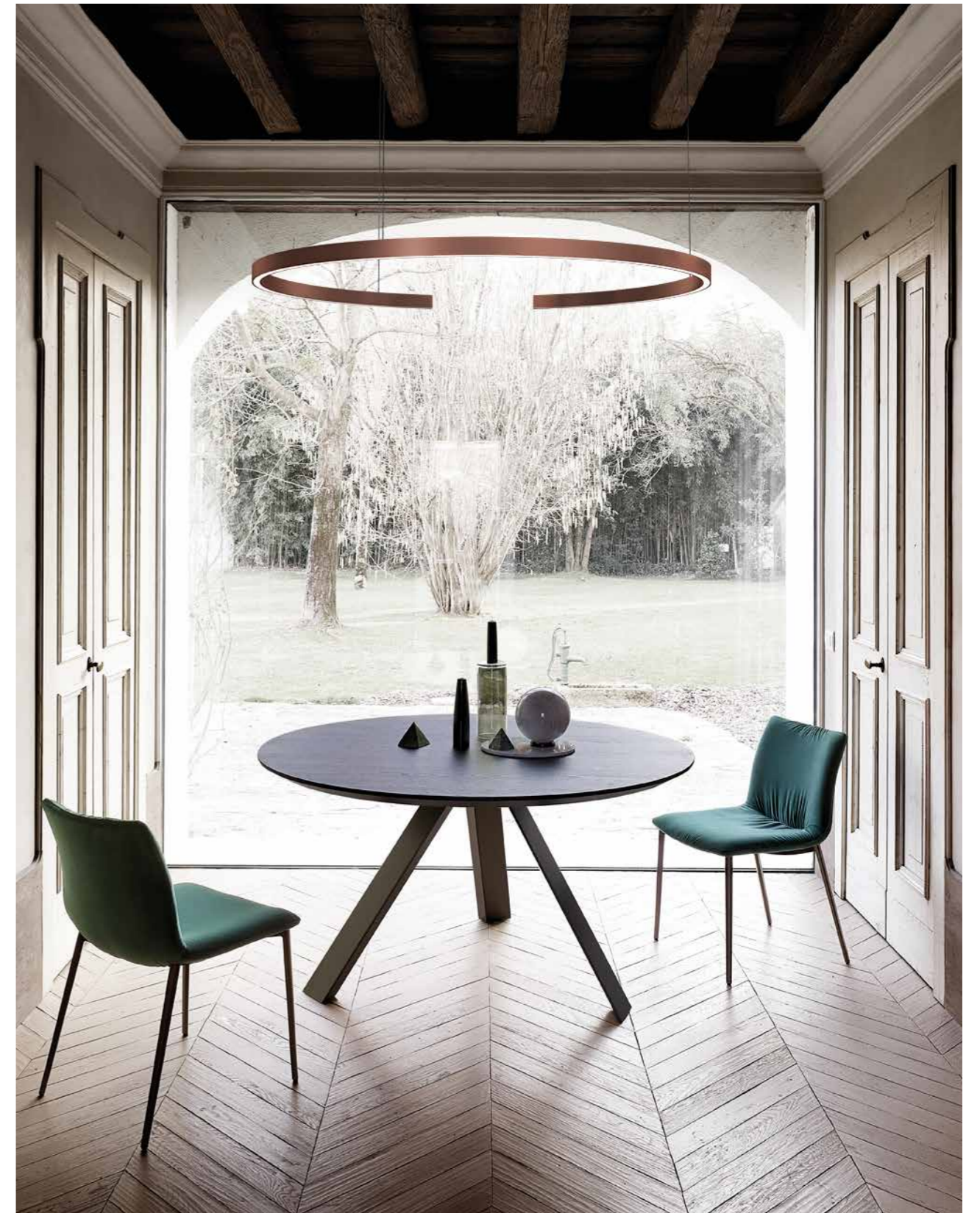

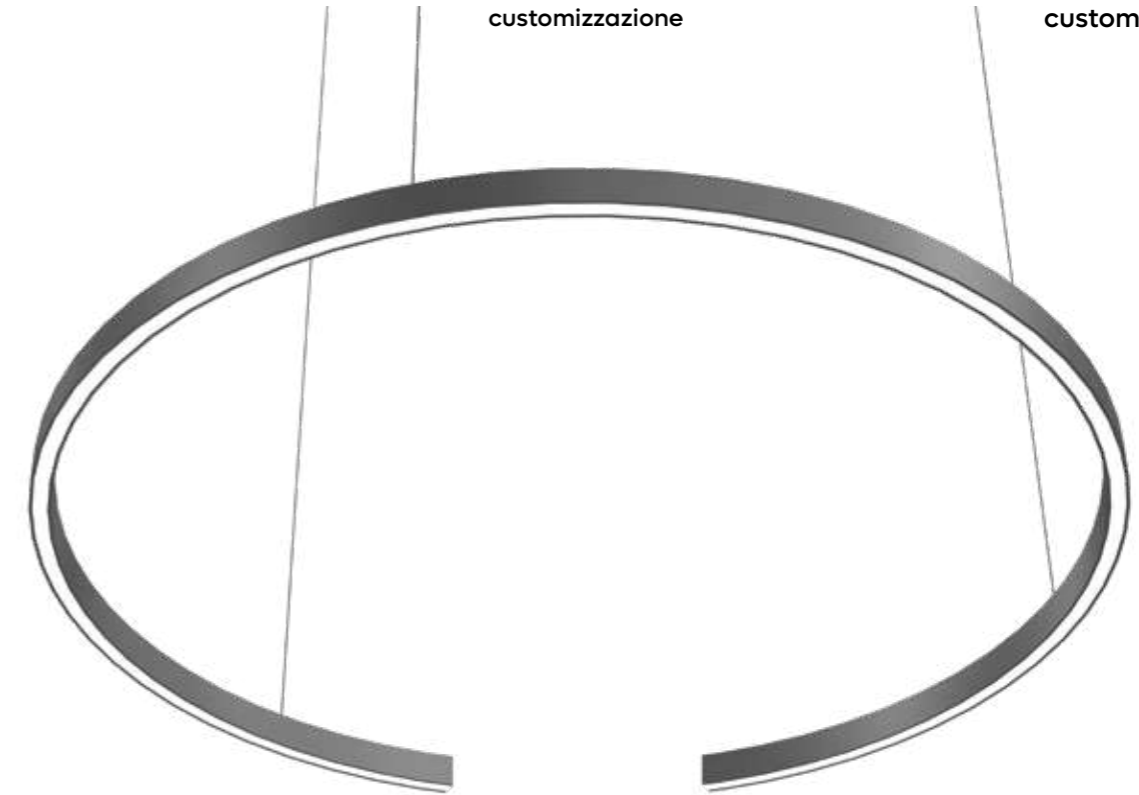

Dmin = 45,00 cm / Dmax = 180,00 cm

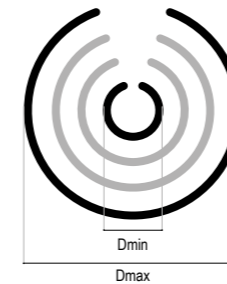

Il prodotto verrà fornito come unica circonferenza
The product will be supplied as a single circumference

D > 180,00 cm



Il prodotto verrà fornito in più archi di circonferenza da giuntare
The product will be supplied in several circumference arcs to be joined

Gli schemi riportati nelle presenti schede sono puramente indicativi.
Ogni richiesta di customizzazione va sottoposta esclusivamente alla Design Luce srlu che ne valuterà la fattibilità tecnica.

The diagrams shown in these sheets are purely indicative.
Any request for customization must be submitted exclusively to the Design Luce srlu which will evaluate its technical feasibility.

BOX COPRIMORSETTI / TERMINAL BOX

DATI TECNICI TECHNICAL DATA	DIMENSIONI (ln x lg x h) DIMENSIONS	FINITURA FINISHES	CODICE CODE
Tensione/Voltage: 24V - CC SELV / 220-240v - 50-60 Hz Power Factor > 0.9 at > 50% load DC Operation 176-264v DC Ambient Temperature: -15°C to 60°C			10403 10404

N.B. DA ORDINARE NELLA VERSIONE CON DRIVER REMOTO
TO BE ORDERED IN THE VERSION WITH REMOTE DRIVER

altis

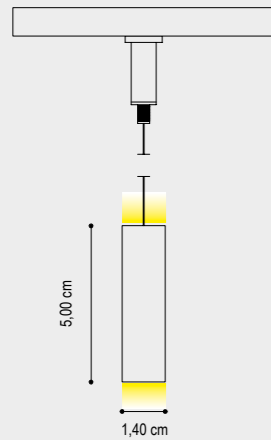

SEZIONE PROFILO/PROFILE SECTION

versione solo cavi alimentazione

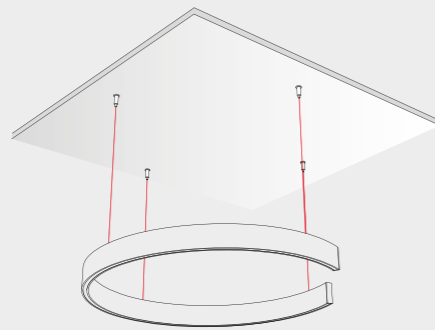

ALTIS CON DRIVER REMOTO
ALTIS WITH REMOTE DRIVER

scheda tecnica

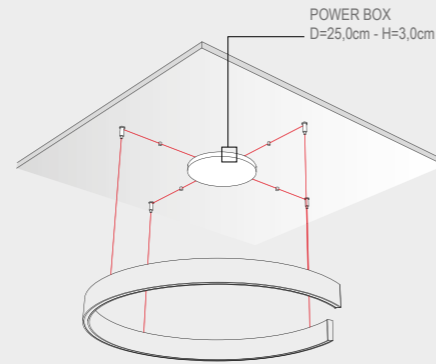

ALTIS CON BOX
ALTIS WITH POWER SUPPLY BOX

ATTENZIONE/PLEASE NOTE: SU RICHIESTA DIAMETRO CUSTOM / CUSTOM DIAMETER ON REQUEST

DATI TECNICI
TECHNICAL DATA

	D 45 cm	D 55 cm	D 75 cm
Nominal LED Flux:	↑2370 lm - 4740 lm ↓	↑3002 lm - 6004 lm ↓	↑4108 lm - 8216 lm ↓
Flux Tot:	↑1896 lm - 3792 lm ↓	↑2402 lm - 4803 lm ↓	↑3286 lm - 6573 lm ↓
Output:	158 lm/W	158 lm/W	158 lm/W
CCT:	3000 K	3000 K	3000 K
CRI:	>90	>90	>90
Power:	↑15.0W - 30.0W ↓	↑19.0W - 38.0W ↓	↑26.0W - 52.0W ↓
Power Tot:	45.0W	57.0W	78.0W
Weight:	1.42 Kg	1.90 Kg	2.50 Kg

Profilo/Profile: Alluminio/aluminum

Cover: Satinata/satin



MODELLO DI INSTALLAZIONE
INSTALLATION MODEL



N°4 CAVI DI ALIMENTAZIONE/SOSPENSIONE
N°4 POWER SUPPLY/SUSPENSION CABLES

DRIVER 24V ON/OFF INCLUSO
PER INSTALLAZIONE IN REMOTO
DRIVER 24V ON/OFF INCLUDED
FOR REMOTE INSTALLATION

CAVO ALIMENTAZIONE/SOSPENSIONE: 200 cm
SUSPENSION ALIMENTATION CABLE: 200 cm

altis

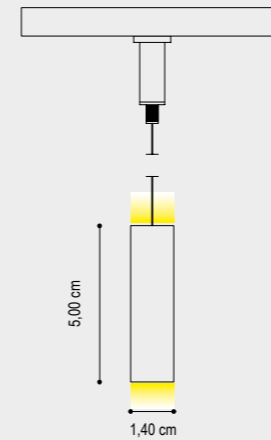

SEZIONE PROFILO/PROFILE SECTION

cavi in acciaio + cavo alimentazione

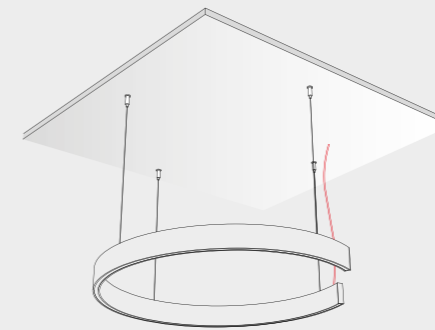

ALTIS CON DRIVER REMOTO
ALTIS WITH REMOTE DRIVER

scheda tecnica

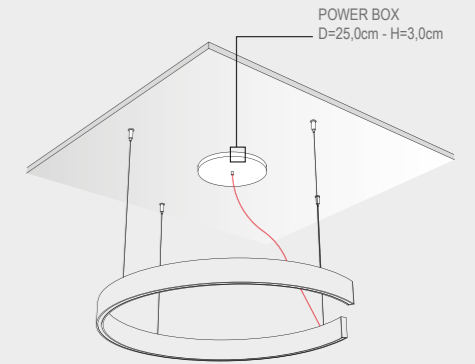

ALTIS CON BOX
ALTIS WITH POWER SUPPLY BOX

ATTENZIONE/PLEASE NOTE: SU RICHIESTA DIAMETRO CUSTOM / CUSTOM DIAMETER ON REQUEST

DATI TECNICI
TECHNICAL DATA

	D 45 cm	D 55 cm	D 75 cm
Nominal LED Flux:	↑2370 lm - 4740 lm ↓	↑3002 lm - 6004 lm ↓	↑4108 lm - 8216 lm ↓
Flux Tot:	↑1896 lm - 3792 lm ↓	↑2402 lm - 4803 lm ↓	↑3286 lm - 6573 lm ↓
Output:	158 lm/W	158 lm/W	158 lm/W
CCT:	3000 K	3000 K	3000 K
CRI:	>90	>90	>90
Power:	↑15.0W - 30.0W ↓	↑19.0W - 38.0W ↓	↑26.0W - 52.0W ↓
Power Tot:	45.0W	57.0W	78.0W
Weight:	1.42 Kg	1.90 Kg	2.50 Kg

Profilo/Profile: Alluminio/aluminum

Cover: Satinata/satin



MODELLO DI INSTALLAZIONE
INSTALLATION MODEL

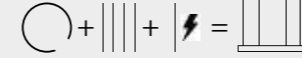

N°4 CAVI SOSPENSIONE + ALIMENTAZIONE
N°4 SUSPENSION + POWER CABLES

DRIVER 24V ON/OFF INCLUSO
PER INSTALLAZIONE IN REMOTO
DRIVER 24V INCLUDED
FOR REMOTE INSTALLATION

CAVO ALIMENTAZIONE TRASPARENTE: 200 cm
TRANSPARENT ALIMENTATION CABLE: 200 cm
CAVI SOSPENSIONE IN ACCIAIO: 200 cm
SUSPENSION CABLES IN STEEL: 200 cm

FINITURA STRUTTURA FINISHES	COLORE CAVO WIRE COLOR	D 45 cm CODICE CODE	D 55 cm CODICE CODE	D 75 cm CODICE CODE
BIANCO INTONACO/WHITE	TRASPARENTE TRANSPARENT	4155031045	4155031055	4155031075
NERO CARAVAGGIO/BLACK		4155041045	4155041055	4155041075
CROMO/CHROME		4155081045	4155081055	4155081075
ORO CALIFORNIA/GOLD		4155091045	4155091055	4155091075
ARAMEN COPPER		4155101045	4155101055	4155101075
GRIGIO AVIO/ GREY AVIO		4155111045	4155111055	4155111075
ARGENTO COMETA/SILVER COMET		4155121045	4155121055	4155121075
TITANIO/TITANIUM		4155141045	4155141055	4155141075
BRONZO RIACI/RIACI BRONZE		4155151045	4155151055	4155151075
VERDE COSTA/GREEN COAST		4155161045	4155161055	4155161075

FINITURA STRUTTURA FINISHES	COLORE CAVO WIRE COLOR	D 45 cm CODICE CODE	D 55 cm CODICE CODE	D 75 cm CODICE CODE
BIANCO INTONACO/WHITE	ACCIAIO STEEL	4155032045	4155032055	4155032075
NERO CARAVAGGIO/BLACK		4155042045	4155042055	4155042075
CROMO/CHROME		4155082045	4155082055	4155082075
ORO CALIFORNIA/GOLD		4155092045	4155092055	4155092075
ARAMEN COPPER		4155102045	4155102055	4155102075
GRIGIO AVIO/ GREY AVIO		4155112045	4155112055	4155112075
ARGENTO COMETA/SILVER COMET		4155122045	4155122055	4155122075
TITANIO/TITANIUM		4155142045	4155142055	4155142075
BRONZO RIACI/RIACI BRONZE		4155151045	4155151055	4155151075
VERDE COSTA/GREEN COAST		4155161045	4155161055	4155161075

BOX DI ALIMENTAZIONE CON FORI RADIALI /
POWER SUPPLY BOX WITH RADIAL HOLES

FINITURA STRUTTURA FINISHES	TIPOLOGIA TYPE	60W CODICE CODE	96W CODICE CODE	120W (2x60W) CODICE CODE	192W (2x96W) CODICE CODE
BIANCO INTONACO/WHITE	ON/OFF	T03060	T03096	T03120	T03192
	DALI	D03060	D03096	D03120	D03192

N.B.: VERSIONE 120W E 192W CON-
FIGURATI PER DOPPIA ACCENSIONE
/ PLEASE NOTE: 120W AND 192W
VERSION CONFIGURED FOR DOUBLE
IGNITION

BOX DI ALIMENTAZIONE CON FORO CENTRALE /
POWER SUPPLY BOX WITH CENTRAL HOLE

FINITURA STRUTTURA / FINISHES	BIANCO INTONACO/WHITE				
TIPOLOGIA TYPE	60W CODICE CODE	96W CODICE CODE	120W (2x60W) CODICE CODE	156W CODICE CODE	192W (2x96W) CODICE CODE
ON/OFF	F03060	F03096	F03120	F03156	F03192
DALI	S03060	S03096	S03120	S03156	S03192

N.B.: VERSIONE 120W E 192W CONFIGURATI
PER DOPPIA ACCENSIONE / PLEASE NOTE:
120W AND 192W VERSION CONFIGURED FOR
DOUBLE IGNITION



“elisse come orbite”

ORBITA prosegue il progetto di Design Luce iniziato con OLIMPIA. L'ellisse è la naturale conseguenza del cerchio, una forma armonica che richiama le orbite che i corpi celesti descrivono intorno al Sole. ORBITA racchiude in sé tutta l'eleganza e la leggerezza di una lampada LED dagli elevati contenuti tecnici ed illuminotecnici.

ORBITA continues the Design Luce project started with OLIMPIA. The ellipse is a natural consequence of the circle, an harmonic form which recalls the orbit of celestial bodies. Around the sun. ORBITA embodies the elegance and lightness of a LED lamp with very high technical contents.





Amin = 120,00 cm / Amax = 220,00 cm
Bmin = 60,00 cm / Bmax = 110,00 cm

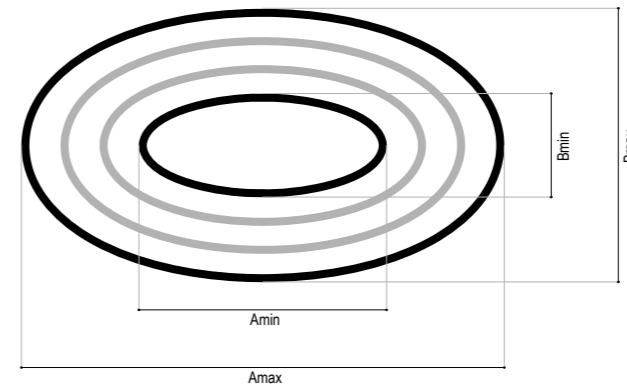

Il prodotto verrà fornito come unica ellisse
The product will be supplied as a single ellipse

A > 220,00 cm
B > 110,00 cm

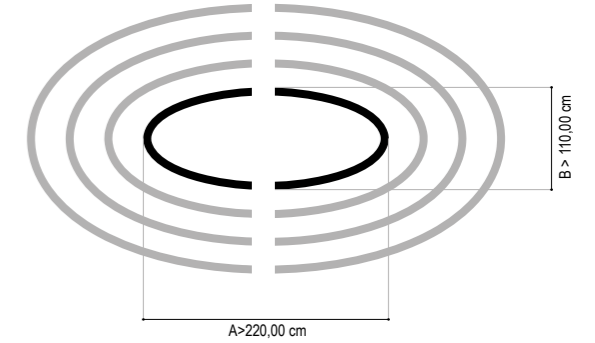

Il prodotto verrà fornito in più archi di ellisse da giungere
The product will be supplied in several ellipse arcs to be joined

Gli schemi riportati nelle presenti schede sono puramente indicativi.
Ogni richiesta di customizzazione va sottoposta esclusivamente alla Design Luce srlu che ne valuterà la fattibilità tecnica.

The diagrams shown in these sheets are purely indicative.
Any request for customization must be submitted exclusively to the Design Luce srlu which will evaluate its technical feasibility.

BOX COPRIMORSETTI / TERMINAL BOX

DATI TECNICI TECHNICAL DATA	DIMENSIONI (ln x lg x h) DIMENSIONS	FINITURA FINISHES	CODICE CODE
Tensione/Voltage: 24V - CC SELV / 220-240v - 50-60 Hz Power Factor > 0.9 at > 50% load DC Operation 176-264v DC Ambient Temperature: -15°C to 60°C	<p>2,3 cm 7,8 cm</p>	<p>BIANCO/WHITE NERO/BLACK</p>	<p>10403 10404</p>

N.B. DA ORDINARE NELLA VERSIONE CON DRIVER REMOTO
TO BE ORDERED IN THE VERSION WITH REMOTE DRIVER

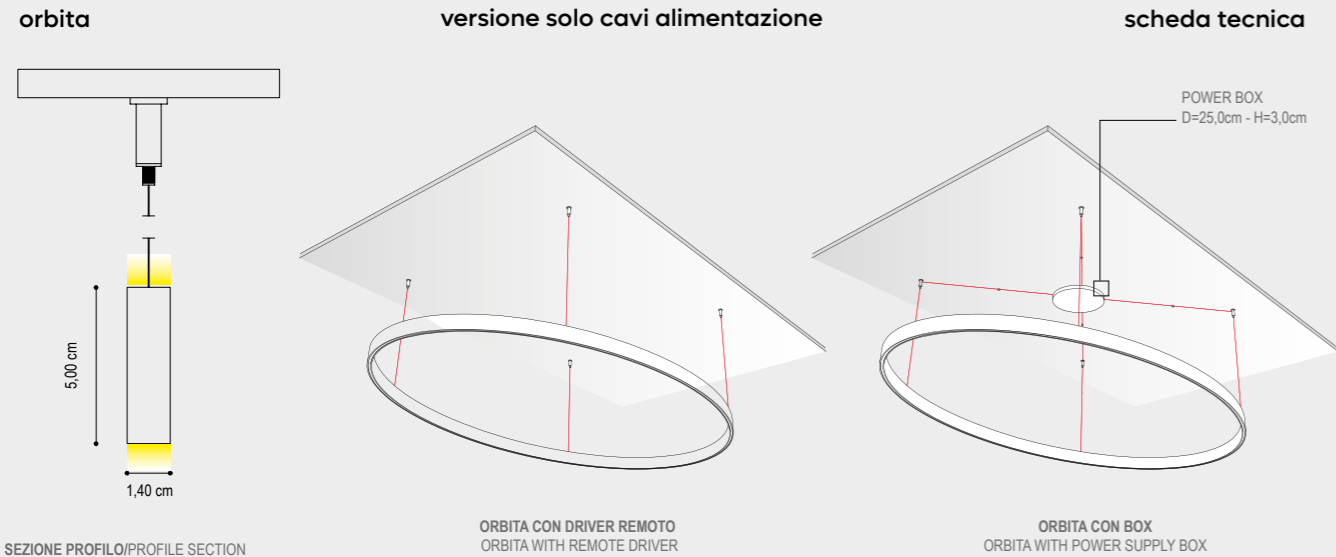

SEZIONE PROFILO/PROFILE SECTION

ORBITA CON DRIVER REMOTO
ORBITA WITH REMOTE DRIVER

ORBITA CON BOX
ORBITA WITH POWER SUPPLY BOX

ATTENZIONE/PLEASE NOTE: SU RICHIESTA DIAMETRO CUSTOM / CUSTOM DIAMETER ON REQUEST

DATI TECNICI
TECHNICAL DATA

COMPOSIZIONE A1
120 cm / 60 cm

COMPOSIZIONE A2
160 cm / 80 cm

Nominal LED Flux:	↑ 5688 lm - 11218 lm ↓	↑ 7584 lm - 15010 lm ↓
Flux Tot:	↑ 4550 lm - 8974 lm ↓	↑ 6067 lm - 12008 lm ↓
Output:	158 lm/W	158 lm/W
CCT:	3000 K	3000 K
CRI:	>90	>90
Power:	↑ 36.0W - 71.0W ↓	↑ 48.0W - 95.0W ↓
Power Tot:	107.0W	143.0W
Weight:	3.60 Kg	2.50 Kg

Profilo/Profile: Alluminio/aluminum

Cover: Satinata/satin

MODELLO DI INSTALLAZIONE
INSTALLATION MODEL

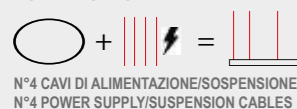

N°4 CAVI DI ALIMENTAZIONE/SOSPENSIONE
N°4 POWER SUPPLY/SUSPENSION CABLES

DRIVER 24V ON/OFF INCLUSO
PER INSTALLAZIONE IN REMOTO
DRIVER 24V ON/OFF INCLUDED
FOR REMOTE INSTALLATION

CAVO ALIMENTAZIONE/SOSPENSIONE: 200 cm
SUSPENSION ALIMENTATION CABLE: 200 cm

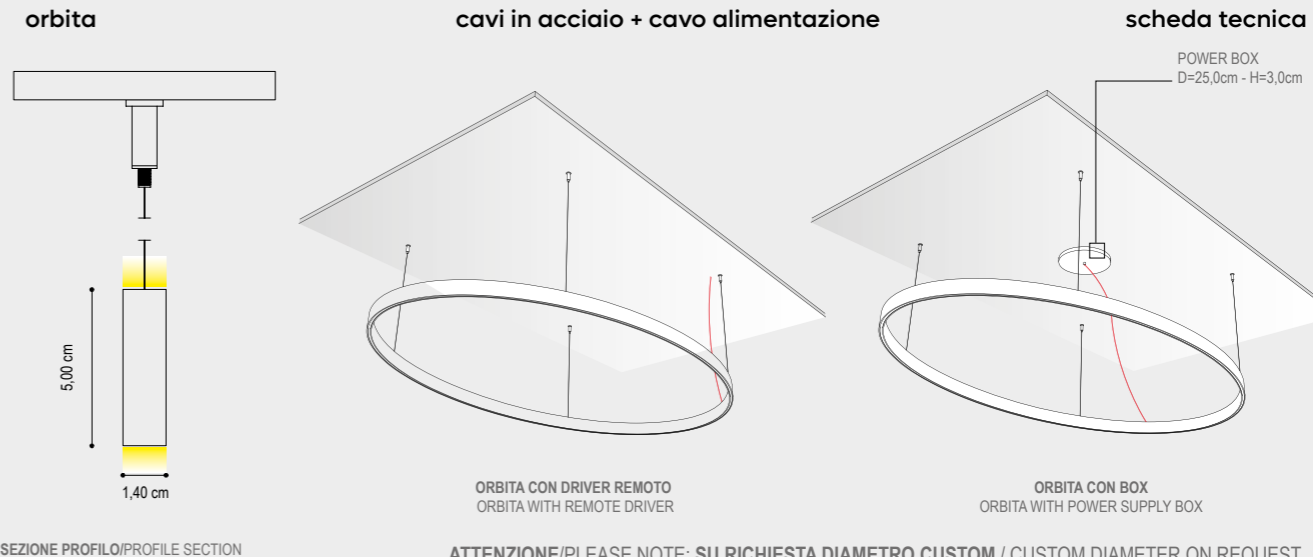

SEZIONE PROFILO/PROFILE SECTION

ORBITA CON DRIVER REMOTO
ORBITA WITH REMOTE DRIVER

ORBITA CON BOX
ORBITA WITH POWER SUPPLY BOX

ATTENZIONE/PLEASE NOTE: SU RICHIESTA DIAMETRO CUSTOM / CUSTOM DIAMETER ON REQUEST

DATI TECNICI
TECHNICAL DATA

COMPOSIZIONE B1
120 cm / 60 cm

COMPOSIZIONE B2
160 cm / 80 cm

Nominal LED Flux:	↑ 5688 lm - 11218 lm ↓	↑ 7584 lm - 15010 lm ↓
Flux Tot:	↑ 4550 lm - 8974 lm ↓	↑ 6067 lm - 12008 lm ↓
Output:	158 lm/W	158 lm/W
CCT:	3000 K	3000 K
CRI:	>90	>90
Power:	↑ 36.0W - 71.0W ↓	↑ 48.0W - 95.0W ↓
Power Tot:	107.0W	143.0W
Weight:	3.60 Kg	2.50 Kg

Profilo/Profile: Alluminio/aluminum

Cover: Satinata/satin



MODELLO DI INSTALLAZIONE
INSTALLATION MODEL



N°4 CAVI SOSPENSIONE + ALIMENTAZIONE
N°4 SUSPENSION + POWER CABLES

DRIVER 24V ON/OFF INCLUSO
PER INSTALLAZIONE IN REMOTO
DRIVER 24V ON/OFF INCLUDED
FOR REMOTE INSTALLATION

CAVO ALIMENTAZIONE TRASPARENTE: 200 cm
TRASPARENT ALIMENTATION CABLE: 200 cm
CAVI SOSPENSIONE IN ACCIAIO: 200 cm
SUSPENSION CABLES IN STEEL: 200 cm

FINITURA STRUTTURA
FINISHES

- BIANCO INTONACO/WHITE
- NERO CARAVAGGIO/BLACK
- ORO CALIFORNIA/GOLD
- ARAMEN COPPER
- ARGENTO COMETA/SILVER COMET
- OTTONE VENEZIANO/VENETIAN BRASS
- TITANIO/TITANIUM
- BRONZO RIACI/RIACI BRONZE
- VERDE COSTA/GREEN COAST

COLORE CAVO
WIRE COLOR

- TRASPARENTE
TRANSPARENT

COMPOSIZIONE A1
120 cm / 60 cm

COMPOSIZIONE A2
160 cm / 80 cm

CODICE CODE	CODICE CODE
405503A1	405503A2
405504A1	405504A2
405509A1	405509A2
405510A1	405510A2
405512A1	405512A2
405513A1	405513A2
405514A1	405514A2
405515A1	405515A2
405516A1	405516A2

FINITURA STRUTTURA
FINISHES

- BIANCO INTONACO/WHITE
- NERO CARAVAGGIO/BLACK
- ORO CALIFORNIA/GOLD
- ARAMEN COPPER
- ARGENTO COMETA/SILVER COMET
- OTTONE VENEZIANO/VENETIAN BRASS
- TITANIO/TITANIUM
- BRONZO RIACI/RIACI BRONZE
- VERDE COSTA/GREEN COAST

COLORE CAVO
WIRE COLOR

- ACCIAIO
STEEL
- TRASPARENTE
TRANSPARENT

COMPOSIZIONE B1
120 cm / 60 cm

COMPOSIZIONE B2
160 cm / 80 cm

CODICE CODE	CODICE CODE
405503B1	405503B2
405504B1	405504B2
405509B1	405509B2
405510B1	405510B2
405512B1	405512B2
405513B1	405513B2
405514B1	405514B2
405515B1	405515B2
405516B1	405516B2

BOX DI ALIMENTAZIONE CON FORI RADIALI /
POWER SUPPLY BOX WITH RADIAL HOLES

FINITURA STRUTTURA FINISHES	TIPOLOGIA TYPE	60W	96W	120W (2x60W)	192W (2x96W)
		CODICE CODE	CODICE CODE	CODICE CODE	CODICE CODE
BIANCO INTONACO/WHITE	ON/OFF	T03060	T03096	T03120	T03192
	DALI	D03060	D03096	D03120	D03192

N.B.: VERSIONE 120W E 192W CON-
FIGURATI PER DOPPIA ACCENSIONE
/ PLEASE NOTE: 120W AND 192W
VERSION CONFIGURED FOR DOUBLE
IGNITION

BOX DI ALIMENTAZIONE CON FORO CENTRALE /
POWER SUPPLY BOX WITH CENTRAL HOLE

TIPOLOGIA TYPE	FINITURA STRUTTURA / FINISHES				
	60W	96W	120W (2x60W)	156W	192W (2x96W)
ON/OFF	F03060	F03096	F03120	F03156	F03192
DALI	S03060	S03096	S03120	S03156	S03192

N.B.: VERSIONE 120W E 192W CONFIGURATI
PER DOPPIA ACCENSIONE / PLEASE NOTE:
120W AND 192W VERSION CONFIGURED FOR
DOUBLE IGNITION



“forma e funzionalità”

GIOTTO è il risultato in cui l'ordine proporzionale della forma si incontra con la funzionalità dove il prodotto diventa oggetto e complemento d'arredo. Grazie alle sue ottiche posizionate sull'asse orizzontale consente di illuminare ambienti in cui è richiesta una luce trasversale sull'asse orizzontale.

GIOTTO is the result in which the proportional order of the form meets the functionality. The product becomes an object and a furniture. Thanks to its optics placed on the horizontal axis, Giotto allows the lighting of all environments in which this kind light is needed.



giotto

Dmin = 70,00 cm / Dmax = 180,00 cm

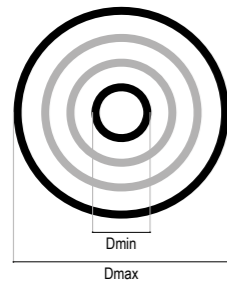

Il prodotto verrà fornito come unica circonferenza
The product will be supplied as a single circumference

D > 180,00 cm

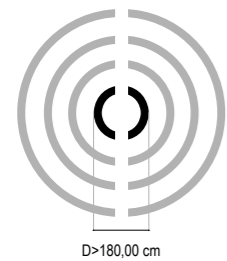

Il prodotto verrà fornito in più archi di circonferenza da giuntare
The product will be supplied in several circumference arcs to be joined

customizzazione

customization

giotto

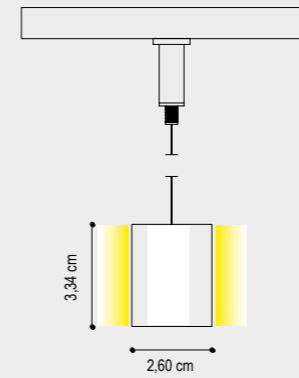

SEZIONE PROFILO/PROFILE SECTION

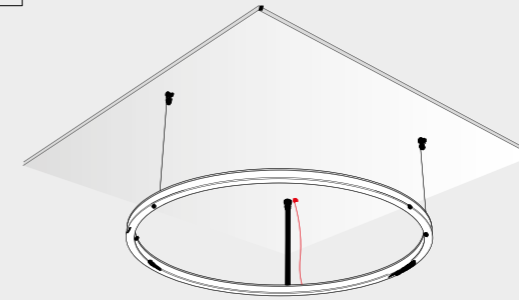

GIOTTO CON DRIVER REMOTO
GIOTTO WITH REMOTE DRIVER

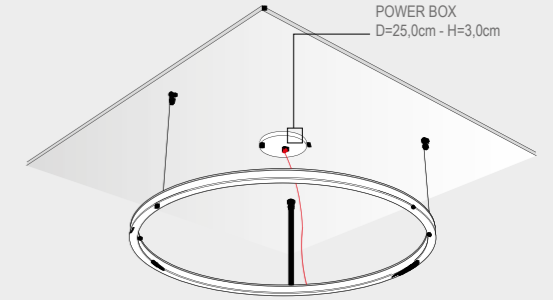

GIOTTO CON BOX
GIOTTO WITH POWER SUPPLY BOX

ATTENZIONE/PLEASE NOTE: SU RICHIESTA DIAMETRO CUSTOM / CUSTOM DIAMETER ON



MODELLO DI INSTALLAZIONE
INSTALLATION MODEL

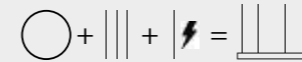

N°3 CAVI SOSPENSIONE + ALIMENTAZIONE
N° 3 SUSPENSION + POWER CABLES

DRIVER 24V ON/OFF INCLUSO
PER INSTALLAZIONE IN REMOTO
DRIVER 24V ON/OFF INCLUDED
FOR REMOTE INSTALLATION

CAVO ALIMENTAZIONE TRASPARENTE: 200 cm
TRANSPARENT ALIMENTATION CABLE: 200 cm
CAVI SOSPENSIONE IN ACCIAIO: 200 cm
SUSPENSION CABLES IN STEEL: 200 cm

DATI TECNICI
TECHNICAL DATA

	D 70 cm	D 90 cm	D 110 cm
Nominal LED Flux:	4435 lm - 4435 lm	5705 lm - 5705 lm	6955 lm - 6955 lm
Flux Tot:	3548 lm - 3548 lm	4564 lm - 4564 lm	5564 lm - 5564 lm
Output:	105 lm/W	105 lm/W	105 lm/W
CCT:	3000 K	3000 K	3000 K
CRI:	>95	>95	>95
Power:	42.0W - 42.0W	54.0W - 54.0W	74.5W - 74.5W
Power Tot:	84.0W	108.0W	132.0W
Weight:	2.10 Kg	3.10 Kg	3.70 Kg

Profilo/Profile: Alluminio/aluminum

Cover: Opale/opal

FINITURA STRUTTURA
FINISHES

- BIANCO INTONACO/WHITE
- NERO CARAVAGGIO/BLACK
- CROMO/CHROME
- ORO CALIFORNIA/GOLD
- ARAMEN COPPER
- ARGENTO COMETA/SILVER COMET
- OTTONE VENEZIANO/VENETIAN BRASS
- TITANIO/TITANIUM
- BRONZO RIACI/RIACI BRONZE
- VERDE COSTA/GREEN COAST

COLORE CAVO
WIRE COLOR

- ACCIAIO
STEEL
- TRASPARENTE
TRANSPARENT

	D 70 cm	D 90 cm	D 110 cm
CODICE CODE	4326031070	4326031090	4326031110
	4326041070	4326041090	4326041110
	4326081070	4326081090	4326081110
	4326091070	4326091090	4326091110
	4326101070	4326101090	4326101110
	4326121070	4326121090	4326121110
	4326131070	4326131090	4326131110
	4326141070	4326141090	4326141110
	4326151070	4326151090	4326151110
	4326161070	4326161090	4326161110

BOX DI ALIMENTAZIONE CON FORO CENTRALE /
POWER SUPPLY BOX WITH CENTRAL HOLE

FINITURA STRUTTURA / FINISHES		BIANCO INTONACO/WHITE				
	60W	96W	120W (2x60W)	156W	192W (2x96W)	
TIPOLOGIA TYPE	CODICE CODE	CODICE CODE	CODICE CODE	CODICE CODE	CODICE CODE	
ON/OFF	F03060	F03096	F03120	F03156	F03192	
DALI	S03060	S03096	S03120	S03156	S03192	

N.B.: VERSIONE 120W E 192W CONFIGURATI
PER DOPPIA ACCENSIONE / PLEASE NOTE:
120W AND 192W VERSION CONFIGURED FOR
DOUBLE IGNITION

Per il dimensionamento della sezione del cavo di alimentazione contattare il Nostro reparto tecnico.
For the sizing of the power cable section, contact our technical department.

Gli schemi riportati nelle presenti schede sono puramente indicativi.
Ogni richiesta di customizzazione va sottoposta esclusivamente alla Design Luce srlu che ne valuterà la fattibilità tecnica.
The diagrams shown in these sheets are purely indicative.
Any request for customization must be submitted exclusively to the Design Luce srlu which will evaluate its technical feasibility.



“luce trasversale”

KRONOS è il risultato speculare della famiglia OLIMPIA. La sua sobria geometria circolare, abbinata allo studio dei LED e di ottiche di ultima generazione, assicura al progettista una luce trasversale, ideale da inserire in tutti gli spazi architettonici dove viene richiesta una luce diretta/indiretta sull'asse orizzontale.

KRONOS is the specular result of the OLIMPIA family. Its sober circular geometry, together with the study of the latest LEDs and optics generation ensures a transversal light, ideal for all architectural spaces.



kronos

customizzazione

customization

Dmin = 70,00 cm / Dmax = 180,00 cm

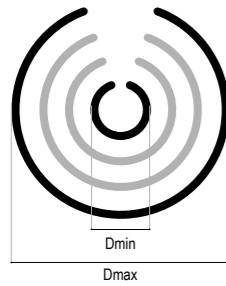

Il prodotto verrà fornito come unica circonferenza
The product will be supplied as a single circumference

D > 180,00 cm

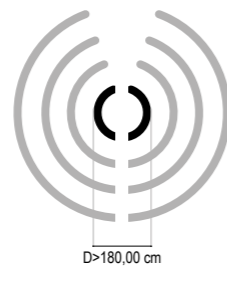

Il prodotto verrà fornito in più archi di circonferenza da giuntare
The product will be supplied in several circumference arcs to be joined



Per il dimensionamento della sezione del cavo di alimentazione contattare il Nostro reparto tecnico.
For the sizing of the power cable section, contact our technical department.

Gli schemi riportati nelle presenti schede sono puramente indicativi.

Ogni richiesta di customizzazione va sottoposta esclusivamente alla Design Luce srlu che ne valuterà la fattibilità tecnica.

The diagrams shown in these sheets are purely indicative. Any request for customization must be submitted exclusively to the Design Luce srlu which will evaluate its technical feasibility.

kronos

scheda tecnica

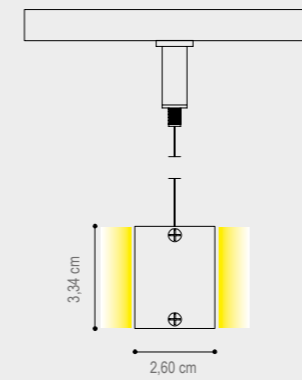

SEZIONE PROFILO/PROFILE SECTION

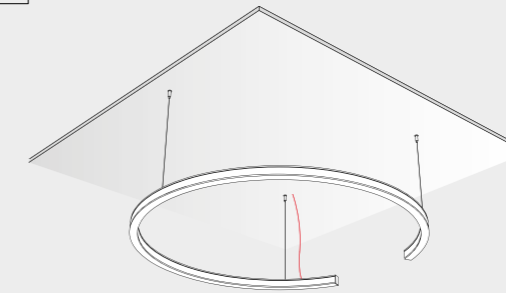

KRONOS CON DRIVER REMOTO
KRONOS WITH REMOTE DRIVER

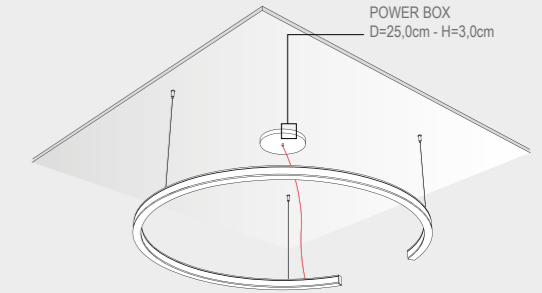

KRONOS CON BOX
KRONOS WITH POWER SUPPLY BOX

ATTENZIONE/PLEASE NOTE: SU RICHIESTA DIAMETRO CUSTOM / CUSTOM DIAMETER ON REQUEST



MODELLO DI INSTALLAZIONE
INSTALLATION MODEL

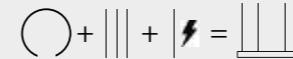

N°3 CAVI SOSPENSIONE + ALIMENTAZIONE
N° 3 SUSPENSION + POWER CABLES

DRIVER 24V ON/OFF INCLUSO
PER INSTALLAZIONE IN REMOTO
DRIVER 24V ON/OFF INCLUDED
FOR REMOTE INSTALLATION

CAVO ALIMENTAZIONE TRASPARENTE: 200 cm
TRANSPARENT ALIMENTATION CABLE: 200 cm
CAVI SOSPENSIONE IN ACCIAIO: 200 cm
SUSPENSION CABLES IN STEEL: 200 cm

DATI TECNICI
TECHNICAL DATA

	D 70 cm	D 90 cm	D 110 cm
Nominal LED Flux:	5895 lm - 5895 lm	7729 lm - 7729 lm	9497 lm - 9497 lm
Flux Tot:	4716 lm - 4716 lm	6183 lm - 6183 lm	7598 lm - 7598 lm
Output:	130 lm/W	130 lm/W	130 lm/W
CCT:	3000 K	3000 K	3000 K
CRI:	>90	>90	>90
Power:	45.0W - 45.0W	59.0W - 59.0W	72.5W - 72.5W
Power Tot:	90.0W	118.0W	145.0W
Weight:	2.00 Kg	3.00 Kg	3.50 Kg

Profilo/Profile: Alluminio/aluminum

Cover: Opale/opal

FINITURA STRUTTURA
FINISHES

- BIANCO INTONACO/WHITE
- NERO CARAVAGGIO/BLACK
- CROMO/CHROME
- ORO CALIFORNIA/GOLD
- ARAMEN COPPER
- ARGENTO COMETA/SILVER COMET
- OTTONE VENEZIANO/VENETIAN BRASS
- TITANIO/TITANIUM
- BRONZO RIACI/RIACI BRONZE
- VERDE COSTA/GREEN COAST

COLORE CAVO
WIRE COLOR

- ACCIAIO
STEEL
- TRASPARENTE
TRANSPARENT

	D 70 cm	D 90 cm	D 110 cm
CODICE CODE	4226031070	4226031090	4226031110
CODICE CODE	4226041070	4226041090	4226041110
CODICE CODE	4226081070	4226081090	4226081110
CODICE CODE	4226091070	4226091090	4226091110
CODICE CODE	4226101070	4226101090	4226101110
CODICE CODE	4226121070	4226121090	4226121110
CODICE CODE	4226131070	4226131090	4226131110
CODICE CODE	4226141070	4226141090	4226141110
CODICE CODE	4226151070	4226151090	4226151110
CODICE CODE	4226161070	4226161090	4226161110

BOX DI ALIMENTAZIONE CON FORO CENTRALE /
POWER SUPPLY BOX WITH CENTRAL HOLE

FINITURA STRUTTURA / FINISHES

BIANCO INTONACO/WHITE

	60W	96W	120W (2x60W)	156W	192W (2x96W)
TIPOLOGIA TYPE	CODICE CODE	CODICE CODE	CODICE CODE	CODICE CODE	CODICE CODE
ON/OFF	F03060	F03096	F03120	F03156	F03192
DALI	S03060	S03096	S03120	S03156	S03192

N.B.: VERSIONE 120W E 192W CONFIGURATI
PER DOPPIA ACCENSIONE / PLEASE NOTE:
120W AND 192W VERSION CONFIGURED FOR
DOUBLE IGNITION



“forma e funzionalità chiusa”

ERACLE, piccolo e bello: la continua ricerca dell'innovazione ha portato Design Luce a pensare a una geometria circolare e di dimensioni estremamente ridotte. ERACLE si adatta a tutti gli spazi dando quel tocco di eleganza e la giusta luce.

ERACLE, small and beautiful: the continuous research for innovation has led Design Luce to create a circular geometry with extremely small dimensions. ERACLE suits all spaces giving them a touch of elegance and the right light.



Dmin = 55,00 cm / Dmax = 120,00 cm

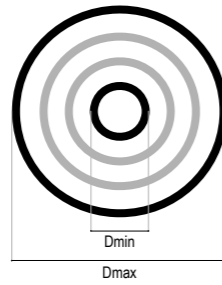

Il prodotto verrà fornito come unica circonferenza
The product will be supplied as a single circumference



Per il dimensionamento della sezione del cavo di alimentazione contattare il Nostro reparto tecnico.
For the sizing of the power cable section, contact our technical department.

Gli schemi riportati nelle presenti schede sono puramente indicativi. Ogni richiesta di customizzazione va sottoposta esclusivamente alla Design Luce srlu che ne valuterà la fattibilità tecnica.
The diagrams shown in these sheets are purely indicative. Any request for customization must be submitted exclusively to the Design Luce srlu which will evaluate its technical feasibility.

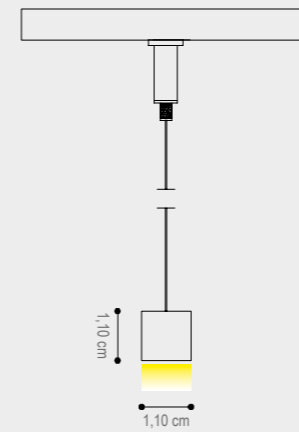

SEZIONE PROFILO/PROFILE SECTION

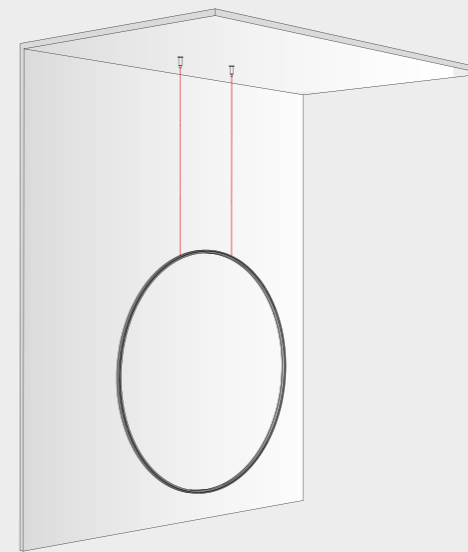

ERACLE CON DRIVER REMOTO
ERACLE WITH REMOTE DRIVER

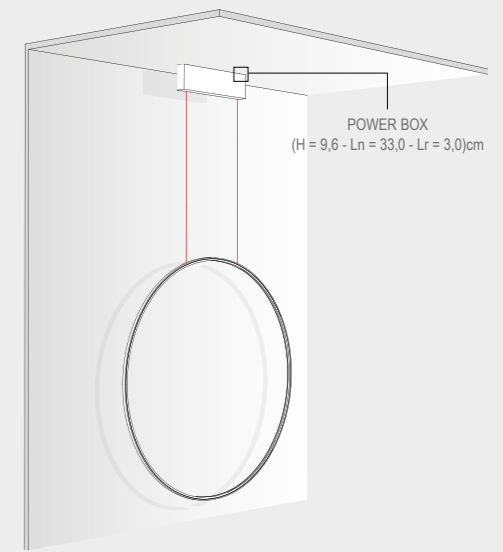

ERACLE CON BOX
ERACLE WITH POWER SUPPLY BOX



CAVO ALIMENTAZIONE/SOSPENSIONE: 200 cm
SUSPENSION ALIMENTATION CABLE: 200 cm



DATI TECNICI
TECHNICAL DATA

Nominal LED Flux:	2612 lm
Flux Tot:	2090 lm
Output:	105 lm/W
CCT:	3000 K
CRI:	>90
Power Tot:	25.0W
Weight:	1.42 Kg

FINITURA STRUTTURA FINISHES	CODICE CODE	D 55 cm DRIVER ON/OFF INCLUSO	D 55 cm BOX ON/OFF INCLUSO	D 55 cm BOX DALI INCLUSO
ARGILLA CLAY	42E01055		⏚	⏚
BIANCO INTONACO/WHITE	42E03055			
NERO CARAVAGGIO BLACK	42E04055			
CROMO CHROME	42E08055			
ORO CALIFORNIA GOLD	42E09055			
ARAMEN COPPER	42E10055			
OTTONE VENEZIANO/VENETIAN BRASS	42E13055			
TITANIO/TITANIUM	42E14055			
BRONZO RIACI/RIACI BRONZE	42E15055			
VERDE COSTA/GREEN COAST	42E16055			

ATTENZIONE/PLEASE NOTE: SU RICHIESTA DIAMETRO CUSTOM / CUSTOM DIAMETER ON REQUEST

IL BOX IN DOTAZIONE È SEMPRE IN FINITURA BIANCO INTONACO. A RICHIESTA SI PUÒ ORDINARE NELLE ALTRE FINITURE A CATALOGO / THE BOX PROVIDED IS ALWAYS IN PLASTER WHITE FINISH. ON REQUEST YOU CAN HAVE OTHER CATALOG FINISHES.



“forma e funzionalità aperta”

HERA, piccolo e bello: la continua ricerca dell'innovazione ha portato Design Luce a pensare a una geometria circolare e di dimensioni estremamente ridotte.

HERA si adatta a tutti gli spazi dando quel tocco di eleganza e la giusta luce.

HERA small and beautiful: the continuous research for innovation has led Design Luce to create a circular geometry with extremely small dimensions. HERA suits all spaces giving them a touch of elegance

and the right light.



Dmin = 55,00 cm / Dmax = 120,00 cm

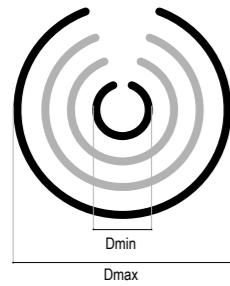

Il prodotto verrà fornito come unica circonferenza
The product will be supplied as a single circumference



Per il dimensionamento della sezione del cavo di alimentazione contattare il Nostro reparto tecnico.
For the sizing of the power cable section, contact our technical department.

Gli schemi riportati nelle presenti schede sono puramente indicativi.
Ogni richiesta di customizzazione va sottoposta esclusivamente alla Design Luce srlu che ne valuterà la fattibilità tecnica.
The diagrams shown in these sheets are purely indicative.
Any request for customization must be submitted exclusively to the Design Luce srlu which will evaluate its technical feasibility.

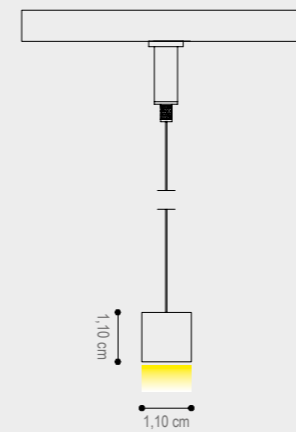

SEZIONE PROFILO/PROFILE SECTION



HERA CON DRIVER REMOTO
HERA WITH REMOTE DRIVER

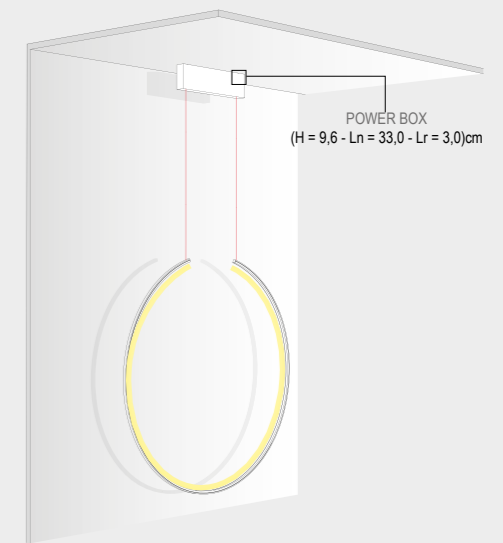

HERA CON BOX
HERA WITH POWER SUPPLY BOX

MODELLO DI INSTALLAZIONE
INSTALLATION MODEL

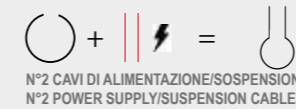

N°2 CAVI DI ALIMENTAZIONE/SOSPENSIONE
N°2 POWER SUPPLY/SUSPENSION CABLES

CAVO ALIMENTAZIONE/SOSPENSIONE: 200 cm
SUSPENSION ALIMENTATION CABLE: 200 cm



DATI TECNICI
TECHNICAL DATA

Nominal LED Flux: 2340 lm
Flux Tot: 1872 lm
Output: 105 lm/W
CCT: 3000 K
CRI: >90
Power Tot: 22.0W
Weight: 1.42 Kg

D 55 cm DRIVER ON/OFF INCLUSO D 55 cm BOX ON/OFF INCLUSO D 55 cm BOX DALI INCLUSO

FINITURA STRUTTURA FINISHES	CODICE CODE	CODICE CODE	CODICE CODE
ARGILLA CLAY	42H01055	42B01055	42D01055
BIANCO INTONACO/WHITE	42H03055	42B03055	42D03055
NERO CARAVAGGIO/BLACK	42H04055	42B04055	42D04055
CROMO/CHROME	42H08055	42B08055	42D08055
ORO CALIFORNIA/GOLD	42H09055	42B09055	42D09055
ARAMEN COPPER	42H10055	42B10055	42D10055
OTTONE VENEZIANO/VENETIAN BRASS	42H13055	42B13055	42D13055
TITANIO/TITANIUM	42H14055	42B14055	42D14055
BRONZO RIACI/RIACI BRONZE	42H15055	42B15055	42D15055
VERDE COSTA/GREEN COAST	42H16055	42B16055	42D16055

ATTENZIONE/PLEASE NOTE: SU RICHIESTA DIAMETRO CUSTOM / CUSTOM DIAMETER ON REQUEST

IL BOX IN DOTAZIONE È SEMPRE IN FINITURA BIANCO INTONACO. A RICHIESTA SI PUÒ ORDINARE NELLE ALTRE FINITURE A CATALOGO. THE BOX PROVIDED IS ALWAYS IN PLASTER WHITE FINISH. ON REQUEST YOU CAN HAVE OTHER CATALOG FINISHES.



“infinite declinazioni spaziali”

Il progetto XYZ si configura come un sistema cartesiano per illuminazione ad assetto variabile che parte da una composizione centrale per potersi sviluppare in infinite declinazioni adattabili alle diverse esigenze. Il concetto spaziale tecnico, creativo e poetico racchiude in sé il potenziale di espansione che viene messo a disposizione di chi, vedendola, la vorrà utilizzare ed interpretare.

XYZ is set up as a Cartesian system for tilting lighting, which starts from a central composition, with the clear objective to develop infinite variation for different needs. The special, technical, creative and poetic concept has a huge potential which is available for those who want to use and interpret it.towards free interpretations.





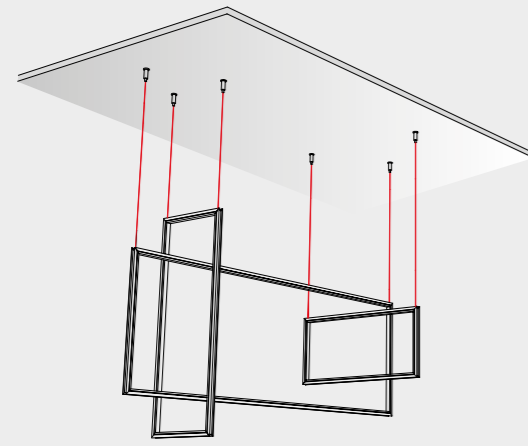

XYZ CON DRIVER REMOTO
XYZ WITH REMOTE DRIVER

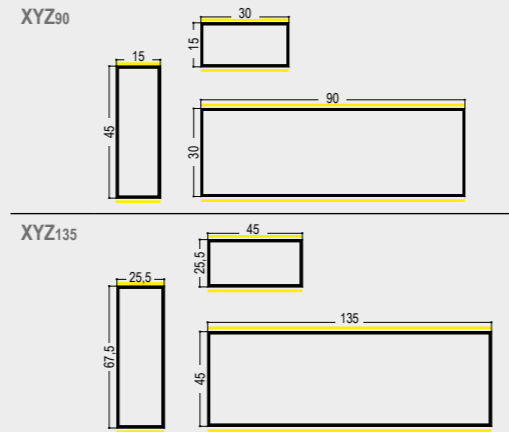

DATI TECNICI
TECHNICAL DATA

	XYZ90 - 33W	XYZ135 - 49W
Nominal LED Flux:	4950 lm	7350 lm
Flux Tot:	3960 lm	5880 lm
Output:	150 lm/W	150 lm/W
CCT:	3000 K	3000 K
CRI:	>90	>90
Power Tot:	33.0W	49.0W
Weight:	1.10 Kg	1.30 Kg

Profilo/Profile: Alluminio/aluminum

Cover: Opale/Opal

XYZ90 - 33W
DRIVER ON/OFF INCLUSO

FINITURA STRUTTURA
FINISHES

- BIANCO INTONACO/WHITE
- NERO CARAVAGGIO/BLACK

CODICE
CODE

- 10833TB303
- 10833TN303

XYZ135 - 49W
DRIVER ON/OFF INCLUSO

CODICE
CODE

- 10849TB303
- 10849TN303

XYZ90 - 33W
DRIVER DALI - SWITCH PUSH INCLUSO

FINITURA STRUTTURA
FINISHES

- BIANCO INTONACO/WHITE
- NERO CARAVAGGIO/BLACK

CODICE
CODE

- 10833SB303
- 10833SN303

XYZ135 - 49W
DRIVER DALI - SWITCH PUSH INCLUSO

CODICE
CODE

- 10849SB303
- 10849SN303

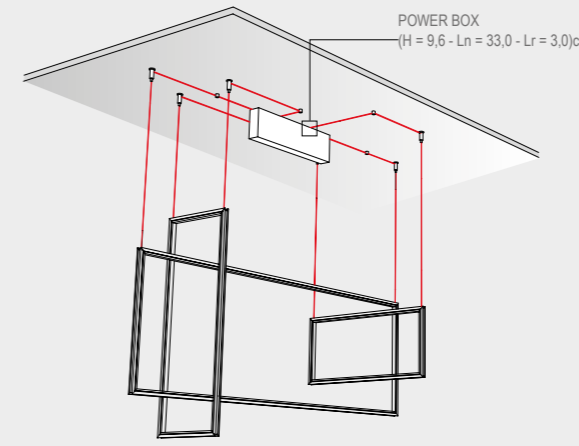

XYZ CON BOX
XYZ WITH POWER SUPPLY BOX

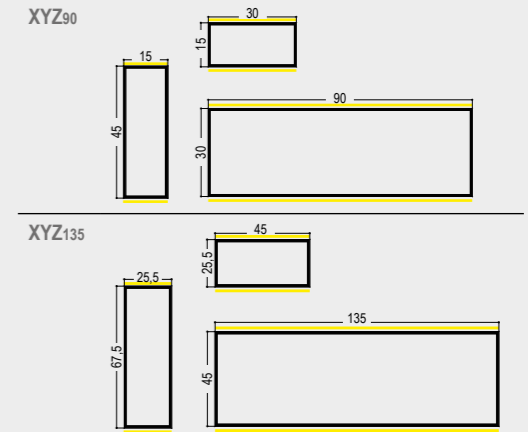

DATI TECNICI
TECHNICAL DATA

	XYZ90 - 33W	XYZ135 - 49W
Nominal LED Flux:	4950 lm	7350 lm
Flux Tot:	3960 lm	5880 lm
Output:	150 lm/W	150 lm/W
CCT:	3000 K	3000 K
CRI:	>90	>90
Power Tot:	33.0W	49.0W
Weight:	1.10 Kg	1.30 Kg

Profilo/Profile: Alluminio/aluminum

Cover: Opale/Opal

XYZ90 - 33W
BOX ON/OFF INCLUSO

FINITURA STRUTTURA
FINISHES

- BIANCO INTONACO/WHITE
- NERO CARAVAGGIO/BLACK

CODICE
CODE

- 10833BB303
- 10833BN303

XYZ135 - 49W
BOX ON/OFF INCLUSO

CODICE
CODE

- 10849BB303
- 10849BN303

IL BOX IN DOTAZIONE È SEMPRE IN FINITURA BIANCO INTONACO. A RICHIESTA SI PUÒ ORDINARE NELLE ALTRE FINITURE A CATALOGO. THE BOX PROVIDED IS ALWAYS IN PLASTER WHITE FINISH. ON REQUEST YOU CAN HAVE OTHER CATALOG FINISHES.

XYZ90 - 33W
BOX DALI - SWITCH PUSH INCLUSO

FINITURA STRUTTURA
FINISHES

- BIANCO INTONACO/WHITE
- NERO CARAVAGGIO/BLACK

CODICE
CODE

- 10833DB303
- 10833DN303

XYZ135 - 49W
BOX DALI - SWITCH PUSH INCLUSO

CODICE
CODE

- 10849DB303
- 10849DN303

IL BOX IN DOTAZIONE È SEMPRE IN FINITURA BIANCO INTONACO. A RICHIESTA SI PUÒ ORDINARE NELLE ALTRE FINITURE A CATALOGO. THE BOX PROVIDED IS ALWAYS IN PLASTER WHITE FINISH. ON REQUEST YOU CAN HAVE OTHER CATALOG FINISHES.

“mix di tecnologia e sensibilità”

La luce delle emozioni che si ricorda nel tempo. STELO nasce dal saper fare italiano e dalla continua ricerca della perfezione. L'ultima creazione di Design Luce è un mix di tecnologie e sensibilità che impiega una sottile ed elegante estrusione di alluminio sostenuta da esilissimi cavi per ottenere un apparecchio in grado di valorizzare con discrezione gli ambienti nei quali è inserito. Le sorgenti luminose di ultima generazione ed un evoluto diffusore in policarbonato in posizione arretrata assicurano l'assenza di abbagliamento e l'armoniosa integrazione con la luce naturale.

STELO The light of emotion that is remembered over time. STELO was born from the Italian know-how and the continuous search for perfection. Design Luce's latest creation is a mix of technology and sensibility that uses a thin and elegant aluminum extrusion supported by very thin cables in order to obtain a lamp able to enhance discreetly every environment. The technical characteristics of STELO ensure the absence of glare and the harmonious integration with natural light.

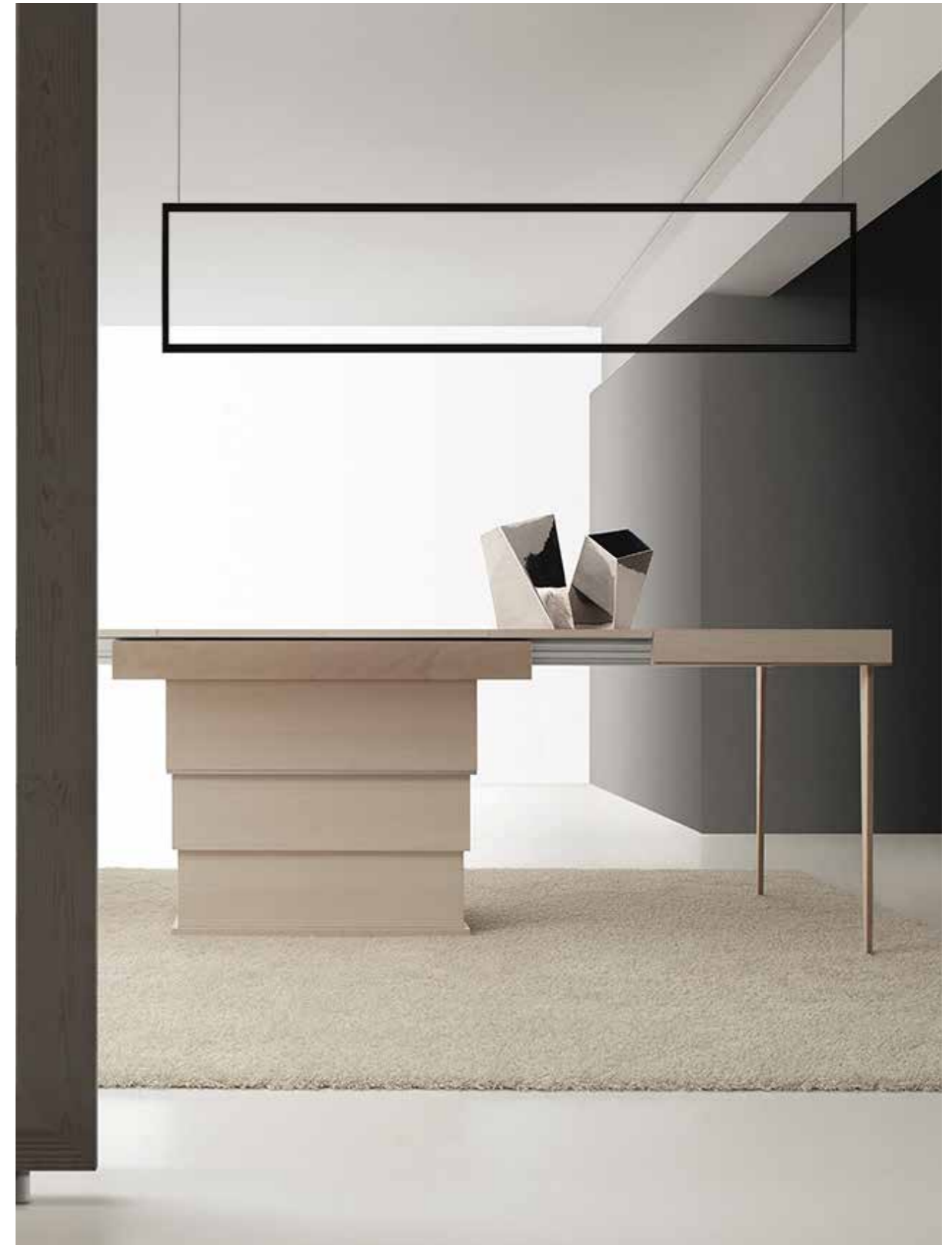

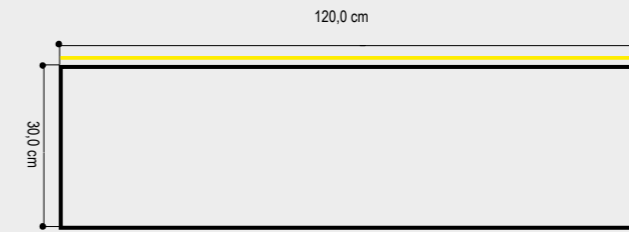
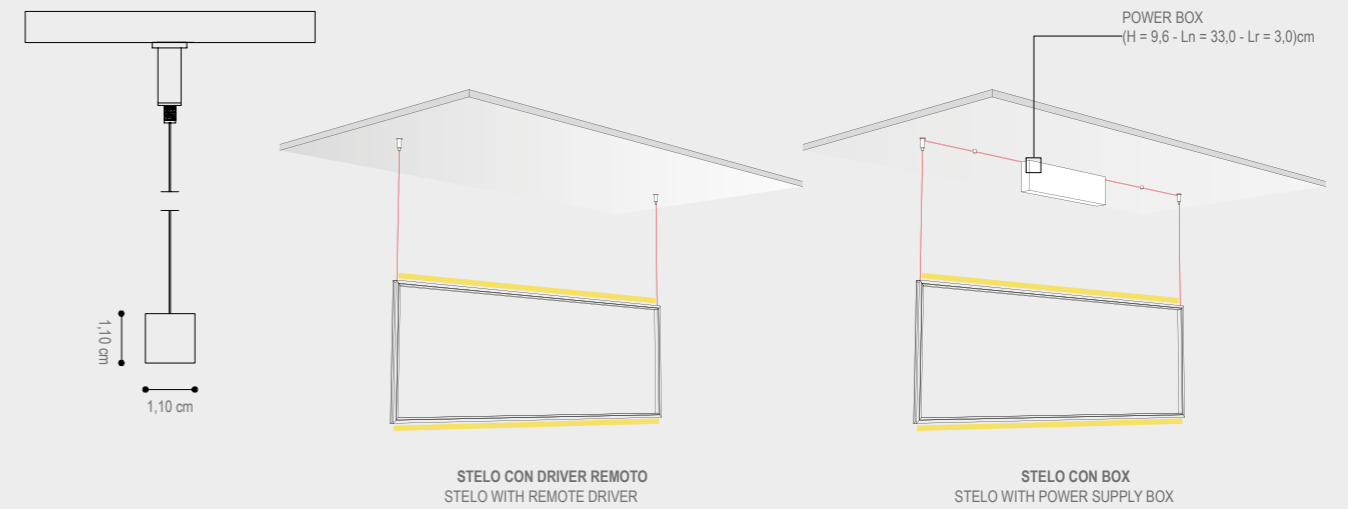

DATI TECNICI
TECHNICAL DATA

	120 x 30 cm
Nominal LED Flux:	↑ 1814 lm - 1814 lm ↓
Flux Tot:	↑ 1452 lm - 1452 lm ↓
Output:	105 lm/W
CCT:	3000 K
CRI:	>90
Power Tot:	29.0W
Weight:	1.00 Kg
Profilo/Profile:	Alluminio/aluminum
Cover:	Opale/opal

STELO 120 x 30 cm
DRIVER ON/OFF INCLUSO

CAVO ALIMENTAZIONE/SOSPENSIONE: 200 cm
SUSPENSION ALIMENTATION CABLE: 200 cm

STELO 120 x 30 cm
BOX ON/OFF INCLUSO

STELO 120 x 30 cm
BOX DALI INCLUSO

FINITURA STRUTTURA
FINISHES

ARGILLA CLAY
BIANCO INTONACO/WHITE
NERO CARAVAGGIO/BLACK

CODICE
CODE

10855ZA103
10855ZB103
10855ZN103

CODICE
CODE

10855XA103
10855XB103
10855XN103

CODICE
CODE

10855LA103
10855LB103
10855LN103

IL BOX IN DOTAZIONE È SEMPRE IN FINITURA BIANCO INTONACO. A RICHIESTA SI PUÒ ORDINARE NELLE ALTRE FINITURE A CATALOGO.
THE BOX PROVIDED IS ALWAYS IN PLASTER WHITE FINISH. ON REQUEST YOU CAN HAVE OTHER CATALOG FINISHES.



“luminosa emozione”

Una luminosa emozione perfettamente in linea con la filosofia di Design Luce. La perfetta combinazione di tecnologia e saper fare all'italiana è alla base di questo progetto che, impiegando una sottile estrusione di alluminio con led ad altissime prestazioni e schermo arretrato, ha dato origine a questo apparecchio.

Con APOTEMA Design Luce anticipa il futuro, la sua esile silhouette genera una morbida atmosfera che arricchisce gli ambienti nei quali è inserita questa eccellenza della nostra collezione. La particolare costruzione assicura un ottimo comfort visivo ed i sottilissimi cavi che lo sostengono e lo alimentano, rendono APOTEMA estremamente etereo e ricco di fascino, contribuendo a valorizzare e rendere immortali i progetti nei quali verrà inserito.

APOTEMA A luminous emotion perfectly in line with the DESIGN LUCE's philosophy. The perfect combination of Italian technology and know-how is the basis of this project which has given rise to this device. With APOTEMA, Design Luce anticipates the future. Its slender silhouette creates a soft atmosphere that enriches the environments in which this excellence of our collection is put.

The particular construction ensures an excellent visual comfort and makes APOTEMA ethereal and full of charm helping to enhance and immortalize the projects in which it will be placed. discreetly every environment. The technical characteristics of STELO ensure the absence of glare and the harmonious integration with natural light.





apotema

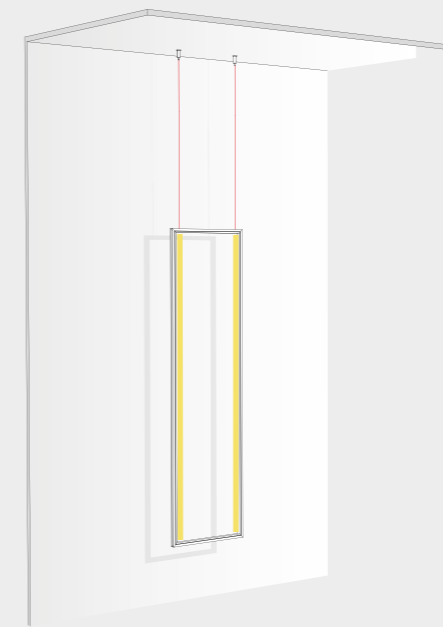
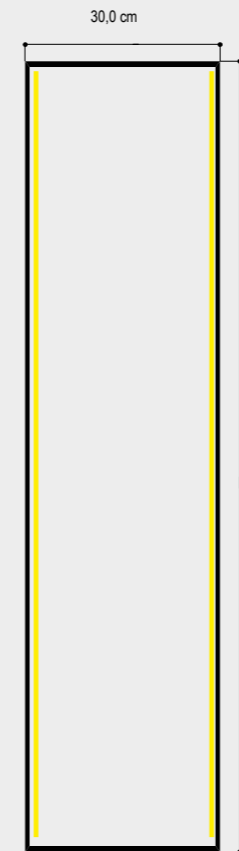
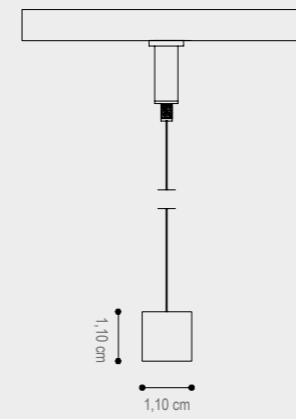

APOTEMA CON DRIVER REMOTO
APOTEMA WITH REMOTE DRIVER

scheda tecnica

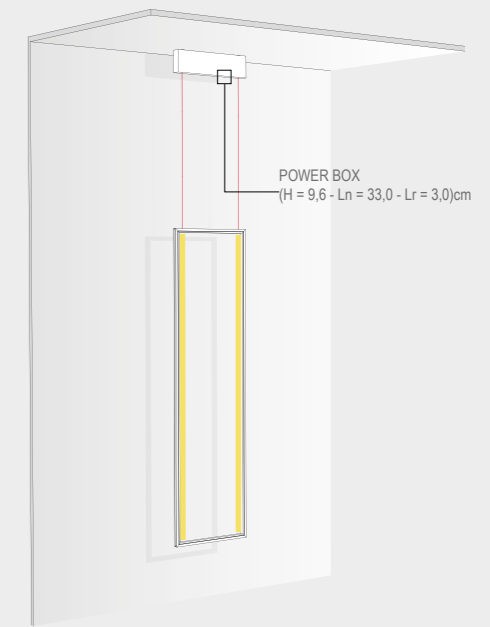

POWER BOX
(H = 9,6 - Ln = 33,0 - Lr = 3,0)cm

APOTEMA CON BOX
APOTEMA WITH POWER SUPPLY BOX

DATI TECNICI
TECHNICAL DATA

30 x 120 cm	
Nominal LED Flux:	3654 lm
Flux Tot:	2923 lm
Output:	105 lm/W
CCT:	3000 K
CRI:	>90
Power Tot:	29.0W
Weight:	1.00 Kg

Profilo/Profile: Alluminio/aluminum Cover: Opale/opal

CAVO ALIMENTAZIONE/SOSPENSIONE: 200 cm
SUSPENSION ALIMENTATION CABLE: 200 cm

APOTEMA 30 x 120 cm
DRIVER ON/OFF INCLUSO

APOTEMA 30 x 120 cm
BOX ON/OFF INCLUSO

APOTEMA 30 x 120 cm
BOX DALI INCLUSO

FINITURA STRUTTURA
FINISHES

ARGILLA CLAY
BIANCO INTONACO/WHITE
NERO CARAVAGGIO/BLACK

CODICE
CODE

10855VA103
10855VB103
10855VN103

CODICE
CODE

10855BA103
10855BB103
10855BN103

CODICE
CODE

10855DA103
10855DB103
10855DN103

IL BOX IN DOTAZIONE È SEMPRE IN FINITURA BIANCO INTONACO. A RICHIESTA SI PUÒ ORDINARE NELLE ALTRE FINITURE A CATALOGO.
THE BOX PROVIDED IS ALWAYS IN PLASTER WHITE FINISH. ON REQUEST YOU CAN HAVE OTHER CATALOG FINISHES.



“accattivante ed estremamente versatile”

DAVINCI è stato disegnato per offrire agli architetti un prodotto flessibile e in linea con i migliori sistemi tecnologici. Il posizionamento dei gruppi ottici contribuiscono a ridurre l'abbagliamento e al recupero dell'efficienza illuminotecnica, rendendolo accattivante ed estremamente versatile. Viene proposto nella versione sospensione con luce diretta/indiretta e a soffitto con luce diretta. Il suo design è decisamente minimale e le sue eleganti finiture gli consentono di essere inserito in tutti gli ambienti architettonici.

DAVINCI has been design to offer a flexible product in line with the best technological systems. The positioning of the optical groups contributes to reduce every glare and recover lighting efficiency, making it attractive and extremely attractive. It's proposed in the suspended version with direct/indirect light and in the ceiling version with direct light. Its design is minimal and its elegant finishes allow it to be put in all architectural environments.



davinci

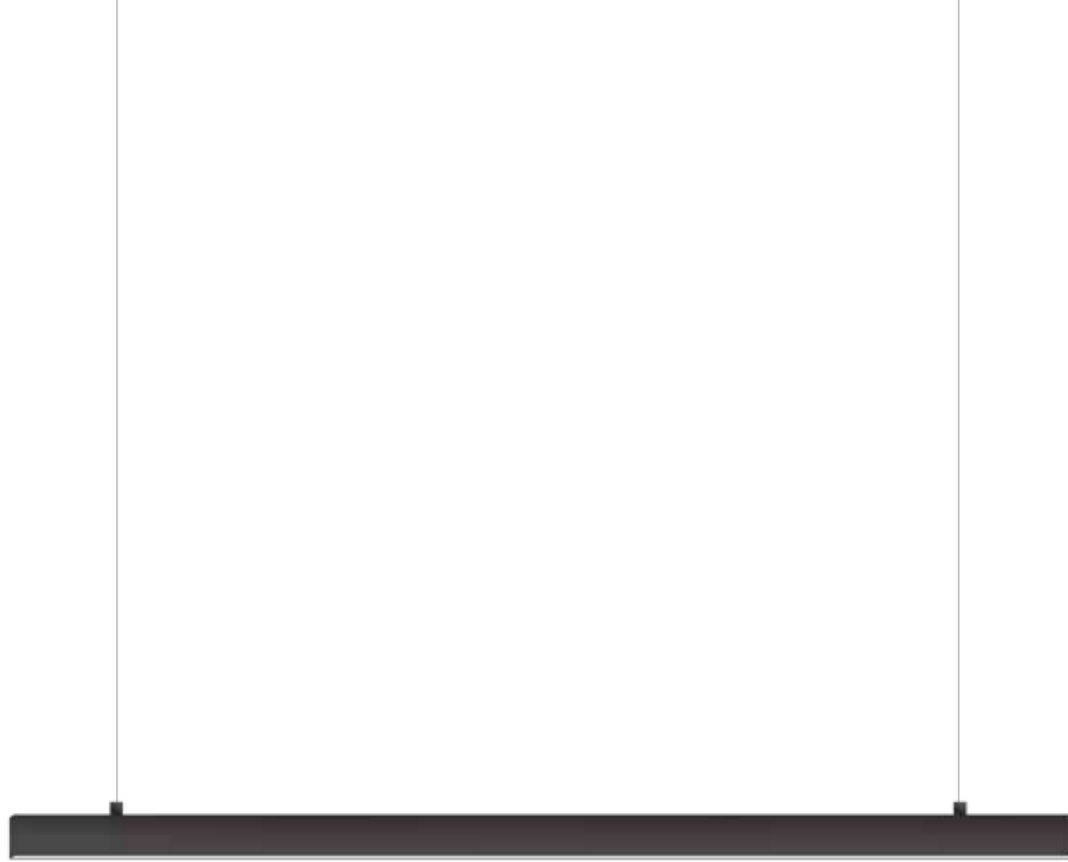

davinci

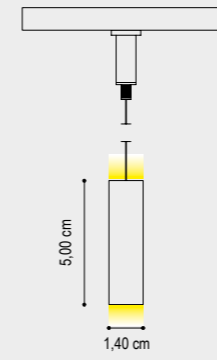

SEZIONE PROFILO/PROFILE SECTION

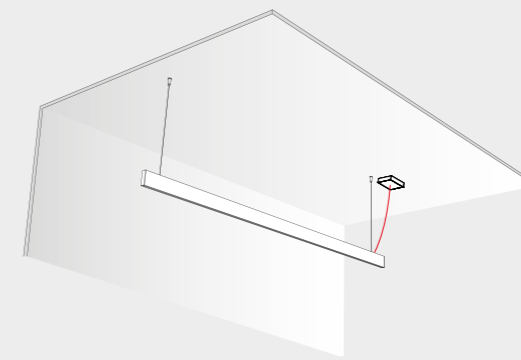

DAVINCI CON DRIVER REMOTO
DAVINCI WITH REMOTE DRIVER

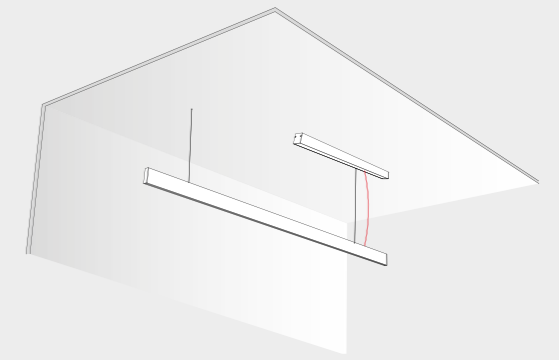

DAVINCI CON BOX
DAVINCI WITH POWER SUPPLY BOX



DRIVER ON/OFF NON INCLUSO/ NOT INCLUDED

ARTICOLI COMPRESI NEL CODICE:
ITEMS INCLUDED IN THE CODE:
CAVO ALIMENTAZIONE TRASPARENTE: 200 cm
TRANSPARENT ALIMENTATION CABLE: 200 cm
CAVI SOSPENSIONE IN ACCIAIO: 200 cm
SUSPENSION CABLES IN STEEL: 200 cm

ATTENZIONE: IL PRODOTTO VIENE GARANTITO
SOLO SE ORDINATI CON I NOSTRI DRIVER
ATTENTION: THE PRODUCT IS GUARANTEED
ONLY IF ORDERED WITH OUR DRIVERS

scheda tecnica

DATI TECNICI
TECHNICAL DATA

	150 cm	200 cm
Nominal LED Flux:	↑2700 lm - 5400 lm ↓	↑3600 lm - 7200 lm ↓
Flux Tot:	↑2160 lm - 4320 lm ↓	↑2880 lm - 5760 lm ↓
Output:	150 lm/W	150 lm/W
CCT:	3000 K	3000 K
CRI:	>90	>90
Power:	↑18.0W - 36.0W ↓	↑24.0W - 48.0W ↓
Power Tot:	54.0W	72.0W
Weight:	1.42 Kg	1.90 Kg

Profilo/Profile: Alluminio/aluminum

Cover: Satinata/satin

150 cm

200 cm

FINITURA STRUTTURA
FINISHES

- GRIGIO VESUVIO ANTHRACITE
- ARGILLA CLAY
- BIANCO INTONACO/WHITE
- NERO CARAVAGGIO BLACK
- CROMO/CHROME
- ORO CALIFORNIA/GOLD
- ARAMEN COPPER
- GRIGIO AVIO GREY AVIO
- ARGENTO COMETA/SILVER COMET
- OTTONE VENEZIANO VENETIAN BRASS
- TITANIO/TITANIUM
- BRONZO RIACI/RIACI BRONZE
- VERDE COSTA/GREEN COAST
- TERRA SENESE SENESE EARTH

COLORE CAVO
WIRE COLOR

- TRASPARENTE
TRANSPARENT
- ACCIAIO
STEEL

	150 cm	200 cm
CODICE 2700K CODE 2700K	405400D150	405400D200
CODICE 3000K CODE 3000K	405500D150	405500D200
CODICE 2700K CODE 2700K	405401D150	405401D200
CODICE 3000K CODE 3000K	405501D150	405501D200
CODICE 2700K CODE 2700K	405403D150	405403D200
CODICE 3000K CODE 3000K	405503D150	405503D200
CODICE 2700K CODE 2700K	405404D150	405404D200
CODICE 3000K CODE 3000K	405504D150	405504D200
CODICE 2700K CODE 2700K	405408D150	405408D200
CODICE 3000K CODE 3000K	405508D150	405508D200
CODICE 2700K CODE 2700K	405409D150	405409D200
CODICE 3000K CODE 3000K	405509D150	405509D200
CODICE 2700K CODE 2700K	405410D150	405410D200
CODICE 3000K CODE 3000K	405510D150	405510D200
CODICE 2700K CODE 2700K	405411D150	405411D200
CODICE 3000K CODE 3000K	405511D150	405511D200
CODICE 2700K CODE 2700K	405412D150	405412D200
CODICE 3000K CODE 3000K	405512D150	405512D200
CODICE 2700K CODE 2700K	405413D150	405413D200
CODICE 3000K CODE 3000K	405513D150	405513D200
CODICE 2700K CODE 2700K	405414D150	405414D200
CODICE 3000K CODE 3000K	405514D150	405514D200
CODICE 2700K CODE 2700K	405415D150	405415D200
CODICE 3000K CODE 3000K	405515D150	405515D200
CODICE 2700K CODE 2700K	405416D150	405416D200
CODICE 3000K CODE 3000K	405516D150	405516D200
CODICE 2700K CODE 2700K	405417D150	405417D200
CODICE 3000K CODE 3000K	405517D150	405517D200

BOX DI ALIMENTAZIONE /
POWER SUPPLY BOX

	60W - ON/OFF	96W - ON/OFF
FINITURA FINISHES	CODICE CODE	CODICE CODE
BIANCO INTONACO/WHITE	403060	403096
NERO CARAVAGGIO BLACK	404060	404096

BOX COPRIMORSETTO /
TERMINAL BOX

FINITURA FINISHES	CODICE CODE
BIANCO INTONACO/WHITE	10403
NERO CARAVAGGIO BLACK	10404



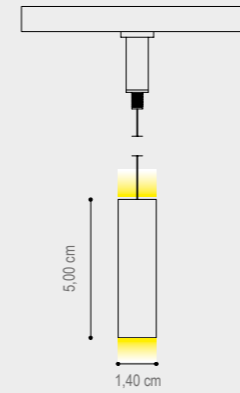

SEZIONE PROFILO/PROFILE SECTION



ARTICOLI COMPRESI NEL CODICE:
 PROFILO CON LED INTEGRATO E DIFFUSORI
 KIT DI SOSPENSIONE (DRIVER NON INCLUSO).
 ITEMS INCLUDED IN THE CODE:
 PROFILE WITH INTEGRATED LED AND SPEAKERS
 SUSPENSION KIT (DRIVER NOT INCLUDED).

ATTENZIONE: IL PRODOTTO VIENE GARANTITO
 SOLO SE ORDINATI CON I NOSTRI DRIVER
 ATTENTION: THE PRODUCT IS GUARANTEED ONLY
 IF ORDERED WITH OUR DRIVERS

CAVO ALIMENTAZIONE TRASPARENTE: 200 cm
 TRANSPARENT ALIMENTATION CABLE: 200 cm
 CAVI SOSPENSIONE IN ACCIAIO: 200 cm
 SUSPENSION CABLES IN STEEL: 200 cm

DATI TECNICI
 TECHNICAL DATA

1 cm - 36W/m	
Nominal LED Flux:	↑ 1800 lm/m - 3600 lm/m ↓
Flux Tot:	↑ 1440 lm/m - 2880 lm/m ↓
Output:	150 lm/W
CCT:	3000 K
CRI:	>90
Power:	↑ 12.0W/m - 24.0W/m ↓
Power Tot:	36.0W/m
Weight:	0.95 Kg/m

Profilo/Profile: Alluminio/aluminum Cover: Satinato/Satin

1 cm - 36W/m

FINITURA STRUTTURA
 FINISHES

- GRIGIO VESUVIO ANTHRACITE
- ARGILLA CLAY
- BIANCO INTONACO/WHITE
- NERO CARAVAGGIO BLACK
- CROMO CHROME
- ORO CALIFORNIA GOLD
- ARAMEN COPPER
- GRIGIO AVIO GREY AVIO
- ARGENTO COMETA/SILVER COMET
- OTTONE VENEZIANO VENETIAN BRASS
- TITANIO/TITANIUM
- BRONZO RIACI/RIACI BRONZE
- VERDE COSTA/GREEN COAST
- TERRA SENESE SENESE EARTH

DIFFUSORE
 DIFFUSER

SATINATA/SATIN

COLORE CAVO
 WIRE COLOR

- TRASPARENTE
TRANSPARENT
- ACCIAIO
STEEL

CODICE 2700K
 CODE 2700K

- 405400D001
- 405401D001
- 405403D001
- 405404D001
- 405408D001
- 405409D001
- 405410D001
- 405411D001
- 405412D001
- 405413D001
- 405414D001
- 405415D001
- 405416D001
- 405417D001

CODICE 3000K
 CODE 3000K

- 405500D001
- 405501D001
- 405503D001
- 405504D001
- 405508D001
- 405509D001
- 405510D001
- 405511D001
- 405512D001
- 405513D001
- 405514D001
- 405515D001
- 405516D001
- 405517D001

TESTATE DI CHIUSURA / DEAD ENDS



FINITURA STRUTTURA
 FINISHES

- GRIGIO VESUVIO ANTHRACITE
- ARGILLA CLAY
- BIANCO INTONACO/WHITE
- NERO CARAVAGGIO BLACK
- CROMO CHROME
- ORO CALIFORNIA GOLD
- ARAMEN COPPER

CODICE
 CODE

- 400400
- 400401
- 400403
- 400404
- 400408
- 400409
- 400410

FINITURA STRUTTURA
 FINISHES

- GRIGIO AVIO GREY AVIO
- ARGENTO COMETA/SILVER COMET
- OTTONE VENEZIANO VENETIAN BRASS
- TITANIO/TITANIUM
- BRONZO RIACI/RIACI BRONZE
- VERDE COSTA/GREEN COAST
- TERRA SENESE SENESE EARTH

CODICE
 CODE

- 400411
- 400412
- 400413
- 400414
- 400415
- 400416
- 400417

Nel codice sono comprese le viti per il fissaggio delle testate al profilo. Il codice contiene n° 1 testate di chiusura.
 The code includes the screws for fixing the heads to the profile. The code contains 1 closing warheads

BOX DI ALIMENTAZIONE / POWER SUPPLY BOX



FINITURA FINISHES	96W - ON/OFF (Ln 325 x Lr 75 x H 25) mm	120W - ON/OFF (Ln 374 x Lr 77 x H 35) mm	100W - DALI PUSH (Ln 374 x Lr 77 x H 35) mm	150W - DALI PUSH (Ln 374 x Lr 77 x H 35) mm
	CODICE CODE	CODICE CODE	CODICE CODE	CODICE CODE
BIANCO INTONACO/WHITE	10403096	10403120	10403100	10403150
NERO CARAVAGGIO BLACK	10404096	10404120	10404100	10404150



“migliori standard illuminotecnici”

MICHELANGELO è un progetto talentuoso realizzato grazie alla continua ricerca del design e al saper fare della nostra azienda. Adotta i migliori sistemi tecnologici disponibili in materia di salvaguardia dell'ambiente. Infatti, il particolare posizionamento dei gruppi ottici concepiti per recuperare i flussi luminosi e ridurre l'abbagliamento gli consentono di raggiungere i migliori standard illuminotecnici. Disegnato per garantire ai progettisti un prodotto minimale con un accentuato senso decorativo la varietà delle finiture lo rendendolo accattivante ed estremamente versatile al punto da consentire ai lighting designer di adottarlo in tutti gli spazi architettonici, siano essi moderni, classici, luxury che futuristici.

MICHELANGELO is a talented project created thanks to the continuous research and know-how of our company. It has got the best technological system available for the environment: the particular positioning of the optical groups has been designed to recover the luminous flux and reduce glare; this allows MICHELANGELO to reach the best lighting standards.

It's a minimal product with a high decorative sense, the many finishes make it attractive and extremely versatile to the point of allowing designers to adopt it in all architectural spaces, whether modern, classic, luxury or futuristic.



michelangelo

scheda tecnica

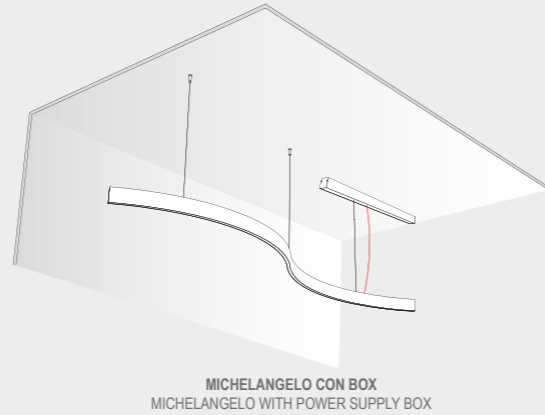
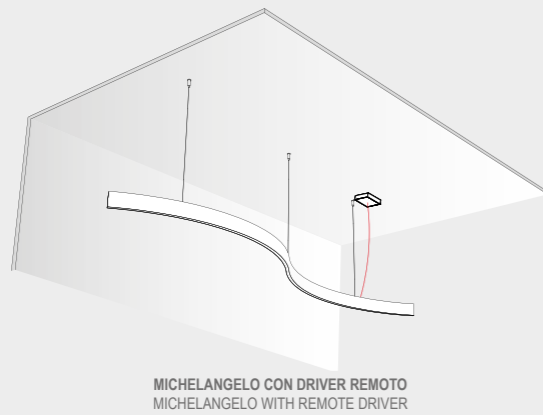
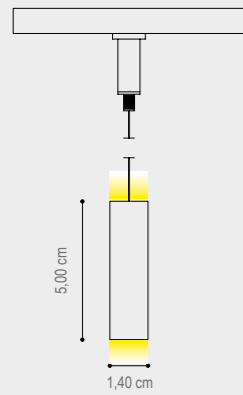

SEZIONE PROFILO/PROFILE SECTION

MICHELANGELO CON DRIVER REMOTO
MICHELANGELO WITH REMOTE DRIVER

MICHELANGELO CON BOX
MICHELANGELO WITH POWER SUPPLY BOX



DRIVER 24V ON/OFF INCLUSO
PER INSTALLAZIONE IN REMOTO
DRIVER 24V ON/OFF INCLUDED
FOR REMOTE INSTALLATION

CAVO ALIMENTAZIONE TRASPARENTE: 200 cm
TRANSPARENT ALIMENTATION CABLE: 200 cm
CAVI SOSPENSIONE IN ACCIAIO: 200 cm
SUSPENSION CABLES IN STEEL: 200 cm

ATTENZIONE: IL PRODOTTO VIENE GARANTITO
SOLO SE ORDINATI CON I NOSTRI DRIVER
ATTENTION: THE PRODUCT IS GUARANTEED
ONLY IF ORDERED WITH OUR DRIVERS

DATI TECNICI
TECHNICAL DATA

	150 cm	200 cm
Nominal LED Flux:	↑3318 lm - 6636 lm ↓	↑4108 lm - 8374 lm ↓
Flux Tot:	↑2654 lm - 5309 lm ↓	↑3286 lm - 6700 lm ↓
Output:	150 lm/W	150 lm/W
CCT:	3000 K	3000 K
CRI:	>90	>90
Power:	↑21.0W - 42.0W ↓	↑26.0W - 53.0W ↓
Power Tot:	63.0W	79.0W
Weight:	1.42 Kg	1.90 Kg

Profilo/Profile: Alluminio/aluminum

Cover: Satinato/Satin

150 cm

200 cm

FINITURA STRUTTURA
FINISHES

- GRIGIO VESUVIO ANTHRACITE
- ARGILLA CLAY
- BIANCO INTONACO/WHITE
- NERO CARAVAGGIO BLACK
- CROMO CHROME
- ORO CALIFORNIA GOLD
- ARAMEN COPPER
- GRIGIO AVIO GREY AVIO
- ARGENTO COMETA/SILVER COMET
- OTTONE VENEZIANO VENETIAN BRASS
- TITANIO/TITANIUM
- BRONZO RIACI/RIACI BRONZE
- VERDE COSTA/GREEN COAST
- TERRA SENESE SENESE EARTH

COLORE CAVO
WIRE COLOR

- TRASPARENTE
TRANSPARENT
- ACCIAIO
STEEL

	150 cm		200 cm	
	CODICE 2700K CODE 2700K	CODICE 3000K CODE 3000K	CODICE 2700K CODE 2700K	CODICE 3000K CODE 3000K
405400M150	405500M150	405400M200	405500M200	
405401M150	405501M150	405401M200	405501M200	
405403M150	405503M150	405403M200	405503M200	
405404M150	405504M150	405404M200	405504M200	
405408M150	405508M150	405408M200	405508M200	
405409M150	405509M150	405409M200	405509M200	
405410M150	405510M150	405410M200	405510M200	
405411M150	405511M150	405411M200	405511M200	
405412M150	405512M150	405412M200	405512M200	
405413M150	405513M150	405413M200	405513M200	
405414M150	405514M150	405414M200	405514M200	
405415M150	405515M150	405415M200	405515M200	
405416M150	405516M150	405416M200	405516M200	
405417M150	405517M150	405417M200	405517M200	

BOX DI ALIMENTAZIONE / POWER SUPPLY BOX



FINITURA FINISHES	96W - ON/OFF (Ln 325 x Lr 75 x H 25) mm	120W - ON/OFF (Ln 374 x Lr 77 x H 35) mm	100W - DALI PUSH (Ln 374 x Lr 77 x H 35) mm	150W - DALI PUSH (Ln 374 x Lr 77 x H 35) mm
	CODICE CODE	CODICE CODE	CODICE CODE	CODICE CODE
BIANCO INTONACO/WHITE	10403096	10403120	10403100	10403150
NERO CARAVAGGIO BLACK	10404096	10404120	10404100	10404150



michelangelo

custom

scheda tecnica

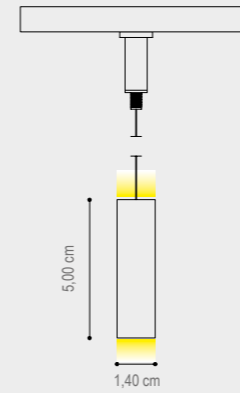

ATTENZIONE!
LUNGHEZZA MINIMA ORDINABILE: 100 cm
LUNGHEZZA MASSIMA: 300 cm
WARNING!
MINIMUM ORDERING LENGTH: 100 cm
MAXIMUM LENGTH: 300 cm
ARTICOLI COMPRESI NEL CODICE:
PROFILO CON LED INTEGRATO E DIFFUSORI
KIT DI SOSPENSIONE (DRIVER NON INCLUSO).
ITEMS INCLUDED IN THE CODE:
PROFILE WITH INTEGRATED LED AND SPEAKERS
SUSPENSION KIT (DRIVER NOT INCLUDED).
CAVO ALIMENTAZIONE TRASPARENTE: 200 cm
TRANSPARENT ALIMENTATION CABLE: 200 cm
CAVI SOSPENSIONE IN ACCIAIO: 200 cm
SUSPENSION CABLES IN STEEL: 200 cm

SEZIONE PROFILO/PROFILE SECTION

DATI TECNICI
TECHNICAL DATA

	1 cm - 36W/m
Nominal LED Flux:	↑1900 lm/m - 3800 lm/m ↓
Flux Tot:	↑1520 lm/m - 3040 lm/m ↓
Output:	150 lm/W
CCT:	3000 K
CRI:	>90
Power:	↑12.0W/m - 24.0W/m ↓
Power Tot:	36.0W/m
Weight:	0.95 Kg/m

Profilo/Profile: Alluminio/aluminum

Cover: Opale/opal - Satinato/Satin

1 cm - 36W/m

FINITURA STRUTTURA
FINISHES

- GRIGIO VESUVIO ANTHRACITE
- ARGILLA CLAY
- BIANCO INTONACO/WHITE
- NERO CARAVAGGIO BLACK
- CROMO CHROME
- ORO CALIFORNIA GOLD
- ARAMEN COPPER
- GRIGIO AVIO GREY AVIO
- ARGENTO COMETA/SILVER COMET
- OTTONE VENEZIANO VENETIAN BRASS
- TITANIO/TITANIUM
- BRONZO RIACI/RIACI BRONZE
- VERDE COSTA/GREEN COAST
- TERRA SENESE SENESE EARTH

DIFFUSORE
DIFFUSER

- SATINATA/SATIN

COLORE CAVO
WIRE COLOR

- TRASPARENTE
TRANSPARENT
- ACCIAIO
STEEL

CODICE 2700K
CODE 2700K

- 405400M001
- 405401M001
- 405403M001
- 405404M001
- 405408M001
- 405409M001
- 405410M001
- 405411M001
- 405412M001
- 405413M001
- 405414M001
- 405415M001
- 405416M001
- 405417M001

CODICE 3000K
CODE 3000K

- 405500M001
- 405501M001
- 405503M001
- 405504M001
- 405508M001
- 405509M001
- 405510M001
- 405511M001
- 405512M001
- 405513M001
- 405514M001
- 405515M001
- 405516M001
- 405517M001

TESTATE DI CHIUSURA / DEAD ENDS



FINITURA STRUTTURA
FINISHES

- GRIGIO VESUVIO ANTHRACITE
- ARGILLA CLAY
- BIANCO INTONACO/WHITE
- NERO CARAVAGGIO BLACK
- CROMO CHROME
- ORO CALIFORNIA GOLD
- ARAMEN COPPER

CODICE
CODE

- 400400
- 400401
- 400403
- 400404
- 400408
- 400409
- 400410

FINITURA STRUTTURA
FINISHES

- GRIGIO AVIO GREY AVIO
- ARGENTO COMETA/SILVER COMET
- OTTONE VENEZIANO VENETIAN BRASS
- TITANIO/TITANIUM
- BRONZO RIACI/RIACI BRONZE
- VERDE COSTA/GREEN COAST
- TERRA SENESE SENESE EARTH

CODICE
CODE

- 400411
- 400412
- 400413
- 400414
- 400415
- 400416
- 400417

Nel codice sono comprese le viti per il fissaggio delle testate al profilo. Il codice contiene n° 1 testate di chiusura.
The code includes the screws for fixing the heads to the profile. The code contains 1 closing warheads

BOX DI ALIMENTAZIONE / POWER SUPPLY BOX



FINITURA FINISHES	96W - ON/OFF (Ln 325 x Lr 75 x H 25) mm	120W - ON/OFF (Ln 374 x Lr 77 x H 35) mm	100W - DALI PUSH (Ln 374 x Lr 77 x H 35) mm	150W - DALI PUSH (Ln 374 x Lr 77 x H 35) mm
	CODICE CODE	CODICE CODE	CODICE CODE	CODICE CODE
BIANCO INTONACO/WHITE	10403096	10403120	10403100	10403150
NERO CARAVAGGIO BLACK	10404096	10404120	10404100	10404150



“essenziale, tecnico e creativo”

Il progetto DALÌ vuole essere essenziale e creativo, tecnico e allo stesso tempo decorativo. La sua sobria e spiccata eleganza si inserisce in tutti gli ambienti senza disturbarne l'architettura, anzi, valorizzandola. La sua forma elegante non trascura gli standard d'illuminazioni più elevati in termini di efficienza e risparmio energetico, temi così attuali oggi nell'opinione pubblica mondiale. Disponibile nella versione luce diretta e indiretta, può essere equipaggiata con alimentazioni on-off o dimmer.

The DALÌ project aims to be essential and creative, technical and decorative at the same time. It's sober elegance fits into all environments without disturbing the architecture, indeed, enhancing it. Dali does not overlook the highest lighting standards: efficiency and energy saving. It's available in the direct and direct and indirect version with on-off or dimmer supplies.

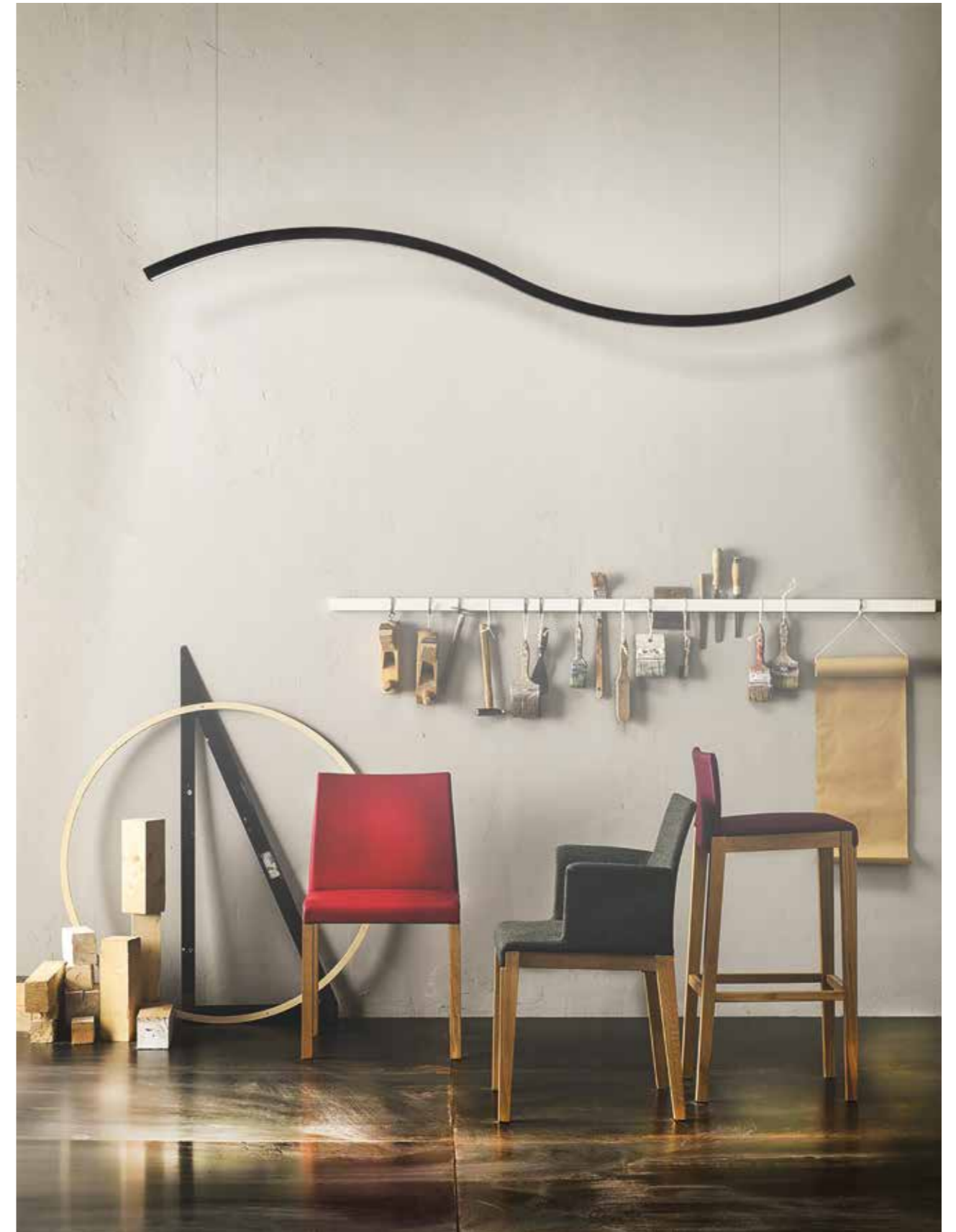

dali

scheda tecnica

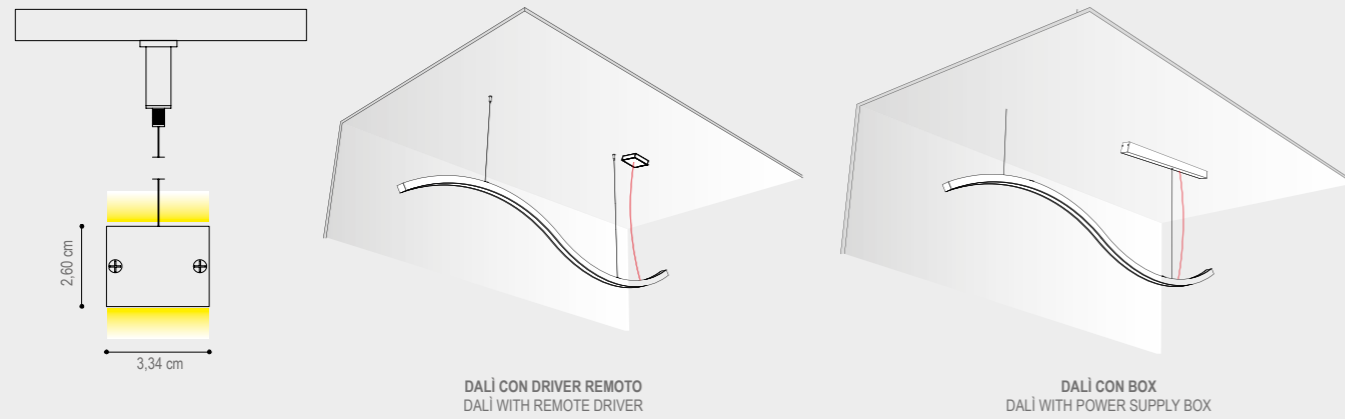

SEZIONE PROFILO/PROFILE SECTION



DATI TECNICI
TECHNICAL DATA

	150 cm	200 cm
Nominal LED Flux:	↑ 3717 lm - 3717 lm ↓	↑ 4620 lm - 4620 lm ↓
Flux Tot:	↑ 2974 lm - 2974 lm ↓	↑ 3696 lm - 3696 lm ↓
Output:	110 lm/W	110 lm/W
CCT:	3000 K	3000 K
CRI:	>95	>95
Power:	↑ 34.0W - 34.0W ↓	↑ 42.0W - 42.0W ↓
Power Tot:	68.0W	84.0W
Weight:	1.95 Kg	2.70 Kg

Profilo/Profile: Alluminio/aluminum

Cover: Opale/opal

BOX ON/OFF INCLUSO/INCLUDED

CAVO ALIMENTAZIONE TRASPARENTE: 200 cm / TRASPARENT ALIMENTATION CABLE: 200 cm
CAVI SOSPENSIONE IN ACCIAIO: 200 cm / SUSPENSION CABLES IN STEEL: 200 cm

150 cm

200 cm

FINITURA STRUTTURA FINISHES	COLORE CAVO WIRE COLOR	CODICE 2700K CODE 2700K	CODICE 3000K CODE 3000K	CODICE 2700K CODE 2700K	CODICE 3000K CODE 3000K
GRIGIO VESUVIO ANTHRACITE	TRASPARENTE TRANSPARENT	422500S150	422600S150	422500S200	422600S200
ARGILLA CLAY		422501S150	422601S150	422501S200	422601S200
BIANCO INTONACO/WHITE		422503S150	422603S150	422503S200	422603S200
NERO CARAVAGGIO BLACK		422504S150	422604S150	422504S200	422604S200
CROMO CHROME		422508S150	422608S150	422508S200	422608S200
ORO CALIFORNIA/GOLD		422509S150	422609S150	422509S200	422609S200
ARAMEN COPPER		422510S150	422610S150	422510S200	422610S200
GRIGIO AVIO GREY AVIO		422511S150	422611S150	422511S200	422611S200
ARGENTO COMETA/SILVER COMET		422512S150	422612S150	422512S200	422612S200
OTTONE VENEZIANO/VENETIAN BRASS		422513S150	422613S150	422513S200	422613S200
TITANIO/TITANIUM		422514S150	422614S150	422514S200	422614S200
BRONZO RIACI/RIACI BRONZE		422515S150	422615S150	422515S200	422615S200
VERDE COSTA/GREEN COAST		422516S150	422616S150	422516S200	422616S200
TERRA SENESE SENESE EARTH	422517S150	422617S150	422517S200	422617S200	

TRASPARENTE
TRANSPARENT

ACCIAIO
STEEL

dali

scheda tecnica

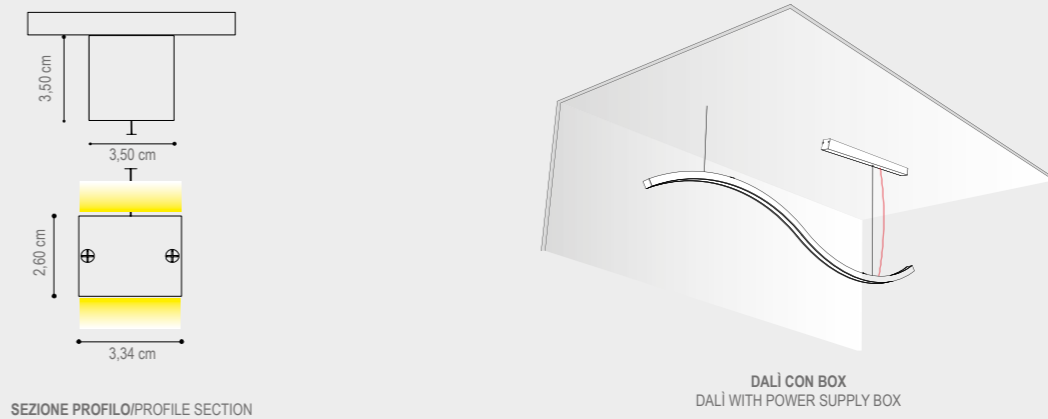

SEZIONE PROFILO/PROFILE SECTION



DATI TECNICI
TECHNICAL DATA

	150 cm	200 cm	300 cm
Nominal LED Flux:	↑ 3717 lm - 3717 lm ↓	↑ 4620 lm - 4620 lm ↓	↑ 6594 lm - 6594 lm ↓
Flux Tot:	↑ 2974 lm - 2974 lm ↓	↑ 3696 lm - 3696 lm ↓	↑ 5275 lm - 5275 lm ↓
Output:	110 lm/W	110 lm/W	110 lm/W
CCT:	3000 K	3000 K	3000 K
CRI:	>95	>95	>95
Power:	↑ 34.0W - 34.0W ↓	↑ 42.0W - 42.0W ↓	↑ 60.0W - 60.0W ↓
Power Tot:	68.0W	84.0W	120.0W
Weight:	1.95 Kg	2.70 Kg	3.50 Kg

Profilo/Profile: Alluminio/aluminum

Cover: Opale/opal Opale/opal

BOX DALI - PUSH INCLUSO
BOX DALI - PUSH INCLUDED

CAVO ALIMENTAZIONE TRASPARENTE: 200 cm / TRASPARENT ALIMENTATION CABLE: 200 cm
CAVI SOSPENSIONE IN ACCIAIO: 200 cm / SUSPENSION CABLES IN STEEL: 200 cm

150 cm

200 cm

FINITURA STRUTTURA FINISHES	COLORE CAVO WIRE COLOR	CODICE CODE	CODICE CODE
GRIGIO VESUVIO ANTHRACITE	TRASPARENTE TRANSPARENT	422600Y150	422600Y200
ARGILLA CLAY		422601Y150	422601Y200
BIANCO INTONACO/WHITE		422603Y150	422603Y200
NERO CARAVAGGIO BLACK		422604Y150	422604Y200
ORO CALIFORNIA/GOLD		422609Y150	422609Y200
ARAMEN COPPER		422610Y150	422610Y200
GRIGIO AVIO GREY AVIO		422611Y150	422611Y200
ARGENTO COMETA/SILVER COMET		422612Y150	422612Y200
OTTONE VENEZIANO/VENETIAN BRASS		422613Y150	422613Y200
TITANIO/TITANIUM		422614Y150	422614Y200
BRONZO RIACI/RIACI BRONZE		422615Y150	422615Y200
VERDE COSTA/GREEN COAST		422616Y150	422616Y200
TERRA SENESE SENESE EARTH		422617Y150	422617Y200
CROMO CHROME	422608Y150	422608Y200	

TRASPARENTE
TRANSPARENT

ACCIAIO
STEEL

“essenziale, tecnico e creativo”

Quando abbiamo pensato a questa lampada volevamo offrire un prodotto in grado di assolvere ad una varietà di funzioni, proprio come le costellazioni la cui meraviglia ha ispirato l'uomo fin dalla mitologia. La sua forma circolare ottenuta tramite due semisfere in alluminio e policarbonato, abbinato allo snodo che consente la rotazione dei bracci sugli assi orizzontali e verticali, le sorgenti luminose a LED, rendono questo progetto estremamente futuristico

When we thought about this lamp we wanted to offer a product capable of performing a variety of functions, just like the constellations whose wonder has inspired man since mythology. Its circular shape obtained through two aluminum and polycarbonate hemispheres, combined with the joint that allows the rotation of the arms on the horizontal and vertical axes, the LED light sources make this project extremely futuristic.



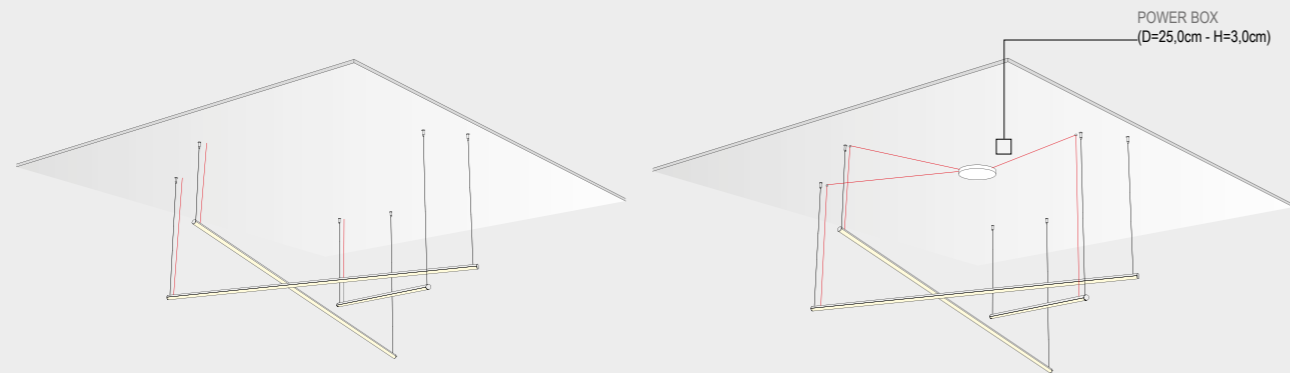
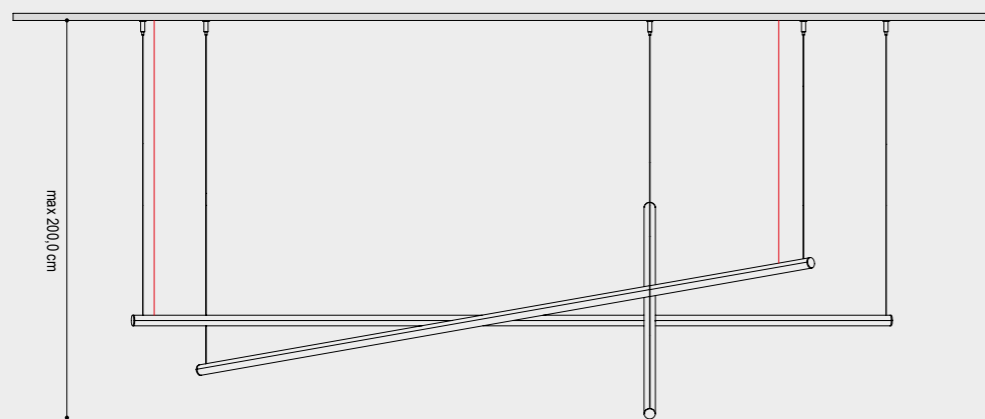
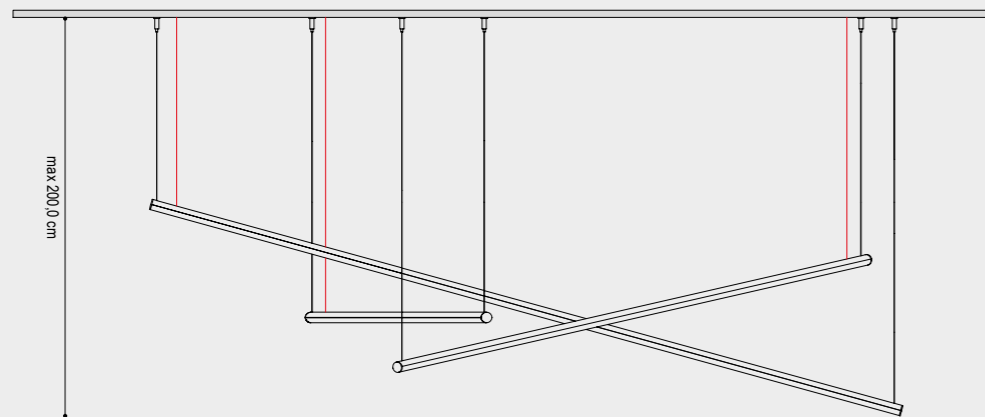

COSTELLAZIONE CON DRIVER REMOTO
COSTELLAZIONE WITH REMOTE DRIVER

COSTELLAZIONE CON BOX
COSTELLAZIONE WITH POWER SUPPLY BOX

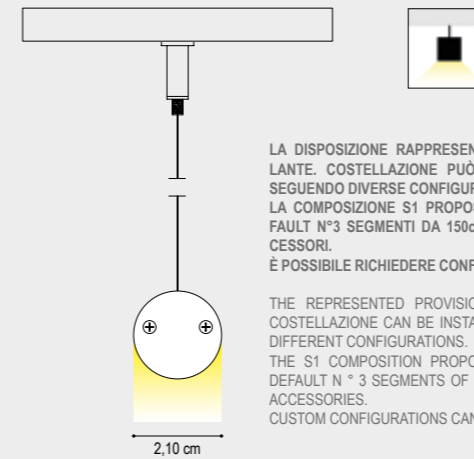

LA DISPOSIZIONE RAPPRESENTATA NON È VINCOLANTE. COSTELLAZIONE PUÒ ESSERE ORDINATO SEGUENDO DIVERSE CONFIGURAZIONI. LA COMPOSIZIONE S1 PROPOSTA PREVEDE DI DEFAULT N°3 SEGMENTI DA 150cm CON RELATIVI ACCESSORI. È POSSIBILE RICHIEDERE CONFIGURAZIONI CUSTOM.

THE REPRESENTED PROVISION IS NOT BINDING. COSTELLAZIONE CAN BE INSTALLED BY FOLLOWING DIFFERENT CONFIGURATIONS. THE S1 COMPOSITION PROPOSED PROVIDES FOR DEFAULT N° 3 SEGMENTS OF 150cm WITH RELATED ACCESSORIES. CUSTOM CONFIGURATIONS CAN BE REQUESTED.

SEZIONE PROFILO/PROFILE SECTION

DRIVER 24V ON/OFF NON INCLUSO/ NOT INCLUDED DRIVER 24V

CAVO ALIMENTAZIONE TRASPARENTE: 200 cm
TRANSPARENT ALIMENTATION CABLE: 200 cm
CAVI SOSPENSIONE IN ACCIAIO: 200 cm
SUSPENSION CABLES IN STEEL: 200 cm

ATTENZIONE: IL PRODOTTO VIENE GARANTITO SOLO SE ORDINATI CON I NOSTRI DRIVER
ATTENTION: THE PRODUCT IS GUARANTEED ONLY IF ORDERED WITH OUR DRIVERS

FINITURA STRUTTURA
FINISHES

- GRIGIO VESUVIO ANTHRACITE
- ARGILLA CLAY
- BIANCO INTONACO/WHITE
- NERO CARAVAGGIO BLACK
- CROMO/CHROME
- ORO CALIFORNIA/GOLD
- ARAMEN COPPER
- GRIGIO AVIO/ GREY AVIO
- ARGENTO COMETA/SILVER COMET
- OTTONE VENEZIANO/ VENETIAN BRASS
- TITANIO/TITANIUM
- BRONZO RIACI/RIACI BRONZE
- VERDE COSTA/GREEN COAST
- TERRA SENESE/SENESE EARTH

COLORE CAVO
WIRE COLOR

- TRASPARENTE
TRANSPARENT
- ACCIAIO
STEEL

DATI TECNICI
TECHNICAL DATA

COMPOSIZIONE S1 (3x150cm)	
Nominal LED Flux:	3300 lm + 3300 lm + 3300 lm
Flux Tot:	2640 lm + 2640 lm + 2640 lm
Output:	110 lm/W
CCT:	3000 K
CRI:	>95
Power:	30.0W + 30.0W + 30.0W
Power Tot:	90.0W
Weight:	4.50 Kg
Profilo/Profile:	Alluminio/aluminum
Cover:	Opale/opal

COMPOSIZIONE S1 (3x150cm)

CODICE 2700K CODE 2700K	CODICE 3000K CODE 3000K
1325S100	1326S100
1325S101	1326S101
1325S103	1326S103
1325S104	1326S104
1325S108	1326S108
1325S109	1326S109
1325S110	1326S110
1325S111	1326S111
1325S112	1326S112
1325S113	1326S113
1325S114	1326S114
1325S115	1326S115
1325S116	1326S116
1325S117	1326S117

BOX DI ALIMENTAZIONE CON FORI RADIALI /
POWER SUPPLY BOX WITH RADIAL HOLES

FINITURA STRUTTURA FINISHES	TIPOLOGIA TYPE	60W	96W	120W (2x60W)	192W (2x96W)
		CODICE CODE	CODICE CODE	CODICE CODE	CODICE CODE
BIANCO INTONACO/WHITE	ON/OFF	T03060	T03096	T03120	T03192
	DALI	D03060	D03096	D03120	D03192

N.B.: VERSIONE 120W E 192W CONFIGURATI PER DOPPIA ACCENSIONE
/ PLEASE NOTE: 120W AND 192W VERSION CONFIGURED FOR DOUBLE IGNITION



“estremamente accattivante”

La costante ricerca di forme e soluzioni tecniche innovative ci ha portato a sviluppare la nuova sospensione SFERETTA. La sua sezione rotonda le conferisce un carattere estremamente accattivante e moderno. Le ottiche attive disegnate al suo interno, i diffusori arretrati in policarbonato, i LED di ultima generazione, i cavi in tessuto, fanno di SFERETTA un oggetto d'arredo da inserire in tutti gli ambienti dove l'architetto richiede sistemi di illuminazione con alte prestazioni e nei quali la luce dovrà integrarsi totalmente nell'ambiente.

The constant search for innovative shapes and technical solutions led us to develop the new SFERETTA suspension. Its round section gives it an extremely captivating and modern character. The active optics designed inside, the rearward polycarbonate diffusers, the latest generation LEDs, the fabric cables, make SFERETTA a piece of furniture to be inserted in all environments where the architect requires high performance lighting systems and in which the light will have to be totally integrated into the environment.



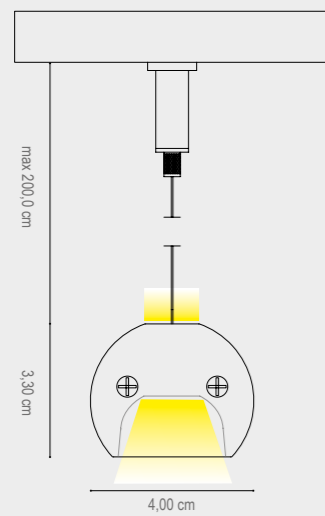
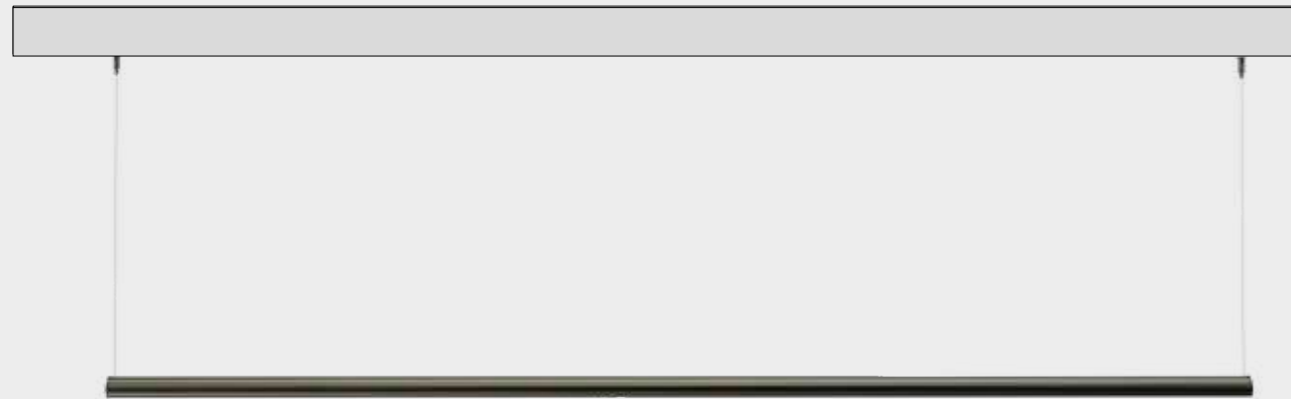

LA SOSPENSIONE SFERETTA PREVEDE L'INSTALLAZIONE DELL'OTTICA ARRETRATA
THE SFERETTA SUSPENSION PROVIDES THE INSTALLATION OF THE BACKGROUND OPTICS

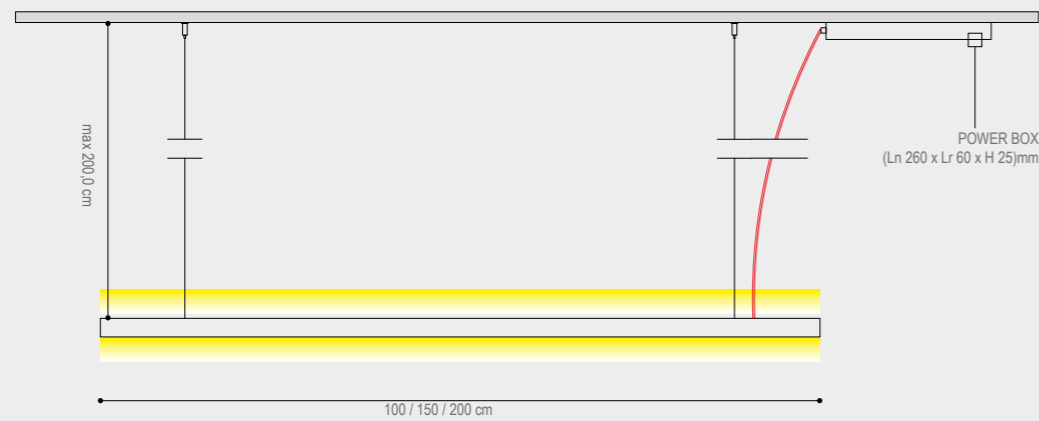

BOX ON/OFF INCLUSO / INCLUDED

IL BOX IN DOTAZIONE È SEMPRE IN FINITURA BIANCO INTONACO. A RICHIESTA SI PUÒ ORDINARE NELLE ALTRE FINITURE A CATALOGO. THE BOX PROVIDED IS ALWAYS IN PLASTER WHITE FINISH. ON REQUEST YOU CAN HAVE OTHER CATALOG FINISHES.

CAVO ALIMENTAZIONE: 200 cm
ALIMENTATION CABLE: 200 cm
CAVI SOSPENSIONE IN ACCIAIO: 200 cm
SUSPENSION CABLES IN STEEL: 200 cm

DATI TECNICI
TECHNICAL DATA

	100 cm	150 cm	200 cm
Nominal LED Flux:	↑ 2200 lm - 2200 lm ↓	↑ 3300 lm - 3300 lm ↓	↑ 4400 lm - 4400 lm ↓
Flux Tot:	↑ 1760 lm - 1760 lm ↓	↑ 2640 lm - 2640 lm ↓	↑ 3520 lm - 3520 lm ↓
Output:	110 lm/W	110 lm/W	110 lm/W
CCT:	3000 K	3000 K	3000 K
CRI:	>90	>90	>90
Power:	↑ 20.0W - 20.0W ↓	↑ 30.0W - 30.0W ↓	↑ 40.0W - 40.0W ↓
Power Tot:	40.0W	60.0W	80.0W
Weight:	1.90 Kg	2.30 Kg	3.80 Kg

Profilo/Profile: Alluminio/aluminum

Cover: Opale-satinata/opal-satin

FINITURA STRUTTURA FINISHES	COLORE CAVO WIRE COLOR	100 cm CODICE CODE	150 cm CODICE CODE	200 cm CODICE CODE
ARGILLA CLAY	BIANCO/WHITE	2040B01003	2060B01003	2080B01003
	NERO/BLACK	2040N01003	2060N01003	2080N01003
	BORDEAUX BORDEAUX	2040D01003	2060D01003	2080D01003
	TRASPARENTE/TRANSPARENT	2040T01003	2060T01003	2080T01003
BIANCO INTONACO/WHITE	BIANCO/WHITE	2040B30003	2060B30003	2080B30003
	NERO/BLACK	2040N30003	2060N30003	2080N30003
	BORDEAUX BORDEAUX	2040D30003	2060D30003	2080D30003
	TRASPARENTE/TRANSPARENT	2040T30003	2060T30003	2080T30003
NERO CARAVAGGIO/BLACK	BIANCO/WHITE	2040B40003	2060B40003	2080B40003
	NERO/BLACK	2040N40003	2060N40003	2080N40003
	BORDEAUX BORDEAUX	2040D40003	2060D40003	2080D40003
	TRASPARENTE/TRANSPARENT	2040T40003	2060T40003	2080T40003
MOKA MOCHA	BIANCO/WHITE	2040B05003	2060B05003	2080B05003
	NERO/BLACK	2040N05003	2060N05003	2080N05003
	BORDEAUX BORDEAUX	2040D05003	2060D05003	2080D05003
	TRASPARENTE/TRANSPARENT	2040T05003	2060T05003	2080T05003
CROMO/CHROME	BIANCO/WHITE	2040B08003	2060B08003	2080B08003
	NERO/BLACK	2040N08003	2060N08003	2080N08003
	BORDEAUX BORDEAUX	2040D08003	2060D08003	2080D08003
	TRASPARENTE/TRANSPARENT	2040T08003	2060T08003	2080T08003
ORO CALIFORNIA/GOLD	BIANCO/WHITE	2040B09003	2060B09003	2080B09003
	NERO/BLACK	2040N09003	2060N09003	2080N09003
	BORDEAUX BORDEAUX	2040D09003	2060D09003	2080D09003
	TRASPARENTE/TRANSPARENT	2040T09003	2060T09003	2080T09003
ARAMEN COPPER	BIANCO/WHITE	2040B10003	2060B10003	2080B10003
	NERO/BLACK	2040N10003	2060N10003	2080N10003
	BORDEAUX BORDEAUX	2040D10003	2060D10003	2080D10003
	TRASPARENTE/TRANSPARENT	2040T10003	2060T10003	2080T10003
ARGENTO COMETA/SILVER COMET	BIANCO/WHITE	2040B12003	2060B12003	2080B12003
	NERO/BLACK	2040N12003	2060N12003	2080N12003
	BORDEAUX BORDEAUX	2040D12003	2060D12003	2080D12003
	TRASPARENTE/TRANSPARENT	2040T12003	2060T12003	2080T12003
OTTONE VENEZIANO/BRASS	BIANCO/WHITE	2040B13003	2060B13003	2080B13003
	NERO/BLACK	2040N13003	2060N13003	2080N13003
	BORDEAUX BORDEAUX	2040D13003	2060D13003	2080D13003
	TRASPARENTE/TRANSPARENT	2040T13003	2060T13003	2080T13003



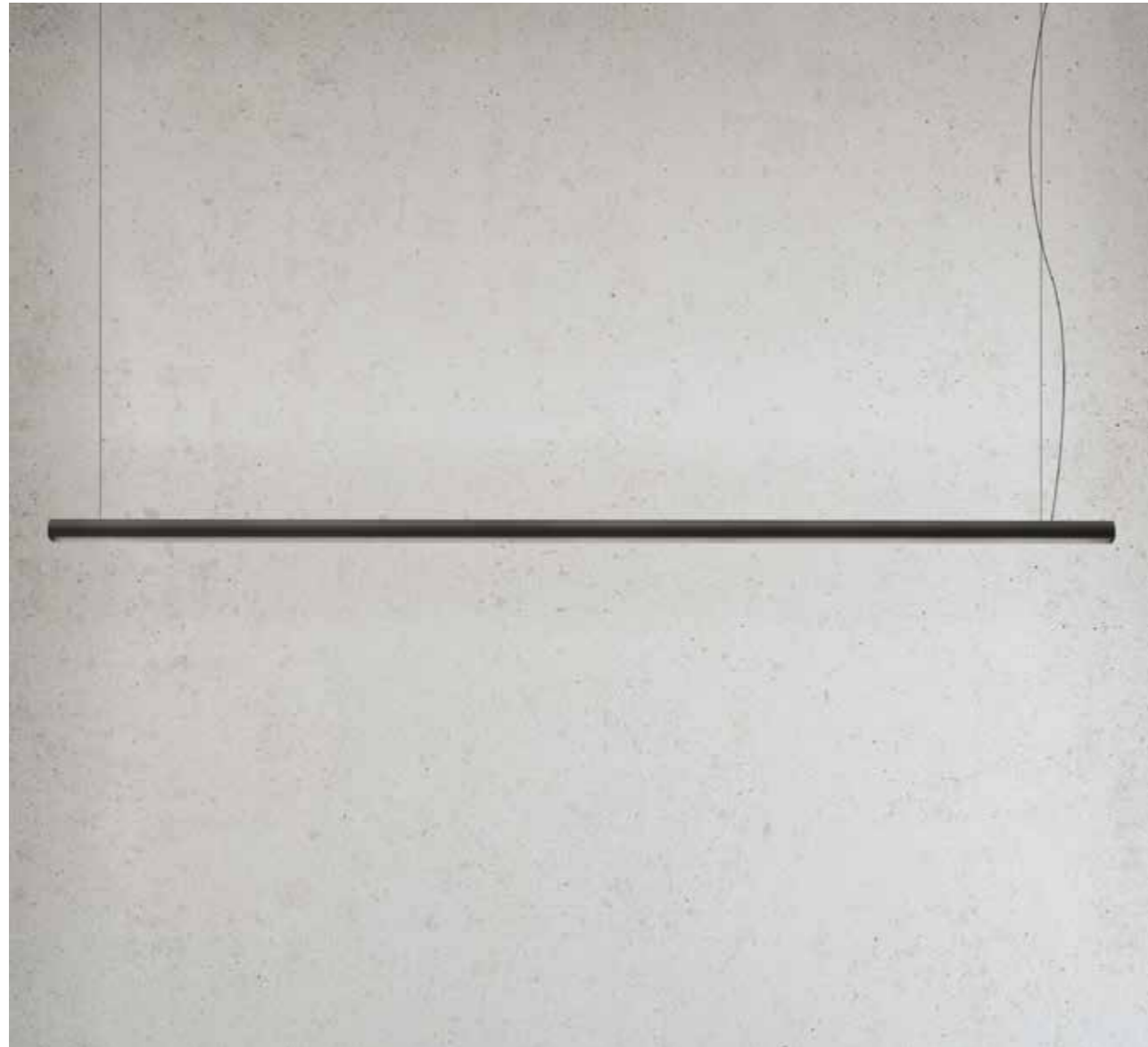

BOX ON/OFF INCLUSO / INCLUDED

IL BOX IN DOTAZIONE È SEMPRE IN FINITURA BIANCO INTONACO. A RICHIESTA SI PUÒ ORDINARE NELLE ALTRE FINITURE A CATALOGO. THE BOX PROVIDED IS ALWAYS IN PLASTER WHITE FINISH. ON REQUEST YOU CAN HAVE OTHER CATALOG FINISHES.

CAVO ALIMENTAZIONE: 200 cm
ALIMENTATION CABLE: 200 cm
CAVI SOSPENSIONE IN ACCIAIO: 200 cm
SUSPENSION CABLES IN STEEL: 200 cm

DATI TECNICI
TECHNICAL DATA

	100 cm	150 cm	200 cm
Nominal LED Flux:	↑ 2160 lm - 2160 lm ↓	↑ 3240 lm - 3240 lm ↓	↑ 4320 lm - 4320 lm ↓
Flux Tot:	↑ 1728 lm - 1728 lm ↓	↑ 2592 lm - 2592 lm ↓	↑ 3456 lm - 3456 lm ↓
Output:	90 lm/W	90 lm/W	90 lm/W
CCT:	3000 K	3000 K	3000 K
CRI:	>90	>90	>90
Power:	↑ 24.0W - 24.0W ↓	↑ 36.0W - 36.0W ↓	↑ 48.0W - 48.0W ↓
Power Tot:	48.0W (700 LED/m)	72.0W (700 LED/m)	96.0W (700 LED/m)
Weight:	1.90 Kg	2.30 Kg	3.80 Kg

Profilo/Profile: Alluminio/aluminum

Cover: Opale-satinata/opal-satin

FINITURA STRUTTURA FINISHES	COLORE CAVO WIRE COLOR	100 cm	150 cm	200 cm
		CODICE CODE	CODICE CODE	CODICE CODE
ARGILLA CLAY	BIANCO/WHITE	2044B01003	2066B01003	2088B01003
	NERO/BLACK	2044N01003	2066N01003	2088N01003
	BORDEAUX BORDEAUX	2044D01003	2066D01003	2088D01003
	TRASPARENTE/TRANSPARENT	2044T01003	2066T01003	2088T01003
BIANCO INTONACO/WHITE	BIANCO/WHITE	2044B30003	2066B30003	2088B30003
	NERO/BLACK	2044N30003	2066N30003	2088N30003
	BORDEAUX BORDEAUX	2044D30003	2066D30003	2088D30003
	TRASPARENTE/TRANSPARENT	2044T30003	2066T30003	2088T30003
NERO CARAVAGGIO/BLACK	BIANCO/WHITE	2044B40003	2066B40003	2088B40003
	NERO/BLACK	2044N40003	2066N40003	2088N40003
	BORDEAUX BORDEAUX	2044D40003	2066D40003	2088D40003
	TRASPARENTE/TRANSPARENT	2044T40003	2066T40003	2088T40003
MOKA MOCHA	BIANCO/WHITE	2044B05003	2066B05003	2088B05003
	NERO/BLACK	2044N05003	2066N05003	2088N05003
	BORDEAUX BORDEAUX	2044D05003	2066D05003	2088D05003
	TRASPARENTE/TRANSPARENT	2044T05003	2066T05003	2088T05003
CROMO/CHROME	BIANCO/WHITE	2044B08003	2066B08003	2088B08003
	NERO/BLACK	2044N08003	2066N08003	2088N08003
	BORDEAUX BORDEAUX	2044D08003	2066D08003	2088D08003
	TRASPARENTE/TRANSPARENT	2044T08003	2066T08003	2088T08003
ORO CALIFORNIA/GOLD	BIANCO/WHITE	2044B09003	2066B09003	2088B09003
	NERO/BLACK	2044N09003	2066N09003	2088N09003
	BORDEAUX BORDEAUX	2044D09003	2066D09003	2088D09003
	TRASPARENTE/TRANSPARENT	2044T09003	2066T09003	2088T09003
ARAMEN COPPER	BIANCO/WHITE	2044B10003	2066B10003	2088B10003
	NERO/BLACK	2044N10003	2066N10003	2088N10003
	BORDEAUX BORDEAUX	2044D10003	2066D10003	2088D10003
	TRASPARENTE/TRANSPARENT	2044T10003	2066T10003	2088T10003
ARGENTO COMETA/SILVER COMET	BIANCO/WHITE	2044B12003	2066B12003	2088B12003
	NERO/BLACK	2044N12003	2066N12003	2088N12003
	BORDEAUX BORDEAUX	2044D12003	2066D12003	2088D12003
	TRASPARENTE/TRANSPARENT	2044T12003	2066T12003	2088T12003
OTTONE VENEZIANO/BRASS	BIANCO/WHITE	2044B13003	2066B13003	2088B13003
	NERO/BLACK	2044N13003	2066N13003	2088N13003
	BORDEAUX BORDEAUX	2044D13003	2066D13003	2088D13003
	TRASPARENTE/TRANSPARENT	2044T13003	2066T13003	2088T13003



“design rettangolare”

Il design rettangolare di RIGALED è stato pensato fin da subito per presentare alla nostra clientela, una sospensione con un carattere estremamente deciso ed accattivante, esaltandone gli elementi illuminotecnici in esso contenuti. Le ottiche attive disegnate al suo interno, ben evidente, il diffusore arretrato in policarbonato opale, i led di ultima generazione fino a 280 led/mt, per eliminare “l’effetto puntiforme”, l’efficienza ottenuta arriva fino a 105 lm/mt. Le basse luminanze, la direzionalità dei flussi luminosi, rendono questo progetto estremamente moderno e facile da inserire in tutti i luoghi dove sono richiesti i più alti standard di qualità in termini di comfort visivo.

The square design of RIGALED was developed to offer a suspended lamp with an extremely definite and charming character. The active optics inside, the opal polycarbonate screen, the latest generation of high-efficiency LEDs with up to 180 LED-s/m, the low luminance, make this project extremely modern and suitable for every place where it’s required the highest quality standards in terms of visual comfort.



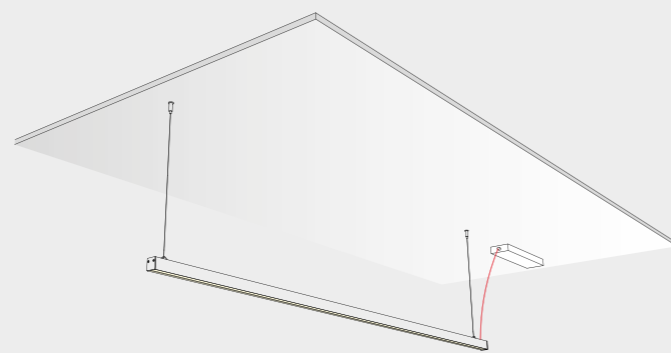
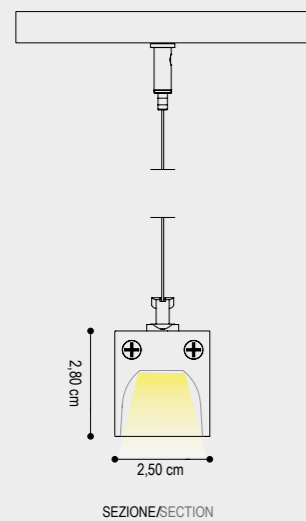
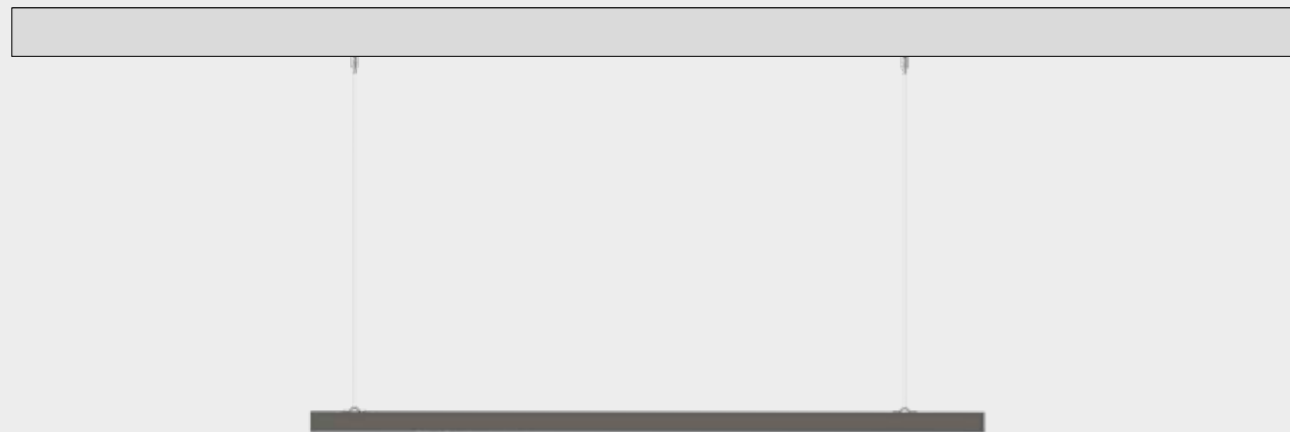

LA SOSPENSIONE RIGALED PREVEDE L'INSTALLAZIONE DELL'OTTICA ARRETRATA
THE RIGALED SUSPENSION PROVIDES THE INSTALLATION OF THE BACKGROUND OPTICS

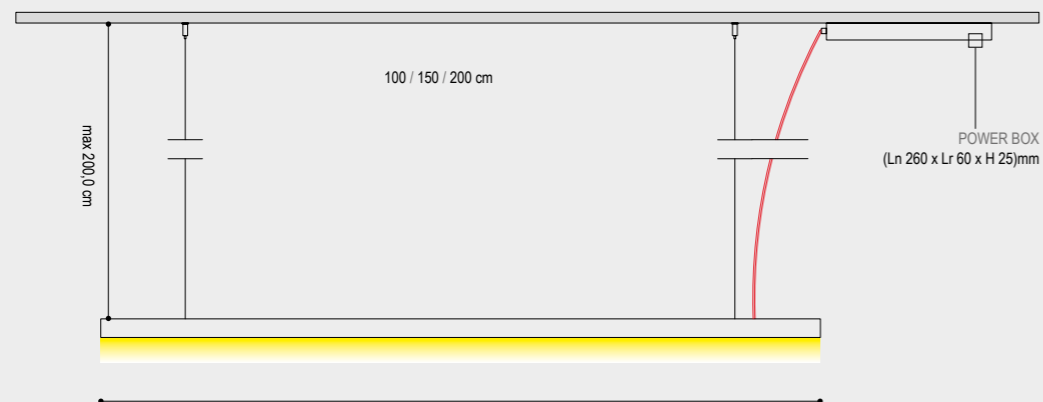

DATI TECNICI
TECHNICAL DATA

	100 cm	150 cm	200 cm
Nominal LED Flux:	2100 lm	3150 lm	4200 lm
Flux Tot:	1680 lm	2520 lm	3360 lm
Output:	105 lm/W	105 lm/W	105 lm/W
CCT:	3000 K	3000 K	3000 K
CRI:	>95	>95	>95
Power Tot:	20.0W	30.0W	40.0W
Weight:	1.30 Kg	2.00 Kg	2.60 Kg

Profilo/Profile: Alluminio/aluminum

Cover: Opale/opal



BOX ON/OFF INCLUSO / INCLUDED

IL BOX IN DOTAZIONE È SEMPRE IN
FINITURA BIANCO INTONACO.
A RICHIESTA SI PUÒ ORDINARE NELLE
ALTRE FINITURE A CATALOGO.
THE BOX PROVIDED IS ALWAYS IN PLA-
STER WHITE FINISH. ON REQUEST YOU
CAN HAVE OTHER CATALOG FINISHES.

CAVO ALIMENTAZIONE: 200 cm
ALIMENTATION CABLE: 200 cm
CAVI SOSPENSIONE IN ACCIAIO: 200 cm
SUSPENSION CABLES IN STEEL: 200 cm

FINITURA STRUTTURA FINISHES	COLORE CAVO WIRE COLOR	100 cm	150 cm	200 cm
		CODICE CODE	CODICE CODE	CODICE CODE
BIANCO INTONACO/WHITE	BIANCO/WHITE	2526B03100	2526B03150	2526B03200
	BORDEAUX BORDEAUX	2526D03100	2526D03150	2526D03200
	TRASPARENTE/TRANSPARENT	2526T03100	2526T03150	2526T03200
NERO CARAVAGGIO BLACK	BIANCO/WHITE	2526B04100	2526B04150	2526B04200
	BORDEAUX BORDEAUX	2526D04100	2526D04150	2526D04200
	TRASPARENTE/TRANSPARENT	2526T04100	2526T04150	2526T04200
CROMO CHROME	BIANCO/WHITE	2526B08100	2526B08150	2526B08200
	BORDEAUX BORDEAUX	2526D08100	2526D08150	2526D08200
	TRASPARENTE/TRANSPARENT	2526T08100	2526T08150	2526T08200
ORO CALIFORNIA/GOLD	BIANCO/WHITE	2526B09100	2526B09150	2526B09200
	BORDEAUX BORDEAUX	2526D09100	2526D09150	2526D09200
	TRASPARENTE/TRANSPARENT	2526T09100	2526T09150	2526T09200
ARAMEN COPPER	BIANCO/WHITE	2526B10100	2526B10150	2526B10200
	BORDEAUX BORDEAUX	2526D10100	2526D10150	2526D10200
	TRASPARENTE/TRANSPARENT	2526T10100	2526T10150	2526T10200
ARGENTO COMETA/SILVER COMET	BIANCO/WHITE	2526B12100	2526B12150	2526B12200
	BORDEAUX BORDEAUX	2526D12100	2526D12150	2526D12200
	TRASPARENTE/TRANSPARENT	2526T12100	2526T12150	2526T12200
OTTONE VENEZIANO BRASS	BIANCO/WHITE	2526B13100	2526B13150	2526B13200
	BORDEAUX BORDEAUX	2526D13100	2526D13150	2526D13200
	TRASPARENTE/TRANSPARENT	2526T13100	2526T13150	2526T13200



BOX ON/OFF INCLUSO / INCLUDED

IL BOX IN DOTAZIONE È SEMPRE IN FINITURA BIANCO INTONACO. A RICHIESTA SI PUÒ ORDINARE NELLE ALTRE FINITURE A CATALOGO. THE BOX PROVIDED IS ALWAYS IN PLASTER WHITE FINISH. ON REQUEST YOU CAN HAVE OTHER CATALOG FINISHES.

CAVO ALIMENTAZIONE: 200 cm
ALIMENTATION CABLE: 200 cm
CAVI SOSPENSIONE IN ACCIAIO: 200 cm
SUSPENSION CABLES IN STEEL: 200 cm

DATI TECNICI
TECHNICAL DATA

	100 cm	150 cm	200 cm
Nominal LED Flux:	2160 lm	3240 lm	4320 lm
Flux Tot:	1728 lm	2592 lm	3456 lm
Output:	90 lm/W	90 lm/W	90 lm/W
CCT:	3000 K	3000 K	3000 K
CRI:	>90	>90	>90
Power Tot:	24.0W	36.0W	48.0W
Weight:	1.30 Kg	2.00 Kg	2.60 Kg

Profilo/Profile: Alluminio/aluminum

Cover: Opale/opal

FINITURA STRUTTURA
FINISHES

- ARGILLA CLAY
- BIANCO INTONACO/WHITE
- NERO CARAVAGGIO/BLACK
- CROMO/CHROME
- ORO CALIFORNIA/GOLD
- ARAMEN COPPER
- TITANIO/TITANIUM
- BRONZO RIACI/RIACI BRONZE
- VERDE COSTA/GREEN COAST
- NERO E ORO/BLACK AND GOLD
- NERO-CROMO/BLACK-CHROME

COLORE CAVO
WIRE COLOR

TRASPARENTE
TRANSPARENT

	100 cm	150 cm	200 cm
CODICE CODE	2524T01003	2536T01003	2548T01003
CODICE CODE	2524T03003	2536T03003	2548T03003
CODICE CODE	2524T04003	2536T04003	2548T04003
CODICE CODE	2524T08003	2536T08003	2548T08003
CODICE CODE	2524T09003	2536T09003	2548T09003
CODICE CODE	2524T10003	2536T10003	2548T10003
CODICE CODE	2524T14003	2536T14003	2548T14003
CODICE CODE	2524T15003	2536T15003	2548T15003
CODICE CODE	2524T16003	2536T16003	2548T16003
CODICE CODE	2524T04093	2536T04093	2548T04093
CODICE CODE	2524T04083	2536T04083	2548T04083

DATI TECNICI
TECHNICAL DATA

	150 cm
Nominal LED Flux:	3240 lm
Flux Tot:	2592 lm
Output:	90 lm/W
CCT:	3000 K
CRI:	>90
Power Tot:	36.0W (700 LED/m)
Weight:	2.00 Kg

Profilo/Profile: Alluminio/aluminum
Cover: Opale/opal

FINITURA STRUTTURA
FINISHES

- BIANCO INTONACO/WHITE
- NERO CARAVAGGIO/BLACK
- CROMO/CHROME
- ORO CALIFORNIA/GOLD
- ARAMEN COPPER
- TITANIO/TITANIUM
- BRONZO RIACI/RIACI BRONZE
- VERDE COSTA/GREEN COAST
- NERO E ORO/BLACK AND GOLD
- NERO-CROMO/BLACK-CHROME

COLORE CAVO
WIRE COLOR

TRASPARENTE
TRANSPARENT

	150 cm		
	CODICE 2700K CODE 2700K	CODICE 3000K CODE 3000K	CODICE 4000K CODE 4000K
	2572T03150	2573T03150	2574T03150
	2572T04150	2573T04150	2574T04150
	2572T08150	2573T08150	2574T08150
	2572T09150	2573T09150	2574T09150
	2572T10150	2573T10150	2574T10150
	2572T14150	2573T14150	2574T14150
	2572T15150	2573T15150	2574T15150
	2572T16150	2573T16150	2574T16150
	2572T49150	2573T49150	2574T49150
	2572T48150	2573T48150	2574T48150



“dimensioni ridotte per tutti gli ambienti”

Pensare a un prodotto e immaginarsi lo spazio architeturale che dovrà illuminare non è sempre facile. Soprattutto quando si tratta di un ambiente senza controsoffitti, in molti casi si ricorre a un illuminazione per mezzo di apparecchi a sospensione.

SEGMENTO è stato pensato con dimensioni ridotte in estruso di alluminio con diffusore in policarbonato e cavo in tessuto. La sua forma moderna ed elegante gli permette di essere inserito in tutti gli ambienti siano essi destinati al relax o al lavoro, rendendoli armoniosi nelle forme e nei colori.

Thinking about a product and imagine the architectural space in which it will be placed is not simple. Especially regarding location without false ceiling and very often is chosen a pendant luminaires.

SEGMENTO has been designed with reduced dimension of the extruded aluminum, with polycarbonat diffusor and a fabric cable. The modern and elegant type allows to install it all over, in places of relax or in offices, making them harmonious in shape and colors.

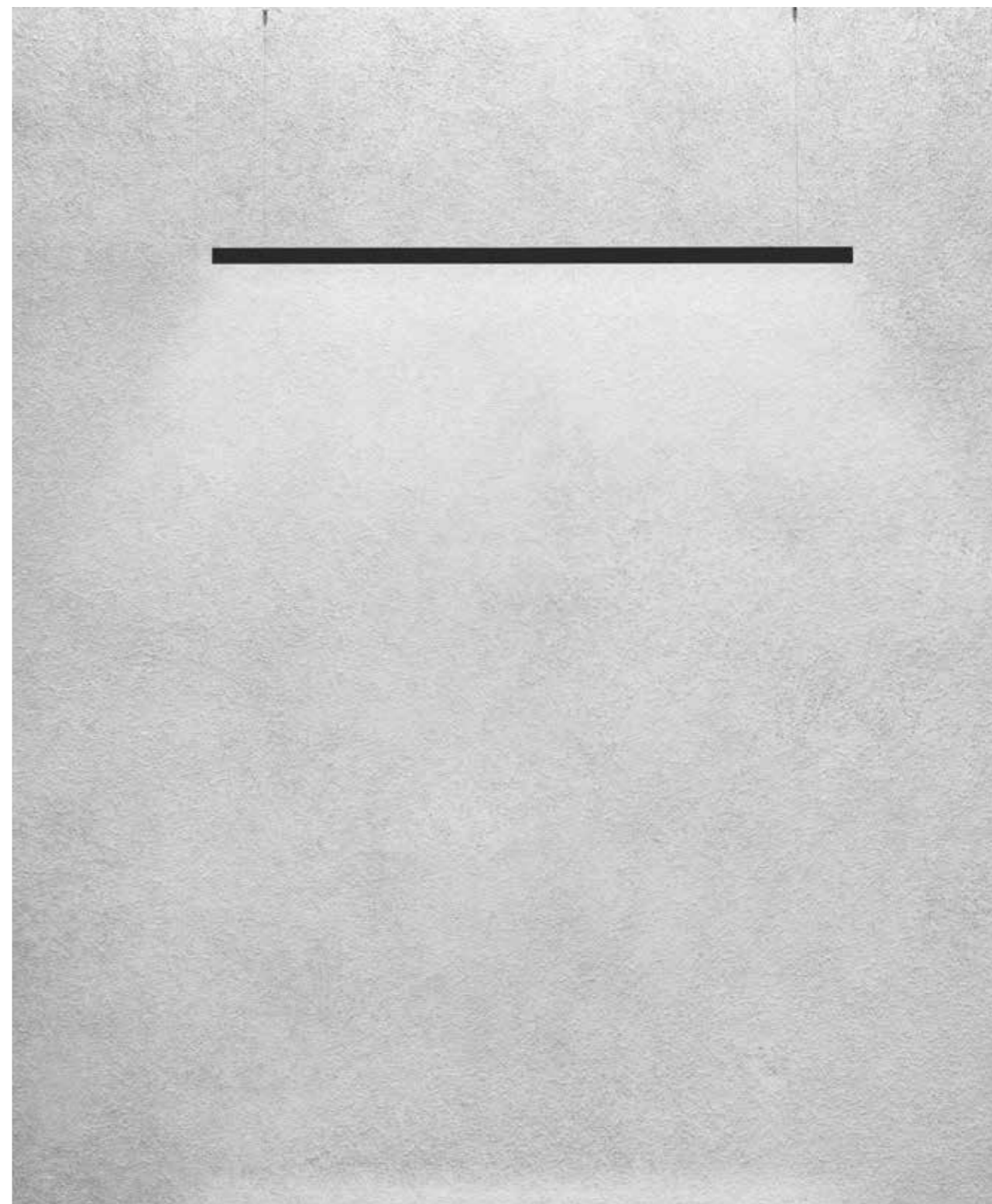

segmento

24W - 36W - 48W

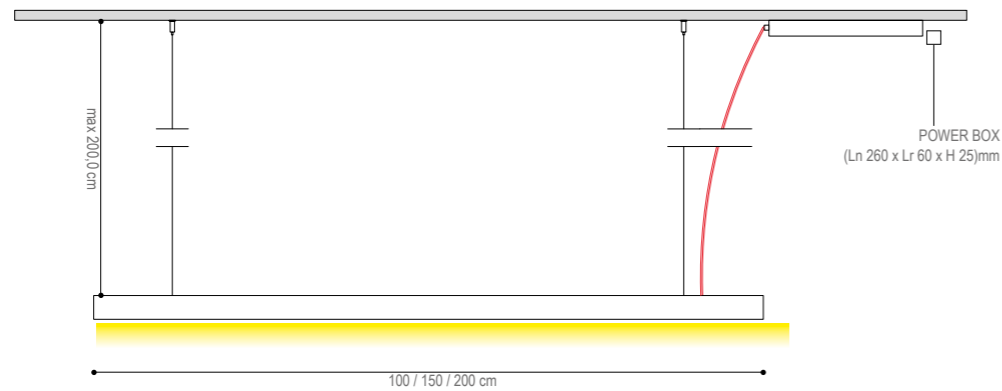
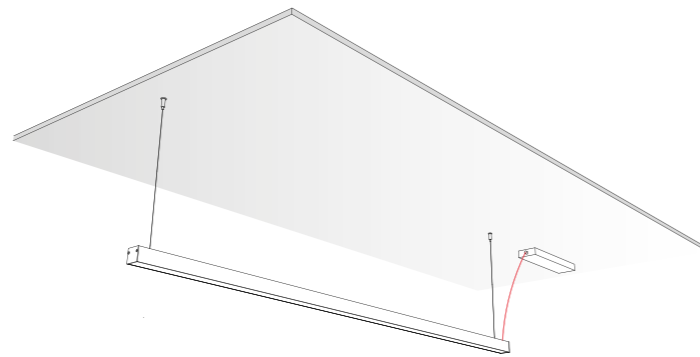
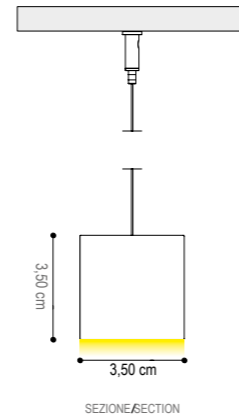

segmento

24W - 36W - 48W

scheda tecnica

BOX ON/OFF INCLUSO / INCLUDED

IL BOX IN DOTAZIONE È SEMPRE IN FINITURA BIANCO INTONACO. A RICHIESTA SI PUÒ ORDINARE NELLE ALTRE FINITURE A CATALOGO. THE BOX PROVIDED IS ALWAYS IN PLASTER WHITE FINISH. ON REQUEST YOU CAN HAVE OTHER CATALOG FINISHES.

CAVO ALIMENTAZIONE: 200 cm
ALIMENTATION CABLE: 200 cm
CAVI SOSPENSIONE IN ACCIAIO: 200 cm
SUSPENSION CABLES IN STEEL: 200 cm

DATI TECNICI
TECHNICAL DATA

	100 cm	150 cm	200 cm
Nominal LED Flux:	2160 lm	3240 lm	4320 lm
Flux Tot:	1730 lm	2592 lm	3460 lm
Output:	90 lm/W	90 lm/W	90 lm/W
CCT:	3000 K	3000 K	3000 K
CRI:	>90	>90	>90
Power Tot:	24.0W (700 LED/m)	36.0W (700 LED/m)	48.0W (700 LED/m)
Weight:	1.30 Kg	2.00 Kg	2.60 Kg

Profilo/Profile: Alluminio/aluminum

Cover: Opale/opal

FINITURA STRUTTURA FINISHES	COLORE CAVO WIRE COLOR	100 cm	150 cm	200 cm
		CODICE CODE	CODICE CODE	CODICE CODE
ARGILLA CLAY	BIANCO/WHITE	11024B0103	11036B0103	11048B0103
	NERO BLACK	11024N0103	11036N0103	11048N0103
	BORDEAUX BORDEAUX	11024D0103	11036D0103	11048D0103
	TRASPARENTE/TRANSPARENT	11024T0103	11036T0103	11048T0103
BIANCO INTONACO/WHITE	BIANCO/WHITE	11024B3003	11036B3003	11048B3003
	NERO BLACK	11024N3003	11036N3003	11048N3003
	BORDEAUX BORDEAUX	11024D3003	11036D3003	11048D3003
	TRASPARENTE/TRANSPARENT	11024T3003	11036T3003	11048T3003
NERO CARAVAGGIO BLACK	BIANCO/WHITE	11024B4003	11036B4003	11048B4003
	NERO BLACK	11024N4003	11036N4003	11048N4003
	BORDEAUX BORDEAUX	11024D4003	11036D4003	11048D4003
	TRASPARENTE/TRANSPARENT	11024T4003	11036T4003	11048T4003
MOKA MOCHA	BIANCO/WHITE	11024B0503	11036B0503	11048B0503
	NERO BLACK	11024N0503	11036N0503	11048N0503
	BORDEAUX BORDEAUX	11024D0503	11036D0503	11048D0503
	TRASPARENTE/TRANSPARENT	11024T0503	11036T0503	11048T0503
CROMO CHROME	BIANCO/WHITE	11024B0803	11036B0803	11048B0803
	NERO BLACK	11024N0803	11036N0803	11048N0803
	BORDEAUX BORDEAUX	11024D0803	11036D0803	11048D0803
	TRASPARENTE/TRANSPARENT	11024T0803	11036T0803	11048T0803
ORO CALIFORNIA/GOLD	BIANCO/WHITE	11024B0903	11036B0903	11048B0903
	NERO BLACK	11024N0903	11036N0903	11048N0903
	BORDEAUX BORDEAUX	11024D0903	11036D0903	11048D0903
	TRASPARENTE/TRANSPARENT	11024T0903	11036T0903	11048T0903
ARAMEN COPPER	BIANCO/WHITE	11024B1003	11036B1003	11048B1003
	NERO BLACK	11024N1003	11036N1003	11048N1003
	BORDEAUX BORDEAUX	11024D1003	11036D1003	11048D1003
	TRASPARENTE/TRANSPARENT	11024T1003	11036T1003	11048T1003
GRIGIO AVIO/ GREY AVIO	BIANCO/WHITE	11024B1103	11036B1303	11048B1103
	NERO BLACK	11024N1103	11036N1303	11048N1103
	BORDEAUX BORDEAUX	11024D1103	11036D1303	11048D1103
	TRASPARENTE/TRANSPARENT	11024T1103	11036T1303	11048T1103
TITANIO/TITANIUM	BIANCO/WHITE	11024B1403	11036B1403	11048B1403
	NERO BLACK	11024N1403	11036N1403	11048N1403
	BORDEAUX BORDEAUX	11024D1403	11036D1403	11048D1403
	TRASPARENTE/TRANSPARENT	11024T1403	11036T1403	11048T1403
BRONZO RIACI/RIACI BRONZE	BIANCO/WHITE	11024B1503	11036B1503	11048B1503
	NERO BLACK	11024N1503	11036N1503	11048N1503
	BORDEAUX BORDEAUX	11024D1503	11036D1503	11048D1503
	TRASPARENTE/TRANSPARENT	11024T1503	11036T1503	11048T1503



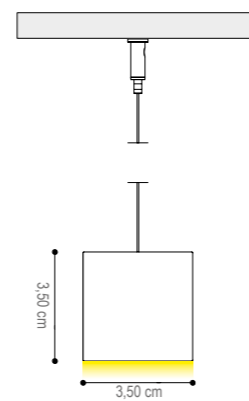
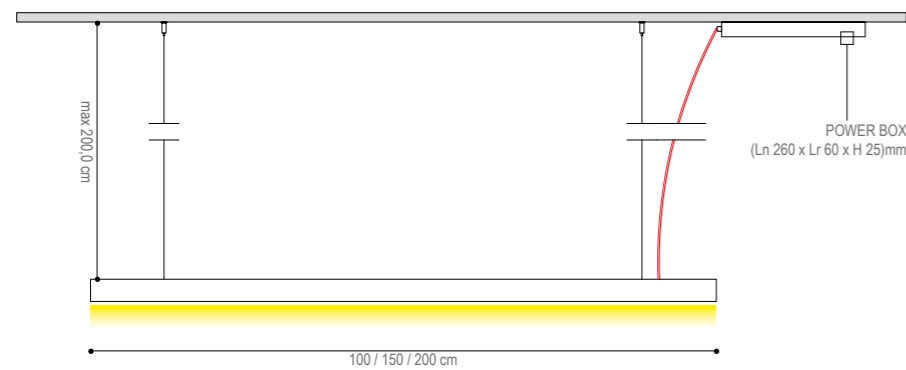
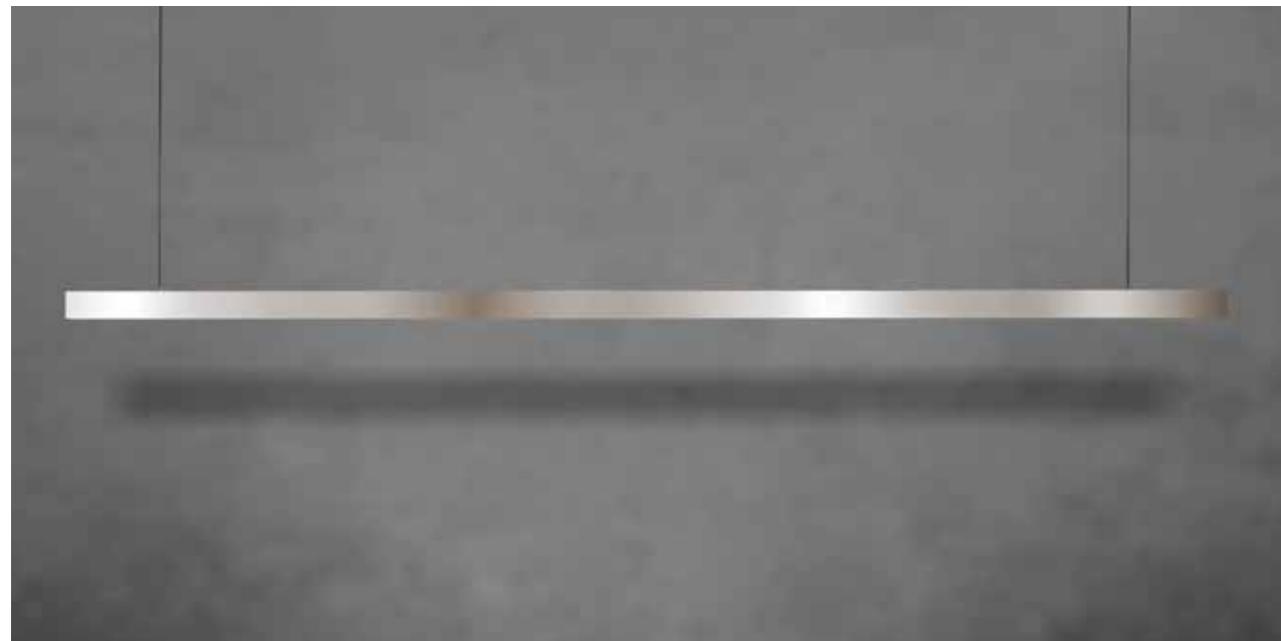

DATI TECNICI
TECHNICAL DATA

	100 cm	150 cm	200 cm
Nominal LED Flux:	3024 lm	4536 lm	6048 lm
Flux Tot:	2419 lm	3630 lm	4838 lm
Output:	140 lm/W	140 lm/W	140 lm/W
CCT:	3000 K	3000 K	3000 K
CRI:	>90	>90	>90
Power Tot:	21.6W	32.4W	43.2W
Weight:	1.30 Kg	2.00 Kg	2.60 Kg

Profilo/Profile: Alluminio/aluminum

Cover: Prismaticata/prismatic



BOX ON/OFF INCLUSO / INCLUDED

IL BOX IN DOTAZIONE È SEMPRE IN FINITURA BIANCO INTONACO. A RICHIESTA SI PUÒ ORDINARE NELLE ALTRE FINITURE A CATALOGO. THE BOX PROVIDED IS ALWAYS IN PLASTER WHITE FINISH. ON REQUEST YOU CAN HAVE OTHER CATALOG FINISHES

VALORE DELL' UGR < 19 LUNGO L'ASSE TRASVERSALE UGR VALUE <19 ALONG THE TRANSVERSAL AXIS

FINITURA STRUTTURA FINISHES	COLORE CAVO WIRE COLOR	100 cm	150 cm	200 cm
		CODICE CODE	CODICE CODE	CODICE CODE
ARGILLA/CLAY	TRASPARENTE TRANSPARENT	11020T0133	11030T0133	11040T0133
ARGENTO OPACO/MATT SILVER		11020T0233	11030T0233	11040T0233
BIANCO INTONACO/WHITE		11020T0333	11030T0333	11040T0333
NERO CARAVAGGIO/BLACK		11020T0433	11030T0433	11040T0433
CROMO/CHROME		11020T0833	11030T0833	11040T0833
ORO CALIFORNIA/GOLD		11020T0933	11030T0933	11040T0933
ARAMEN/COPPER		11020T1033	11030T1033	11040T1033
GRIGIO AVIO GREY AVIO		11020T1133	11030T1133	11040T1133
OTTONE VENEZIANO VENETIAN BRASS		11020T1333	11030T1333	11040T1333
TITANIO/TITANIUM		11020T1433	11030T1433	11030T1433
BRONZO RIACI/RIACI BRONZE		11020T1533	11030T1533	11030T1533
VERDE COSTA/GREEN COAST		11020T1633	11030T1633	11030T1633

“dimensioni ridotte per tutti gli ambienti”

Pensare a un prodotto e immaginarsi lo spazio architettonico che dovrà illuminare non è sempre facile. Soprattutto quando si tratta di un ambiente senza controsoffitti, in molti casi si ricorre a un'illuminazione per mezzo di apparecchi a sospensione. SEGMENTO è stato pensato con dimensioni ridotte in estruso di alluminio con diffusore in policarbonato e cavo in tessuto. La sua forma moderna ed elegante gli permette di essere inserito in tutti gli ambienti siano essi destinati al relax o al lavoro, rendendoli armoniosi nelle forme e nei colori.

Thinking about a product and imagine the architectural space in which it will be placed is not simple. Especially regarding location without false ceiling and very often is chosen a pendant luminaire. SEGMENTO has been designed with reduced dimension of the extruded aluminum, with polycarbonat diffusor and a fabric cable. The modern and elegant type allows to install it all over, in places of relax or in offices, making them harmonious in shape and colors.



punto



punto

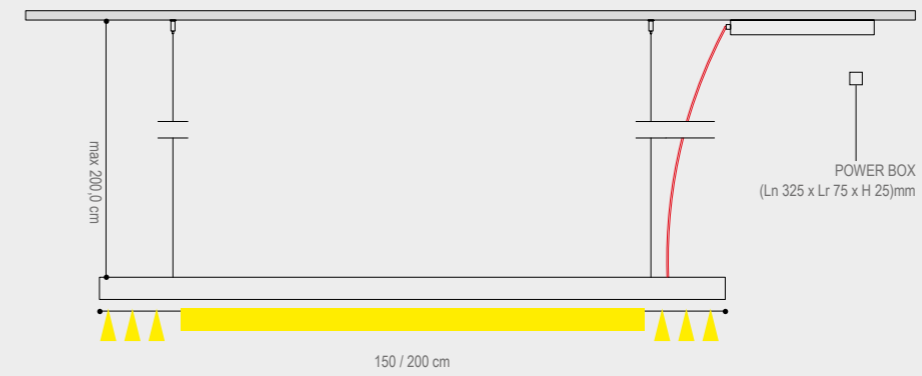

scheda tecnica

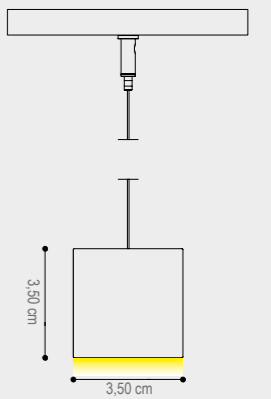

BOX ON/OFF INCLUSO / INCLUDED

IL BOX IN DOTAZIONE È SEMPRE IN FINITURA BIANCO INTONACO. A RICHIESTA SI PUÒ ORDINARE NELLE ALTRE FINITURE A CATALOGO. THE BOX PROVIDED IS ALWAYS IN PLASTER WHITE FINISH. ON REQUEST YOU CAN HAVE OTHER CATALOG FINISHES.

CAVO ALIMENTAZIONE: 200 cm
ALIMENTATION CABLE: 200 cm
CAVI SOSPENSIONE IN ACCIAIO: 200 cm
SUSPENSION CABLES IN STEEL: 200 cm

DATI TECNICI
TECHNICAL DATA

	15cm+120cm+15cm	15cm+170cm+15cm
Nominal LED Flux:	4680 lm	6630 lm
Nominal SPOT Flux:	1524 lm	1524 lm
Flux Tot:	3235 lm	4579 lm
Output:	130 lm/W + 121 lm/W	130 lm/W + 121 lm/W
CCT:	3000 K	3000 K
CRI:	>90	>90
LED Power Tot:	36.0W	51.0W
LENS Power Tot:	18.0W (3W x 6)	18.0W (3W x 6)
Weight:	1.95 Kg	2.60 Kg

Profilo/Profile: Alluminio/aluminum Cover: Opale/opal

FINITURA STRUTTURA
FINISHES

- GRIGIO VESUVIO ANTHRACITE
- ARGILLA/CLAY
- ARGENTO OPACO/MATT SILVER
- BIANCO INTONACO/WHITE
- NERO CARAVAGGIO/BLACK
- CROMO/CHROME
- ORO CALIFORNIA/GOLD
- ARAMEN/COPPER
- GRIGIO AVIO GREY AVIO
- OTTONE VENEZIANO/VENETIAN BRASS
- TITANIO/TITANIUM
- BRONZO RIACI/RIACI BRONZE
- VERDE COSTA/GREEN COAST

COLORE CAVO
WIRE COLOR

- TRASPARENTE
TRANSPARENT

	15cm+120cm+15cm		15cm+170cm+15cm	
	CODICE 2700K CODE 3000K	CODICE 3000K CODE 3000K	CODICE 2700K CODE 3000K	CODICE 3000K CODE 3000K
	1108F20015	1108F30015	1108F20020	1108F30020
	1108F20115	1108F30115	1108F20120	1108F30120
	1108F20215	1108F30215	1108F20220	1108F30220
	1108F20315	1108F30315	1108F20320	1108F30320
	1108F20415	1108F30415	1108F20420	1108F30420
	1108F20815	1108F30815	1108F20820	1108F30820
	1108F20915	1108F30915	1108F20920	1108F30920
	1108F21015	1108F31015	1108F21020	1108F31020
	1108F21115	1108F31115	1108F21120	1108F31120
	1108F21315	1108F31315	1108F21320	1108F31320
	1108F21415	1108F31415	1108F21420	1108F31420
	1108F21515	1108F31515	1108F21520	1108F31520
	1108F21615	1108F31615	1108F21620	1108F31620



“dimensioni ridotte per tutti gli ambienti ”

È la naturale evoluzione della versione “Punto” è il primo prodotto proposto da design Luce, dove abbiamo pensato di abbinare alla tecnologia dell’estrusione, la tecnologia della tornitura meccanica.

Siamo riusciti ad ottenendo un corpo illuminante in grado di generale per mezzo di led, sia Luce diffusa che luce a spot in più orientabile. Questa soluzione offre agli architetti un apparecchio molto flessibile ed unico. Per illuminare tutti gli ambienti siano essi pensati per di lavoro che per il tempo libero.

It is the natural evolution of the “Punto” version. It is the first product proposed by design Luce, where we decided to combine the technology of mechanical turning with extrusion technology.

We have succeeded in obtaining a lighting body capable of general by means of LEDs, both diffused light and additional adjustable spot light. This solution offers architects a very flexible and unique luminaire. To illuminate all environments whether they are designed for work or leisure.



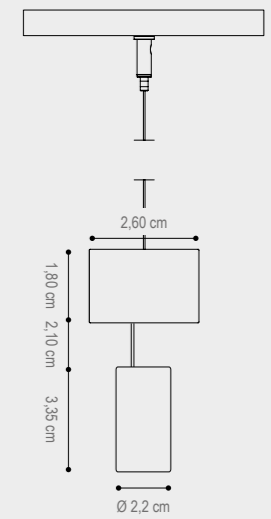
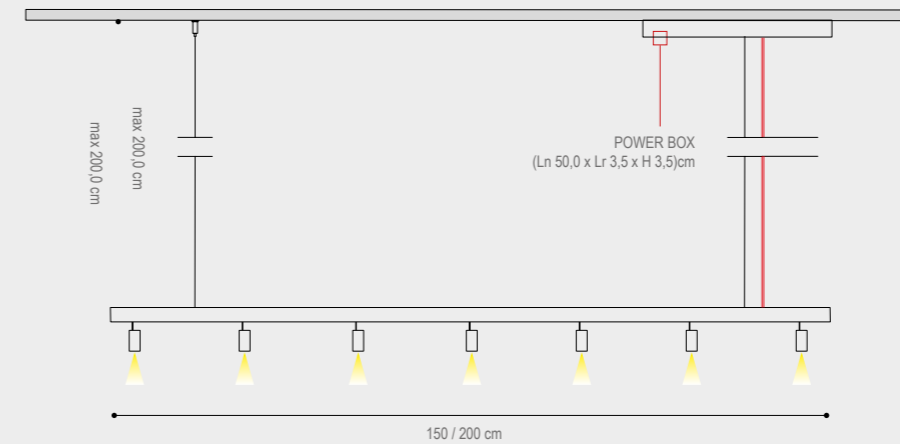

BOX ON/OFF INCLUSO / INCLUDED

IL BOX IN DOTAZIONE È SEMPRE IN FINITURA BIANCO INTONACO. A RICHIESTA SI PUÒ ORDINARE NELLE ALTRE FINITURE A CATALOGO. THE BOX PROVIDED IS ALWAYS IN PLASTER WHITE FINISH. ON REQUEST YOU CAN HAVE OTHER CATALOG FINISHES.

CAVO ALIMENTAZIONE: 200 cm
ALIMENTATION CABLE: 200 cm
CAVI SOSPENSIONE IN ACCIAIO: 200 cm
SUSPENSION CABLES IN STEEL: 200 cm

DATI TECNICI
TECHNICAL DATA

	150cm	200 cm
Nominal SPOT Flux:	950 lm	1332 lm
Flux Tot:	760 lm	1066 lm
Output:	112 lm/W	112 lm/W
CCT:	3000 K	3000 K
CRI:	>90	>90
LENS Power Tot:	4x3W 700mA	7x3W 700mA
Weight:	1.95 Kg	1.95 Kg

Profilo/Profile: Alluminio/aluminum

Cover: Opale/opal

FINITURA STRUTTURA
FINISHES

- GRIGIO VESUVIO ANTHRACITE
- ARGILLA/CLAY
- ARGENTO OPACO/MATT SILVER
- BIANCO INTONACO/WHITE
- NERO CARAVAGGIO BLACK
- CROMO/CHROME
- ORO CALIFORNIA/GOLD
- ARAMEN/COPPER
- OTTONE VENEZIANO/VENETIAN BRASS
- TITANIO/TITANIUM
- BRONZO RIACI/RIACI BRONZE
- VERDE COSTA/GREEN COAST

COLORE CAVO
WIRE COLOR

- TRASPARENTE
TRANSPARENT

	150cm		200 cm	
	CODICE 2700K CODE 2700K	CODICE 3000K CODE 3000K	CODICE 2700K CODE 3000K	CODICE 3000K CODE 3000K
	103C700150	103C800150	103C700200	103C800200
	103C701150	103C801150	103C701200	103C801200
	103C702150	103C802150	103C702200	103C802200
	103C703150	103C803150	103C703200	103C803200
	103C704150	103C804150	103C704200	103C804200
	103C708150	103C808150	103C708200	103C808200
	103C709150	103C809150	103C709200	103C809200
	103C710150	103C810150	103C710200	103C810200
	103C713150	103C813150	103C713200	103C813200
	103C714150	103C814150	103C714200	103C814200
	103C715150	103C815150	103C715200	103C815200
	103C716150	103C816150	103C716200	103C816200



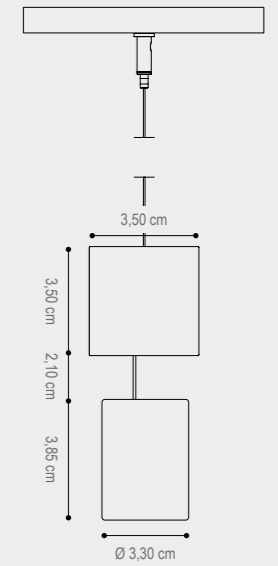
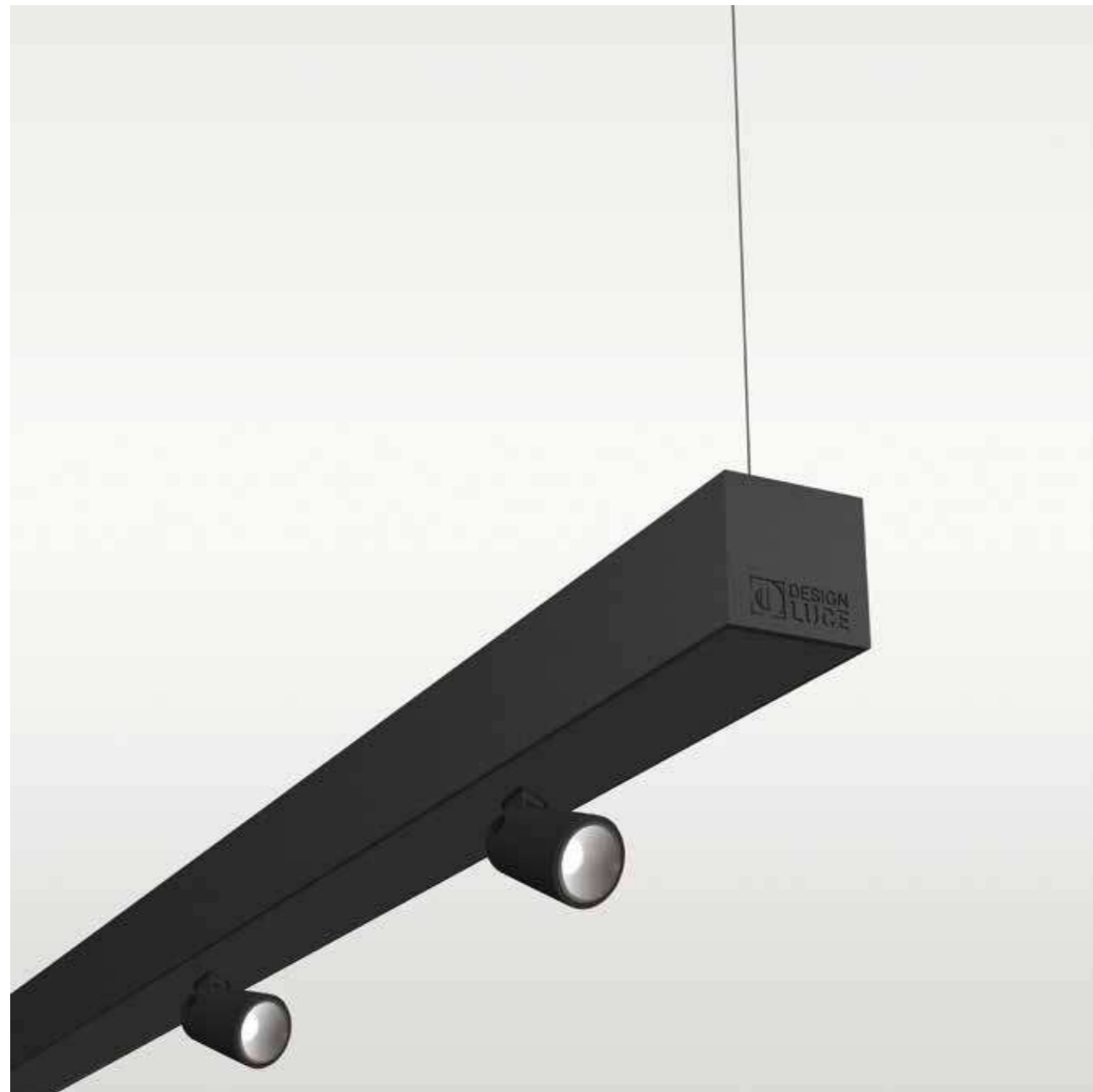

BOX ON/OFF INCLUSO / INCLUDED

IL BOX IN DOTAZIONE È SEMPRE IN FINITURA BIANCO INTONACO. A RICHIESTA SI PUÒ ORDINARE NELLE ALTRE FINITURE A CATALOGO. THE BOX PROVIDED IS ALWAYS IN PLASTER WHITE FINISH. ON REQUEST YOU CAN HAVE OTHER CATALOG FINISHES.

CAVO ALIMENTAZIONE: 200 cm
ALIMENTATION CABLE: 200 cm
CAVI SOSPENSIONE IN ACCIAIO: 200 cm
SUSPENSION CABLES IN STEEL: 200 cm

DATI TECNICI
TECHNICAL DATA

	150cm	200 cm
Nominal SPOT Flux:	1000 lm	1960 lm
Flux Tot:	925 lm	1568 lm
Output:	100 lm/W	100 lm/W
CCT:	3000 K	3000 K
CRI:	>90	>90
LENS Power Tot:	4x5W 700mA	7x5W 700mA
Weight:	1.95 Kg	1.95 Kg
Profilo/Profile:	Alluminio/aluminum	
Cover:	Opale/opal	

FINITURA STRUTTURA
FINISHES

- GRIGIO VESUVIO ANTHRACITE
- ARGILLA/CLAY
- ARGENTO OPACO/MATT SILVER
- BIANCO INTONACO/WHITE
- NERO CARAVAGGIO BLACK
- CROMO/CHROME
- ORO CALIFORNIA/GOLD
- ARAMEN/COPPER
- OTTONE VENEZIANO/VENETIAN BRASS
- TITANIO/TITANIUM
- BRONZO RIACI/RIACI BRONZE
- VERDE COSTA/GREEN COAST

COLORE CAVO
WIRE COLOR

- TRASPARENTE
TRANSPARENT

	150cm		200 cm	
	CODICE 2700K CODE 2700K	CODICE 3000K CODE 3000K	CODICE 2700K CODE 3000K	CODICE 3000K CODE 3000K
	110CA00150	110CB00150	110CA00200	110CB00200
	110CA01150	110CB01150	110CA01200	110CB01200
	110CA02150	110CB02150	110CA02200	110CB02200
	110CA03150	110CB03150	110CA03200	110CB03200
	110CA04150	110CB04150	110CA04200	110CB04200
	110CA08150	110CB08150	110CA08200	110CB08200
	110CA09150	110CB09150	110CA09200	110CB09200
	110CA10150	110CB10150	110CA10200	110CB10200
	110CA13150	110CB13150	110CA13200	110CB13200
	110CA14150	110CB14150	110CA14200	110CB14200
	110CA15150	110CB15150	110CA15200	110CB15200
	110CA16150	110CB16150	110CA16200	110CB16200



“protagonista discreto”

Un apparecchio semplice, minimale e elegante da sospendere nei luoghi di lavoro e nelle abitazioni. TITANIA non invade l'ambiente, anzi ne diventa il protagonista discreto. Le sue finiture, diffusore opale e cavo in tessuto lo impreziosiscono e ne potenziano le occasioni di utilizzo. La versione a luce diretta e indiretta conferisce a TITANIA maggiore versatilità. Una “nuance” di luce verso il soffitto potrà rendere più confortevole l'abitare nell'ambiente. Con le due versioni, diretta e diretta/indiretta, TITANIA si fa formidabile strumento progettuale.

TITANIA is a simple lamp, minimal and elegant perfect to be installed in working places and home's areas. TITANIA does not invade the environment but it is his discreet protagonist. His finishes, his opal cover and the fabric cable makes it interesting, precious and versatile, thanks also to the direct/indirect light version. For these reasons, together with the direct light version, TITANIA becomes a formidable designing tool.



titania

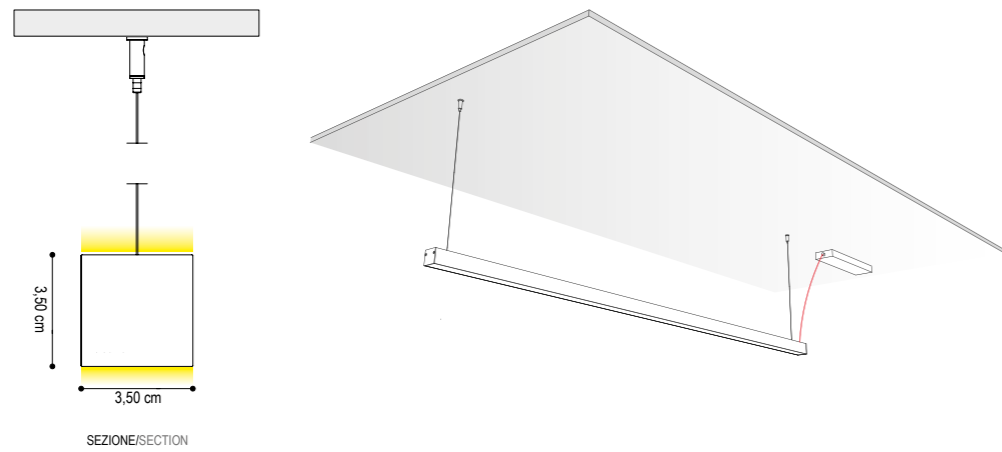

SEZIONE/SECTION

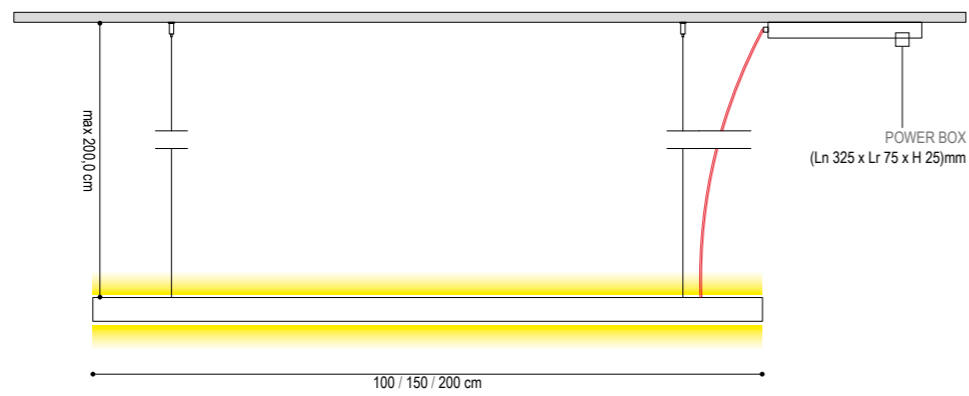

titania

scheda tecnica



DATI TECNICI
TECHNICAL DATA

BOX ON/OFF INCLUSO / INCLUDED

IL BOX IN DOTAZIONE È SEMPRE IN FINITURA BIANCO INTONACO.
A RICHIESTA SI PUÒ ORDINARE NELLE ALTRE FINITURE A CATALOGO.
THE BOX PROVIDED IS ALWAYS IN PLASTER WHITE FINISH. ON REQUEST YOU CAN HAVE OTHER CATALOG FINISHES.

ARTICOLI COMPRESI NEL CODICE:
ITEMS INCLUDED IN THE CODE:
CAVO ALIMENTAZIONE: 200 cm
ALIMENTATION CABLE: 200 cm
CAVI SOSPENSIONE IN ACCIAIO: 200 cm
SUSPENSION CABLES IN STEEL: 200 cm

	100 cm	150 cm	200 cm
Nominal LED Flux:	↑ 2048 lm - 2048 lm ↓	↑ 3098 lm - 3098 lm ↓	↑ 4043 lm - 4043 lm ↓
Flux Tot:	↑ 1639 lm - 1639 lm ↓	↑ 2479 lm - 2479 lm ↓	↑ 3234 lm - 3234 lm ↓
Output:	105 lm/W	105 lm/W	105 lm/W
CCT:	3000 K	3000 K	3000 K
CRI:	>95	>95	>95
Power:	↑ 19.5W - 19.5W ↓	↑ 29.5W - 29.5W ↓	↑ 38.5W - 38.5W ↓
Power Tot:	39.0W	59.0W	77.0W
Weight:	1.40 Kg	2.10 Kg	2.80 Kg

Profilo/Profile: Alluminio/aluminum

Cover: Opale-satinata/opal-satin

FINITURA STRUTTURA FINISHES	COLORE CAVO WIRE COLOR	100 cm CODICE CODE	150 cm CODICE CODE	200 cm CODICE CODE
ARGILLA CLAY	BIANCO/WHITE	11640B0103	11660B0103	11680B0103
	NERO BLACK	11640N0103	11660N0103	11680N0103
	BORDEAUX BORDEAUX	11640D0103	11660D0103	11680D0103
	TRASPARENTE/TRANSPARENT	11640T0103	11660T0103	11680T0103
BIANCO INTONACO/WHITE	BIANCO/WHITE	11640B3003	11660B3003	11680B3003
	NERO BLACK	11640N3003	11660N3003	11680N3003
	BORDEAUX BORDEAUX	11640D3003	11660D3003	11680D3003
	TRASPARENTE/TRANSPARENT	11640T3003	11660T3003	11680T3003
NERO CARAVAGGIO BLACK	BIANCO/WHITE	11640B4003	11660B4003	11680B4003
	NERO BLACK	11640N4003	11660N4003	11680N4003
	BORDEAUX BORDEAUX	11640D4003	11660D4003	11680D4003
	TRASPARENTE/TRANSPARENT	11640T4003	11660T4003	11680T4003
CROMO/CHROME	BIANCO/WHITE	11640B0803	11660B0803	11680B0803
	NERO BLACK	11640N0803	11660N0803	11680N0803
	BORDEAUX BORDEAUX	11640D0803	11660D0803	11680D0803
	TRASPARENTE/TRANSPARENT	11640T0803	11660T0803	11680T0803
ORO CALIFORNIA/GOLD	BIANCO/WHITE	11640B0903	11660B0903	11680B0903
	NERO BLACK	11640N0903	11660N0903	11680N0903
	BORDEAUX BORDEAUX	11640D0903	11660D0903	11680D0903
	TRASPARENTE/TRANSPARENT	11640T0903	11660T0903	11680T0903
ARAMEN COPPER	BIANCO/WHITE	11640B1003	11660B1003	11680B1003
	NERO BLACK	11640N1003	11660N1003	11680N1003
	BORDEAUX BORDEAUX	11640D1003	11660D1003	11680D1003
	TRASPARENTE/TRANSPARENT	11640T1003	11660T1003	11680T1003
GRIGIO AVIO/GREY AVIO	BIANCO/WHITE	11640B1103	11660B1103	11680B1103
	NERO BLACK	11640N1103	11660N1103	11680N1103
	BORDEAUX BORDEAUX	11640D1103	11660D1103	11680D1103
	TRASPARENTE/TRANSPARENT	11640T1103	11660T1103	11680T1103
TITANIO/TITANIUM	BIANCO/WHITE	11640B1403	11660B1403	11680B1403
	NERO BLACK	11640N1403	11660N1403	11680N1403
	BORDEAUX BORDEAUX	11640D1403	11660D1403	11680D1403
	TRASPARENTE/TRANSPARENT	11640T1403	11660T1403	11680T1403
BRONZO RIACI/RIACI BRONZE	BIANCO/WHITE	11640B1503	11660B1503	11680B1503
	NERO BLACK	11640N1503	11660N1503	11680N1503
	BORDEAUX BORDEAUX	11640D1503	11660D1503	11680D1503
	TRASPARENTE/TRANSPARENT	11640T1503	11660T1503	11680T1503





DATI TECNICI
TECHNICAL DATA

	100 cm	150 cm	200 cm
Nominal LED Flux:	↑ 2970 lm - 2970 lm ↓	↑ 4455 lm - 4455 lm ↓	↑ 5940 lm - 5940 lm ↓
Flux Tot:	↑ 2376 lm - 2376 lm ↓	↑ 3564 lm - 3564 lm ↓	↑ 4752 lm - 4752 lm ↓
Output:	135 lm/W	135 lm/W	135 lm/W
CCT:	3000 K	3000 K	3000 K
CRI:	>95	>95	>95
Power:	↑ 22.0W - 22.0W ↓	↑ 33.0W - 33.0W ↓	↑ 44.0W - 44.0W ↓
Power Tot:	44.0W	66.0W	88.0W
Weight:	1.40 Kg	2.10 Kg	2.80 Kg

Profilo/Profile: Alluminio/aluminum

Cover: Prismatizzata-Satinata/prismatic-satin



BOX ON/OFF INCLUSO / INCLUDED

IL BOX IN DOTAZIONE È SEMPRE IN FINITURA BIANCO INTONACO. A RICHIESTA SI PUÒ ORDINARE NELLE ALTRE FINITURE A CATALOGO. THE BOX PROVIDED IS ALWAYS IN PLASTER WHITE FINISH. ON REQUEST YOU CAN HAVE OTHER CATALOG FINISHES.

ARTICOLI COMPRESI NEL CODICE:
ITEMS INCLUDED IN THE CODE:
CAVO ALIMENTAZIONE: 200 cm
ALIMENTATION CABLE: 200 cm
CAVI SOSPENSIONE IN ACCIAIO: 200 cm
SUSPENSION CABLES IN STEEL: 200 cm

VALORE DELL' UGR < 19
LUNGO L'ASSE TRASVERSALE

UGR VALUE <19
ALONG THE TRANSVERSAL AXIS

	100 cm	150 cm	200 cm
FINITURA STRUTTURA FINISHES	CODICE CODE	CODICE CODE	CODICE CODE
ARGILLA CLAY	116050T013	116075T013	116100T013
ARGENTO OPACO MATT SILVER	116050T023	116075T023	116100T023
BIANCO INTONACO/WHITE	116050T033	116075T033	116100T033
NERO CARAVAGGIO BLACK	116050T043	116075T043	116100T043
CROMO/CHROME	116050T083	116075T083	116100T083
ORO CALIFORNIA/GOLD	116050T093	116075T093	116100T093
ARAMEN COPPER	116050T103	116075T103	116100T103
GRIGIO AVIO GREY AVIO	116050T113	116075T113	116100T113
OTTONE VENEZIANO/VENETIAN BRASS	116050T133	116075T133	116100T133
TITANIO/TITANIUM	116050T143	116075T143	116100T143
BRONZO RIACI/RIACI BRONZE	116050T153	116075T153	116100T153
VERDE COSTA/GREEN COAST	116050T163	116075T163	116100T163
COLORE CAVO WIRE COLOR	CODICE CODE	CODICE CODE	CODICE CODE
TRASPARENTE TRANSPARENT	116050T093	116075T093	116100T093

“luce diretta e indiretta”

Un apparecchio semplice, minimale ed elegante da sospendere nei luoghi di lavoro e nelle abitazioni. BIVERSO non invade l'ambiente, anzi ne diventa il protagonista discreto. Le sue finiture, diffusore opale e cavo in tessuto lo impreziosiscono e ne potenziano le occasioni di utilizzo. La versione a luce diretta e indiretta conferisce a BIVERSO maggiore versatilità. Una “nuance” di luce verso il soffitto potrà rendere più confortevole l'abitare nell'ambiente. Con le due versioni, diretta e diretta/indiretta, BIVERSO si fa formidabile strumento progettuale.

BIVERSO is a simple lamp, minimal and elegant perfect to be installed in working places and home's areas. TITANIA does not invade the environment but it is his discreet protagonist. His finishes, his opal cover and the fabric cable make it interesting, precious and versatile, thanks also to the direct/indirect light version. For these reasons, together with the direct light version, TITANIA becomes a formidable designing tool.



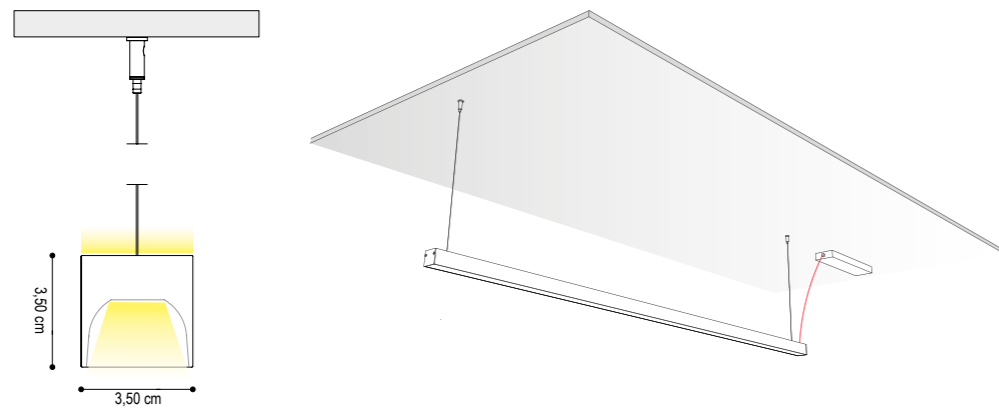

SEZIONE/SECTION
 CARATTERISTICA DEL BIVERSO È LA SUA OTTICA ARRETRATA
 CHARACTERISTIC OF THE BIVERSO IS ITS BACKWARD OPTICS

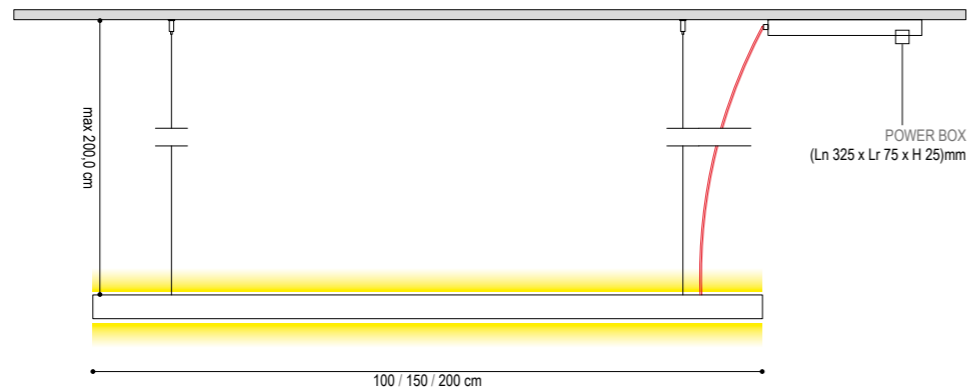

BOX ON/OFF INCLUSO / INCLUDED

IL BOX IN DOTAZIONE È SEMPRE IN FINITURA BIANCO INTONACO. A RICHIESTA SI PUÒ ORDINARE NELLE ALTRE FINITURE A CATALOGO. THE BOX PROVIDED IS ALWAYS IN PLASTER WHITE FINISH. ON REQUEST YOU CAN HAVE OTHER CATALOG FINISHES.

ARTICOLI COMPRESI NEL CODICE:
 ITEMS INCLUDED IN THE CODE:
 CAVO ALIMENTAZIONE: 200 cm
 ALIMENTATION CABLE: 200 cm
 CAVI SOSPENSIONE IN ACCIAIO: 200 cm
 SUSPENSION CABLES IN STEEL: 200 cm

DATI TECNICI
 TECHNICAL DATA

	100 cm	150 cm	200 cm
Nominal LED Flux:	↑ 2160 lm - 2160 lm ↓	↑ 3240 lm - 3240 lm ↓	↑ 4320 lm - 4320 lm ↓
Flux Tot:	↑ 1728 lm - 1728 lm ↓	↑ 2592 lm - 2592 lm ↓	↑ 3456 lm - 3456 lm ↓
Output:	90 lm/W	90 lm/W	90 lm/W
CCT:	3000 K	3000 K	3000 K
CRI:	>90	>90	>90
Power:	↑ 24.0W - 24.0W ↓	↑ 36.0W - 36.0W ↓	↑ 48.0W - 48.0W ↓
Power Tot:	48.0W	72.0W	96.0W
Weight:	1.40 Kg	2.10 Kg	2.80 Kg

Profilo/Profile: Alluminio/aluminum

Cover: Opale-satinata/opal-satin

FINITURA STRUTTURA FINISHES	COLORE CAVO WIRE COLOR	100 cm CODICE CODE	150 cm CODICE CODE	200 cm CODICE CODE
ARGILLA CLAY	BIANCO/WHITE	11644B0103	11666B0103	11688B0103
	NERO/BLACK	11644N0103	11666N0103	11688N0103
	TRASPARENTE/TRANSPARENT	11644T0103	11666T0103	11688T0103
BIANCO INTONACO/WHITE	BIANCO/WHITE	11644B0303	11666B0303	11688B0303
	NERO/BLACK	11644N0303	11666N0303	11688N0303
	TRASPARENTE/TRANSPARENT	11644T0303	11666T0303	11688T0303
NERO CARAVAGGIO BLACK	BIANCO/WHITE	11644B0403	11666B0403	11688B0403
	NERO/BLACK	11644N0403	11666N0403	11688N0403
	TRASPARENTE/TRANSPARENT	11644T0403	11666T0403	11688T0403
CROMO/CHROME	BIANCO/WHITE	11644B0803	11666B0803	11688B0803
	NERO/BLACK	11644N0803	11666N0803	11688N0803
	TRASPARENTE/TRANSPARENT	11644T0803	11666T0803	11688T0803
ORO CALIFORNIA/GOLD	BIANCO/WHITE	11644B0903	11666B0903	11688B0903
	NERO/BLACK	11644N0903	11666N0903	11688N0903
	TRASPARENTE/TRANSPARENT	11644T0903	11666T0903	11688T0903
ARAMEN COPPER	BIANCO/WHITE	11644B1003	11666B1003	11688B1003
	NERO/BLACK	11644N1003	11666N1003	11688N1003
	TRASPARENTE/TRANSPARENT	11644T1003	11666T1003	11688T1003
GRIGIO AVIO GREY AVIO	BIANCO/WHITE	11644B1103	11666B1103	11688B1103
	NERO/BLACK	11644N1103	11666N1103	11688N1103
	TRASPARENTE/TRANSPARENT	11644T1103	11666T1103	11688T1103
OTTONE VENEZIANO VENETIAN BRASS	BIANCO/WHITE	11644B1303	11666B1303	11688B1303
	NERO/BLACK	11644N1303	11666N1303	11688N1303
	TRASPARENTE/TRANSPARENT	11644T1303	11666T1303	11688T1303
TITANIO/TITANIUM	BIANCO/WHITE	11644B1403	11666B1403	11688B1403
	NERO/BLACK	11644N1403	11666N1403	11688N1403
	TRASPARENTE/TRANSPARENT	11644T1403	11666T1403	11688T1403
BRONZO RIACI/RIACI BRONZE	BIANCO/WHITE	11644B1503	11666B1503	11688B1503
	NERO/BLACK	11644N1503	11666N1503	11688N1503
	TRASPARENTE/TRANSPARENT	11644T1503	11666T1503	11688T1503
NERO E ORO/BLACK AND GOLD	BIANCO/WHITE	11644B4903	11666B4903	11688B4903
	NERO/BLACK	11644N4903	11666N4903	11688N4903
	TRASPARENTE/TRANSPARENT	11644T4903	11666T4903	11688T4903
NERO-CROMO/BLACK-CHROME	BIANCO/WHITE	11644B4803	11666B4803	11688B4803
	NERO/BLACK	11644N4803	11666N4803	11688N4803
	TRASPARENTE/TRANSPARENT	11644T4803	11666T4803	11688T4803



“luce diretta e indiretta”

TRAVLED è stato costruito per includere e alimentazioni sempre difficili da collocare in un progetto nella sua struttura in estruso di alluminio il diffusore in policarbonato e il cavo in tessuto. Si avvale della nuova tecnologia led, al top, per qualità, resa cromatica, lumen emessi, ed accurata selezione della temperatura colore, scelta in base al progetto scenografico che vogliamo ottenere. La sua forma moderna ed elegante gli permette di essere inserito in tutti gli ambienti siano essi destinati al relax o al lavoro, rendendoli armoniosi nelle forme e nei colori.

TRAVLED has been designed for including power supplies, which are always difficult to place in a project. TRAVLED uses the newest led technologies like high LED's quality, color rendering, lumen output and accurate color temperature, according to the different projects. His modern and elegant shape allows the designer to install it all over, in relax areas or offices, making their forms and colors very harmonious.



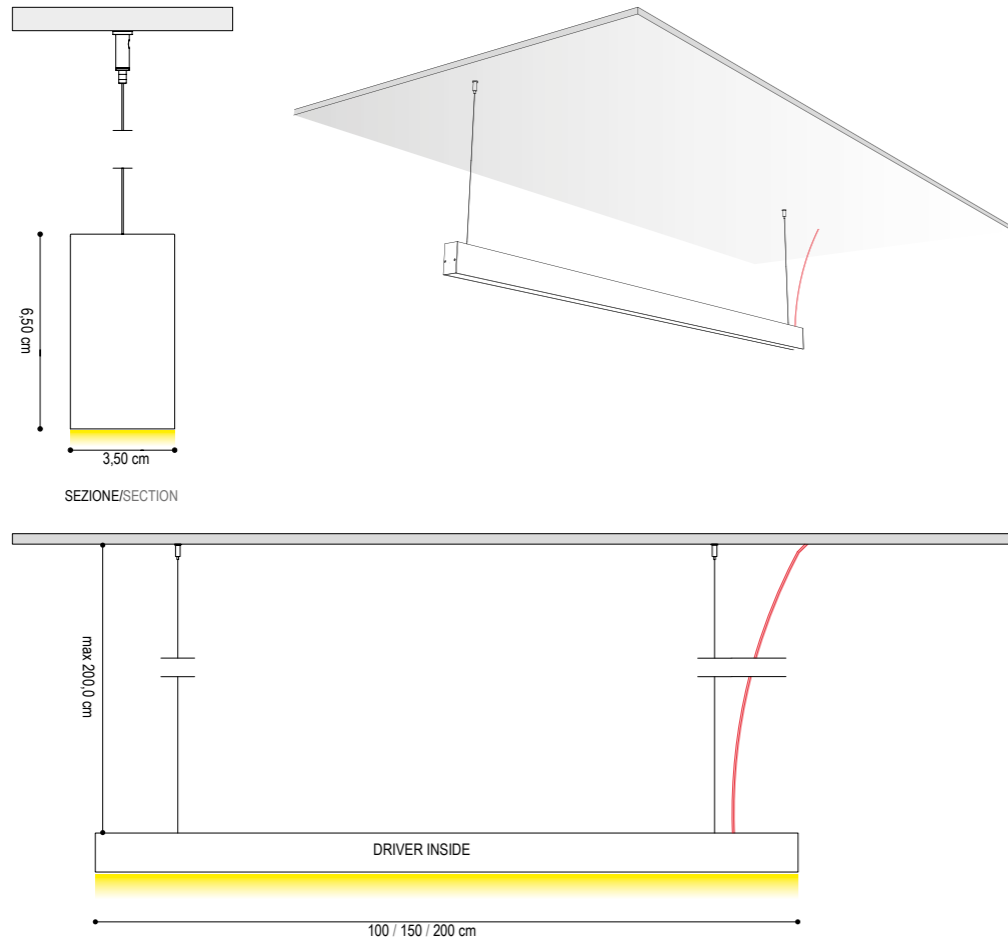

DATI TECNICI
TECHNICAL DATA

DRIVER 24V ON/OFF INCLUSO / INCLUDED
 ARTICOLI COMPRESI NEL CODICE:
 ITEMS INCLUDED IN THE CODE:
 CAVO ALIMENTAZIONE: 200 cm
 ALIMENTATION CABLE: 200 cm
 CAVI SOSPENSIONE IN ACCIAIO: 200 cm
 SUSPENSION CABLES IN STEEL: 200 cm

	100 cm	150 cm	200 cm
Nominal LED Flux:	2160 lm	3240 lm	4320 lm
Flux Tot:	1730 lm	2592 lm	3460 lm
Output:	90 lm/W	90 lm/W	90 lm/W
CCT:	3000 K	3000 K	3000 K
CRI:	>90	>90	>90
Power Tot:	24.0W	36.0W	48.0W
Weight:	1.70 Kg	2.60 Kg	3.40 Kg

Profilo/Profile: Alluminio/aluminum

Cover: Opale/opal

FINITURA STRUTTURA FINISHES	COLORE CAVO WIRE COLOR	100 cm CODICE CODE	150 cm CODICE CODE	200 cm CODICE CODE
ARGILLA CLAY	BIANCO/WHITE	11124B0103	11136B0103	11148B0103
	NERO/BLACK	11124N0103	11136N0103	11148N0103
	BORDEAUX BORDEAUX	11124D0103	11136D0103	11148D0103
	TRASPARENTE/TRANSPARENT	11124T0103	11136T0103	11148T0103
BIANCO INTONACO/WHITE	BIANCO/WHITE	11124B3003	11136B3003	11148B3003
	NERO/BLACK	11124N3003	11136N3003	11148N3003
	BORDEAUX BORDEAUX	11124D3003	11136D3003	11148D3003
	TRASPARENTE/TRANSPARENT	11124T3003	11136T3003	11148T3003
NERO CARAVAGGIO BLACK	BIANCO/WHITE	11124B4003	11136B4003	11148B4003
	NERO/BLACK	11124N4003	11136N4003	11148N4003
	BORDEAUX BORDEAUX	11124D4003	11136D4003	11148D4003
	TRASPARENTE/TRANSPARENT	11124T4003	11136T4003	11148T4003
MOKA MOCHA	BIANCO/WHITE	11124B0503	11136B0503	11148B0503
	NERO/BLACK	11124N0503	11136N0503	11148N0503
	BORDEAUX BORDEAUX	11124D0503	11136D0503	11148D0503
	TRASPARENTE/TRANSPARENT	11124T0503	11136T0503	11148T0503
CROMO CHROME	BIANCO/WHITE	11124B0803	11136B0803	11148B0803
	NERO/BLACK	11124N0803	11136N0803	11148N0803
	BORDEAUX BORDEAUX	11124D0803	11136D0803	11148D0803
	TRASPARENTE/TRANSPARENT	11124T0803	11136T0803	11148T0803
ORO CALIFORNIA/GOLD	BIANCO/WHITE	11124B0903	11136B0903	11148B0903
	NERO/BLACK	11124N0903	11136N0903	11148N0903
	BORDEAUX BORDEAUX	11124D0903	11136D0903	11148D0903
	TRASPARENTE/TRANSPARENT	11124T0903	11136T0903	11148T0903
ARAMEN COPPER	BIANCO/WHITE	11124B1003	11136B1003	11148B1003
	NERO/BLACK	11124N1003	11136N1003	11148N1003
	BORDEAUX BORDEAUX	11124D1003	11136D1003	11148D1003
	TRASPARENTE/TRANSPARENT	11124T1003	11136T1003	11148T1003
GRIGIO AVIO GREY AVIO	BIANCO/WHITE	11124B1103	11136B1103	11148B1103
	NERO/BLACK	11124N1103	11136N1103	11148N1103
	BORDEAUX BORDEAUX	11124D1103	11136D1103	11148D1103
	TRASPARENTE/TRANSPARENT	11124T1103	11136T1103	11148T1103
TITANIO/TITANIUM	BIANCO/WHITE	11124B1403	11136B1403	11148B1403
	NERO/BLACK	11124N1403	11136N1403	11148N1403
	BORDEAUX BORDEAUX	11124D1403	11136D1403	11148D1403
	TRASPARENTE/TRANSPARENT	11124T1403	11136T1403	11148T1403
BRONZO RIACI/RIACI BRONZE	BIANCO/WHITE	11124B1503	11136B1503	11148B1503
	NERO/BLACK	11124N1503	11136N1503	11148N1503
	BORDEAUX BORDEAUX	11124D1503	11136D1503	11148D1503
	TRASPARENTE/TRANSPARENT	11124T1503	11136T1503	11148T1503



travled

UGR<19

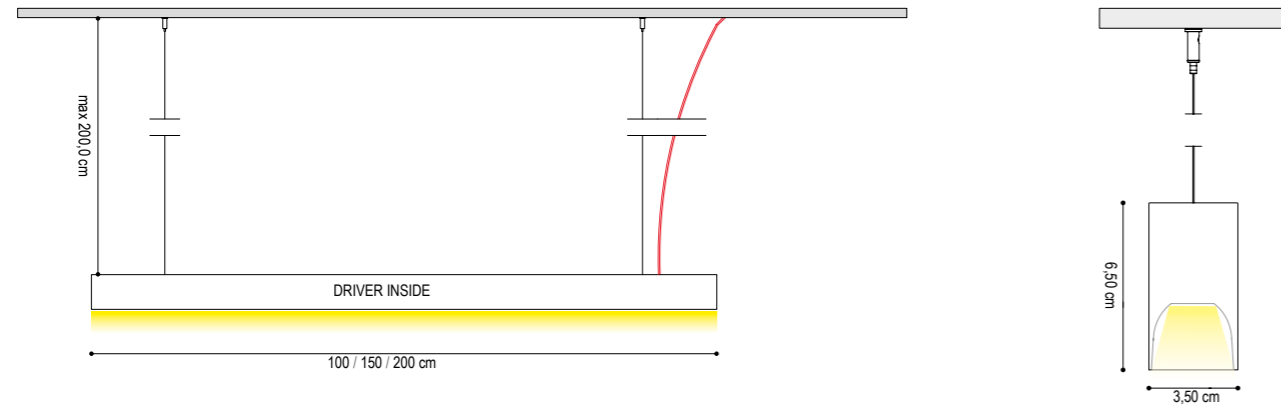
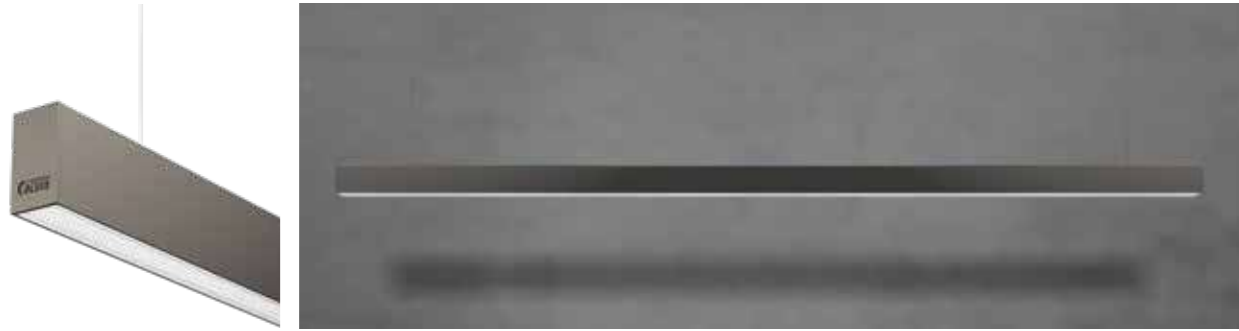

travled point

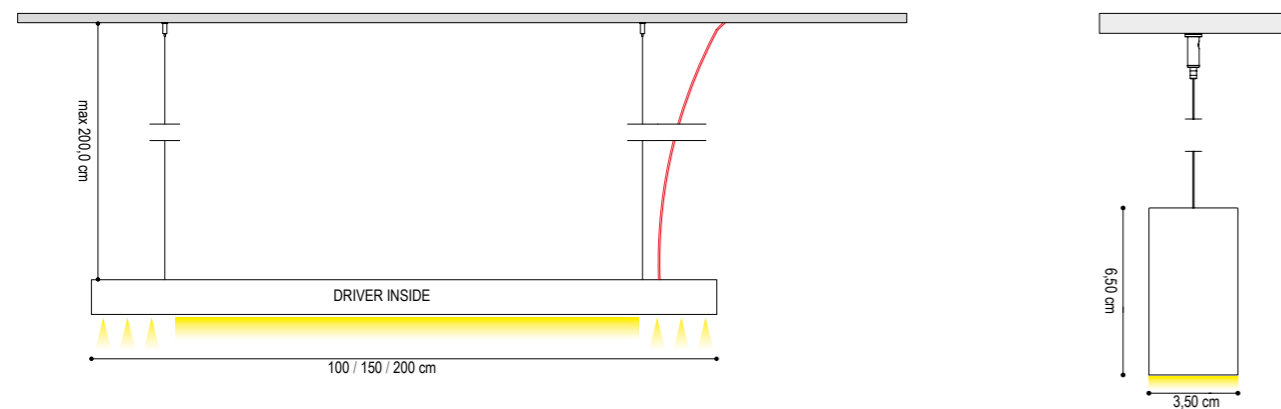

travled

UGR<19

scheda tecnica



DRIVER 24 ON/OFF INCLUSO / INCLUDED

ARTICOLI COMPRESI NEL CODICE:
ITEMS INCLUDED IN THE CODE:
CAVO ALIMENTAZIONE: 200 cm
ALIMENTATION CABLE: 200 cm
CAVI SOSPENSIONE IN ACCIAIO: 200 cm
SUSPENSION CABLES IN STEEL: 200 cm

VALORE DELL' UGR < 19
LUNGO L'ASSE TRASVERSALE

UGR VALUE <19
ALONG THE TRANSVERSAL AXIS

DATI TECNICI
TECHNICAL DATA



	100 cm	150 cm	200 cm
Nominal LED Flux:	3150 lm	4725 lm	6300 lm
Flux Tot:	2520 lm	3780 lm	5040 lm
Output:	105 lm/W	105 lm/W	105 lm/W
CCT:	3000 K	3000 K	3000 K
CRI:	>90	>90	>90
Power Tot:	30.0W	45.0W	60.0W
Weight:	1.30 Kg	2.00 Kg	2.60 Kg

Profilo/Profile: Alluminio/aluminum
Satinata/prismatic-satin Cover: Prismatizzata-

FINITURA STRUTTURA
FINISHES

- ARGILLA CLAY
- ARGENTO OPACO/MATT SILVER
- BIANCO INTONACO/WHITE
- NERO CARAVAGGIO/BLACK
- CROMO CHROME
- ORO CALIFORNIA/GOLD
- ARAMEN COPPER
- GRIGIO AVIO GREY AVIO
- OTTONE VENEZIANO/VENETIAN BRASS
- TITANIO/TITANIUM
- BRONZO RIACI/RIACI BRONZE
- VERDE COSTA/GREEN COAST

COLORE CAVO
WIRE COLOR

TRASPARENTE
TRANSPARENT

	100 cm	150 cm	200 cm
CODICE CODE	11130T0133	11145T0133	11160T0133
CODICE CODE	11130T0233	11145T0233	11160T0233
CODICE CODE	11130T0333	11145T0333	11160T0333
CODICE CODE	11130T0433	11145T0433	11160T0433
CODICE CODE	11130T0833	11145T0833	11160T0833
CODICE CODE	11130T0933	11145T0933	11160T0933
CODICE CODE	11130T1033	11145T1033	11160T1033
CODICE CODE	11130T1133	11145T1133	11160T1133
CODICE CODE	11130T1333	11145T1333	11160T1333
CODICE CODE	11130T1433	11145T1433	11160T1433
CODICE CODE	11130T1533	11145T1533	11160T1533
CODICE CODE	11130T1633	11145T1633	11160T1633

travled point



DRIVER ON/OFF INCLUSO / INCLUDED

NO POWER BOX

ARTICOLI COMPRESI NEL CODICE:
ITEMS INCLUDED IN THE CODE:
CAVO ALIMENTAZIONE: 200 cm
ALIMENTATION CABLE: 200 cm
CAVI SOSPENSIONE IN ACCIAIO: 200 cm
SUSPENSION CABLES IN STEEL: 200 cm

DATI TECNICI
TECHNICAL DATA



	15cm+120cm+15cm	15cm+170cm+15cm
Nominal LED Flux:	2520 lm	4200 lm
Nominal SPOT Flux:	1524 lm	1524 lm
Flux Tot:	3235 lm	4579 lm
Output:	105 lm/W + 121 lm/W	105 lm/W + 121 lm/W
CCT:	3000 K	3000 K
CRI:	>95	>95
LED Power Tot:	23.0W	33.0W
LENS Power Tot:	12.0W (2W x 6)	12.0W (2W x 6)
Weight:	1.95 Kg	2.60 Kg

Profilo/Profile: Alluminio/aluminum
Cover: Opale/opal

FINITURA STRUTTURA
FINISHES

- NERO E ORO/BLACK AND GOLD
- NERO-CROMO/BLACK CHROME

COLORE CAVO
WIRE COLOR

TRASPARENTE
TRANSPARENT

	15cm+120cm+15cm	15cm+170cm+15cm
CODICE 2700K CODE 2700K	1118349150	1118349200
CODICE 3000K CODE 3000K	1118449150	1118449200
CODICE 2700K CODE 2700K	1118348150	1118348200
CODICE 3000K CODE 3000K	1118448150	1118448200



“la sospensione più piccola”

MICROLINEA è la più piccola sospensione di Design Luce, indispensabile negli spazi siano essi destinati al lavoro che al relax. È il più discreto tra i sistemi esistenti, il suo diffusore arretrato riduce l'abbagliamento conferendogli una presenza impercettibile ma elegante.

MICROLINEA is the smallest suspension of DESIGN LUCE, needful in all relaxing and working spaces. It's the most discreet of the existing systems: its backward cover reduces glare, giving it an imperceptible but elegant presence.

MACROINLINEA Derivata dalla microlinea è una sospensione dal design minimale: è un sistema di illuminazione a luce indiretta particolarmente adatta agli spazi destinati al relax della persona e alle postazioni di lavoro che non richiedono una luce diretta sul piano.

MACROINLINEA Derived from, it's a suspended microininea, it's a suspension with a very minimal design.: it is an indirect lighting system, suitable particularly for relaxing and working places and working spaces .



microlinea

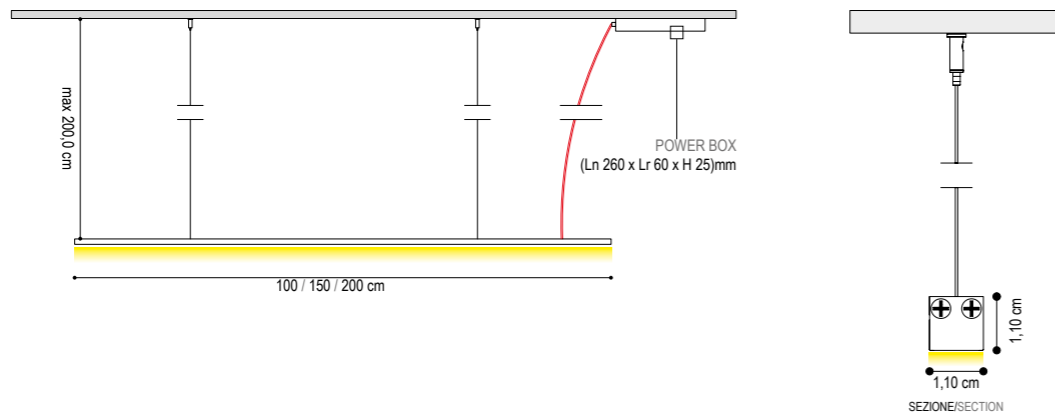
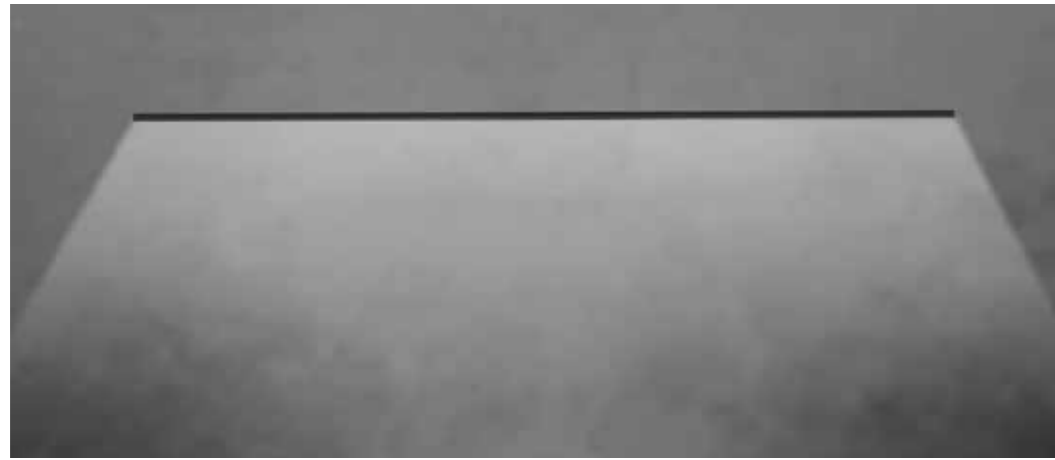

microin linea

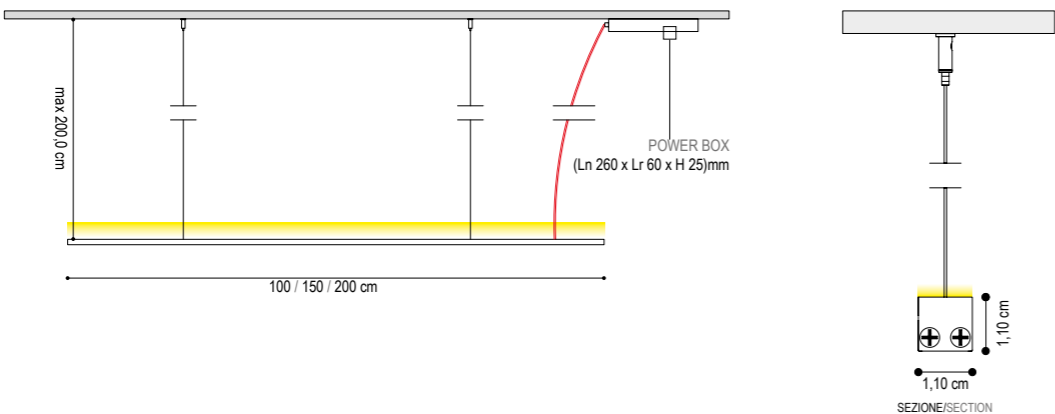
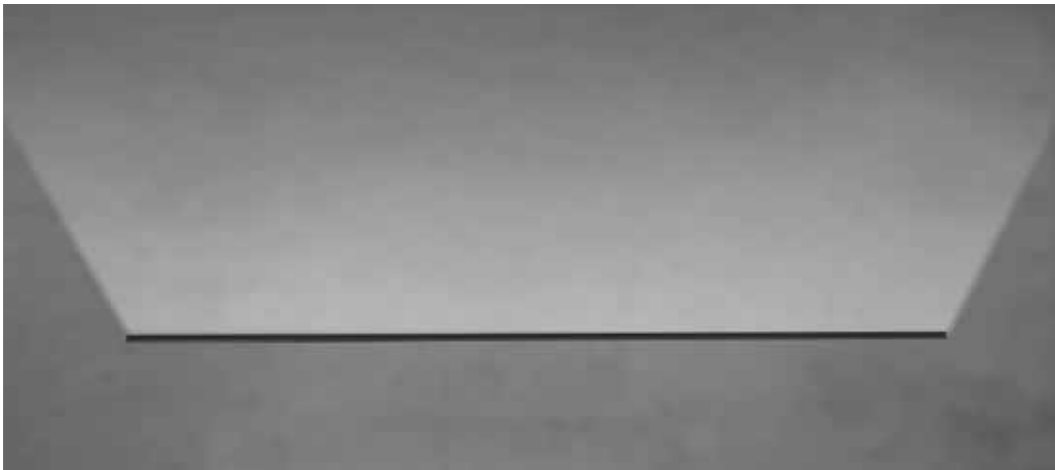

microlinea

scheda tecnica

BOX ON/OFF INCLUSO / INCLUDED

IL BOX IN DOTAZIONE È SEMPRE IN FINITURA BIANCO INTONACO. A RICHIESTA SI PUÒ ORDINARE NELLE ALTRE FINITURE A CATALOGO. THE BOX PROVIDED IS ALWAYS IN PLASTER WHITE FINISH. ON REQUEST YOU CAN HAVE OTHER CATALOG FINISHES.

ARTICOLI COMPRESI NEL CODICE: ITEMS INCLUDED IN THE CODE: CAVO ALIMENTAZIONE: 200 cm ALIMENTATION CABLE: 200 cm CAVI SOSPENSIONE IN ACCIAIO: 200 cm SUSPENSION CABLES IN STEEL: 200 cm

DATI TECNICI
TECHNICAL DATA

	100 cm	150 cm	200 cm
Nominal LED Flux:	1575 lm	2415 lm	3150 lm
Flux Tot:	1210 lm	1932 lm	2520 lm
Output:	105 lm/W	105 lm/W	105 lm/W
CCT:	3000 K	3000 K	3000 K
CRI:	>90	>90	>90
Power Tot:	15.0W	23.0W	30.0W
Weight:	0.60 Kg	0.90 Kg	1.20 Kg

Profilo/Profile: Alluminio/aluminum Cover: Opale/opal

FINITURA STRUTTURA
FINISHES

- ARGILLA CLAY
- ARGENTO OPACO/MATT SILVER
- BIANCO INTONACO/WHITE
- NERO CARAVAGGIO BLACK
- CROMO/CHROME
- ORO CALIFORNIA/GOLD
- ARAMEN COPPER
- TITANIO/TITANIUM
- BRONZO RIACI/RIACI BRONZE
- VERDE COSTA/GREEN COAST

COLORE CAVO
WIRE COLOR

TRASPARENTE
TRANSPARENT

	100 cm	150 cm	200 cm
CODICE CODE	10815T0103	10822T0103	10830T0103
CODICE CODE	10815T0203	10822T0203	10830T0203
CODICE CODE	10815T0303	10822T0303	10830T0303
CODICE CODE	10815T0403	10822T0403	10830T0403
CODICE CODE	10815T0803	10822T0803	10830T0803
CODICE CODE	10815T0903	10822T0903	10830T0903
CODICE CODE	10815T1003	10822T1003	10830T1003
CODICE CODE	10815T1403	10822T1403	10830T1403
CODICE CODE	10815T1503	10822T1503	10830T1503
CODICE CODE	10815T1603	10822T1603	10830T1603

microin linea

BOX ON/OFF INCLUSO / INCLUDED

IL BOX IN DOTAZIONE È SEMPRE IN FINITURA BIANCO INTONACO. A RICHIESTA SI PUÒ ORDINARE NELLE ALTRE FINITURE A CATALOGO. THE BOX PROVIDED IS ALWAYS IN PLASTER WHITE FINISH. ON REQUEST YOU CAN HAVE OTHER CATALOG FINISHES.

ARTICOLI COMPRESI NEL CODICE: ITEMS INCLUDED IN THE CODE: CAVO ALIMENTAZIONE: 200 cm ALIMENTATION CABLE: 200 cm CAVI SOSPENSIONE IN ACCIAIO: 200 cm SUSPENSION CABLES IN STEEL: 200 cm

DATI TECNICI
TECHNICAL DATA

	100 cm	150 cm	200 cm
Nominal LED Flux:	1575 lm	2415 lm	3150 lm
Flux Tot:	1210 lm	1932 lm	2520 lm
Output:	105 lm/W	105 lm/W	105 lm/W
CCT:	3000 K	3000 K	3000 K
CRI:	>90	>90	>90
Power Tot:	15.0W	23.0W	30.0W
Weight:	0.60 Kg	0.90 Kg	1.20 Kg

Profilo/Profile: Alluminio/aluminum Cover: Opale/opal

FINITURA STRUTTURA
FINISHES

- ARGILLA CLAY
- ARGENTO OPACO/MATT SILVER
- BIANCO INTONACO/WHITE
- NERO CARAVAGGIO BLACK
- CROMO/CHROME
- ORO CALIFORNIA/GOLD
- ARAMEN COPPER
- TITANIO/TITANIUM
- BRONZO RIACI/RIACI BRONZE
- VERDE COSTA/GREEN COAST

COLORE CAVO
WIRE COLOR

TRASPARENTE
TRANSPARENT

	100 cm	150 cm	200 cm
CODICE CODE	10815T0113	10822T0113	10830T0113
CODICE CODE	10815T0213	10822T0213	10830T0213
CODICE CODE	10815T0313	10822T0313	10830T0313
CODICE CODE	10815T0413	10822T0413	10830T0413
CODICE CODE	10815T0813	10822T0813	10830T0813
CODICE CODE	10815T0913	10822T0913	10830T0913
CODICE CODE	10815T1013	10822T1013	10830T1013
CODICE CODE	10815T1413	10822T1413	10830T1413
CODICE CODE	10815T1513	10822T1513	10830T1513
CODICE CODE	10815T1613	10822T1613	10830T1613



“libertà progettuale”

MACROLUCE è una sospensione che lascia molta libertà progettuale. Le sue dimensioni ridotte abbinata alla tecnologia con diffusori in policarbonato arretrati, ci consentono di ridurre l'abbagliamento, rendendolo estremamente versatile e indispensabile da inserire in tutti gli spazi.

Macroluce is a suspension that leaves a lot of design freedom. Its dimensions combined with the technology with diffused polycarbonate set back, allow us to reduce glare, making it extremely versatile and indispensable to be inserted in all spaces.

MACROINLUCE utilizza sorgenti luminose a LED. Ha un corpo in alluminio estruso, diffusore in policarbonato ed è dotato di particolari accessori in metallo al fine di rendere questa lampada adatta a tutti gli ambienti di lavoro e privati.

MACROINLUCE uses LED lighting sources. It has an extruded aluminum body, polycarbonate diffuser and is specially metal accessories in order to make this lamp suitable in all work and private environments.

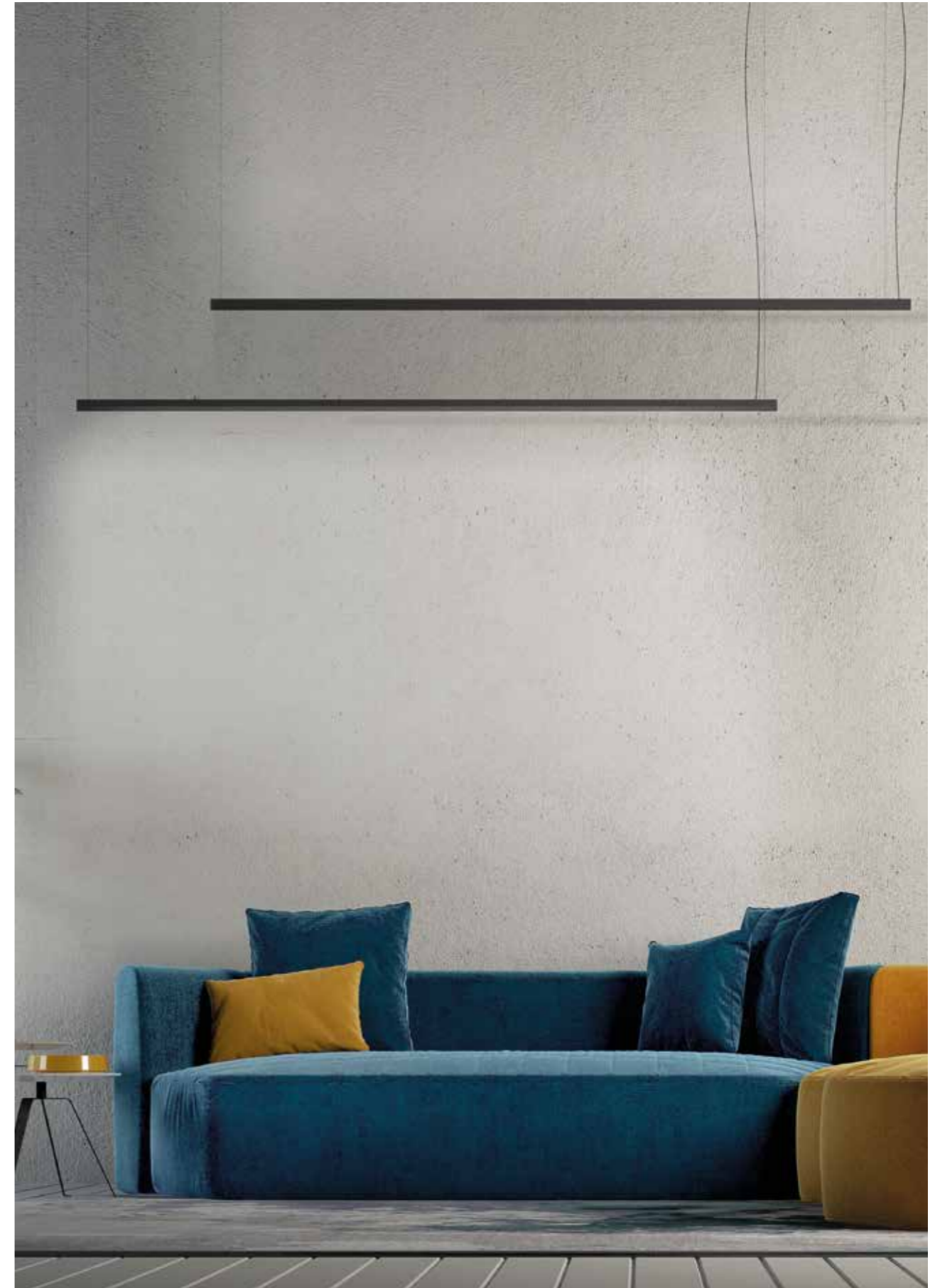

macroluce

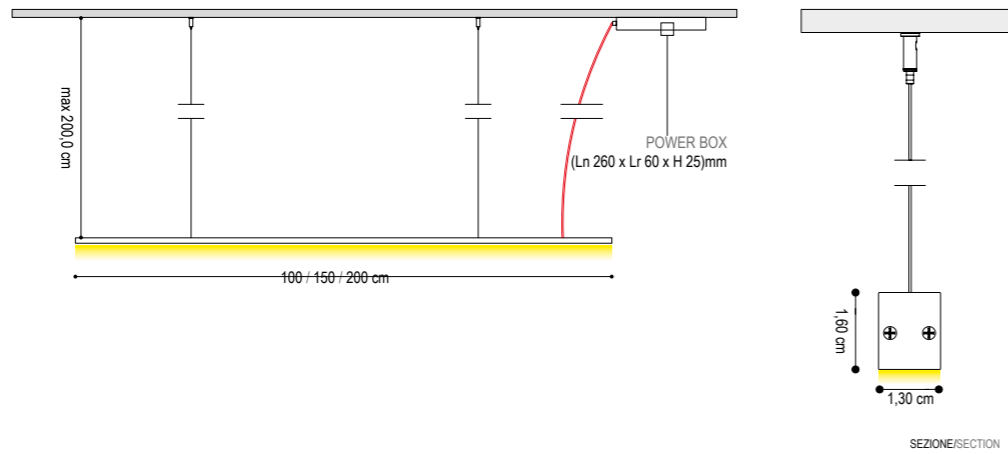
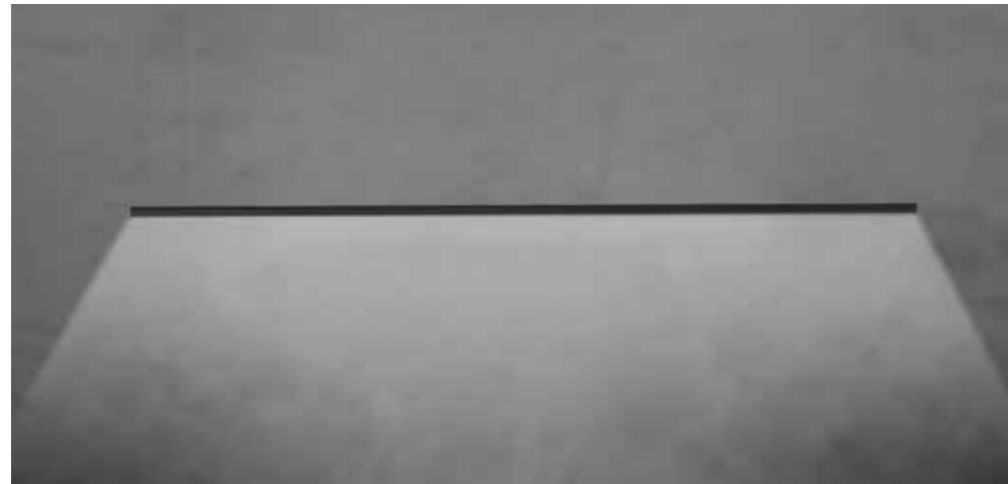

macroinluce

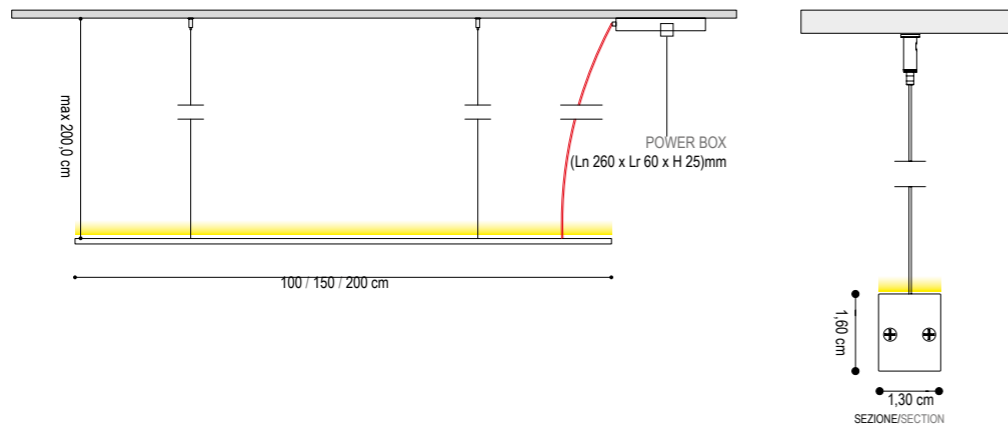
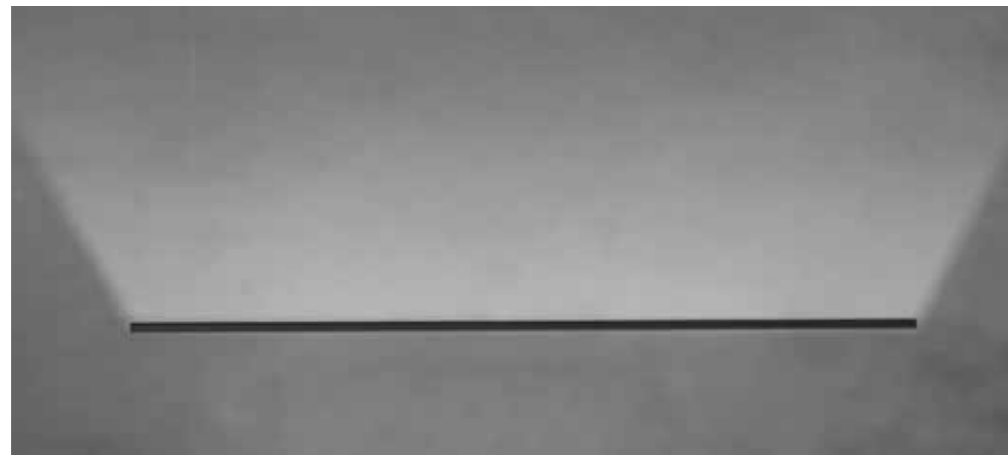

macroluce

scheda tecnica

BOX ON/OFF INCLUSO / INCLUDED

IL BOX IN DOTAZIONE È SEMPRE IN FINITURA BIANCO INTONACO. A RICHIESTA SI PUÒ ORDINARE NELLE ALTRE FINITURE A CATALOGO. THE BOX PROVIDED IS ALWAYS IN PLASTER WHITE FINISH. ON REQUEST YOU CAN HAVE OTHER CATALOG FINISHES.

ARTICOLI COMPRESI NEL CODICE: ITEMS INCLUDED IN THE CODE: CAVO ALIMENTAZIONE: 200 cm ALIMENTATION CABLE: 200 cm CAVI SOSPENSIONE IN ACCIAIO: 200 cm SUSPENSION CABLES IN STEEL: 200 cm

DATI TECNICI
TECHNICAL DATA

	100 cm	150 cm	200 cm
Nominal LED Flux:	1512 lm	2268 lm	3024 lm
Flux Tot:	1210 lm	1814 lm	2420 lm
Output:	105 lm/W	105 lm/W	105 lm/W
CCT:	3000 K	3000 K	3000 K
CRI:	>90	>90	>90
Power Tot:	15.0W	23.0W	30.0W
Weight:	0.65 Kg	0.95 Kg	1.25 Kg

Profilo/Profile: Alluminio/aluminum

Cover: Opale/opal

FINITURA STRUTTURA
FINISHES

- ARGILLA CLAY
- ARGENTO OPACO MATT SILVER
- BIANCO INTONACO/WHITE
- NERO CARAVAGGIO BLACK
- CROMO/CHROME
- ORO CALIFORNIA/GOLD
- ARAMEN COPPER
- TITANIO/TITANIUM
- BRONZO RIACI/RIACI BRONZE
- VERDE COSTA/GREEN COAST

COLORE CAVO
WIRE COLOR

TRASPARENTE
TRANSPARENT

	100 cm	150 cm	200 cm
CODICE CODE			
	10915T0103	10922T0103	10930T0103
	10915T0203	10922T0203	10930T0203
	10915T0303	10922T0303	10930T0303
	10915T0403	10922T0403	10930T0403
	10915T0803	10922T0803	10930T0803
	10915T0903	10922T0903	10930T0903
	10915T1003	10922T1003	10930T1003
	10915T1403	10920T1403	10930T1403
	10915T1503	10920T1503	10930T1503
	10915T1603	10920T1603	10930T1603

macroinluce

BOX ON/OFF INCLUSO / INCLUDED

IL BOX IN DOTAZIONE È SEMPRE IN FINITURA BIANCO INTONACO. A RICHIESTA SI PUÒ ORDINARE NELLE ALTRE FINITURE A CATALOGO. THE BOX PROVIDED IS ALWAYS IN PLASTER WHITE FINISH. ON REQUEST YOU CAN HAVE OTHER CATALOG FINISHES.

ARTICOLI COMPRESI NEL CODICE: ITEMS INCLUDED IN THE CODE: CAVO ALIMENTAZIONE: 200 cm ALIMENTATION CABLE: 200 cm CAVI SOSPENSIONE IN ACCIAIO: 200 cm SUSPENSION CABLES IN STEEL: 200 cm

DATI TECNICI
TECHNICAL DATA

	100 cm	150 cm	200 cm
Nominal LED Flux:	1520 lm	2280 lm	3040 lm
Flux Tot:	1295 lm	1942 lm	2590 lm
Output:	105 lm/W	105 lm/W	105 lm/W
CCT:	3000 K	3000 K	3000 K
CRI:	>90	>90	>90
Power Tot:	15.0W	23.0W	30.0W
Weight:	0.65 Kg	0.95 Kg	1.25 Kg

Profilo/Profile: Alluminio/aluminum

Cover: Opale/opal

FINITURA STRUTTURA
FINISHES

- ARGILLA CLAY
- ARGENTO OPACO MATT SILVER
- BIANCO INTONACO/WHITE
- NERO CARAVAGGIO BLACK
- CROMO/CHROME
- ORO CALIFORNIA/GOLD
- ARAMEN COPPER
- TITANIO/TITANIUM
- BRONZO RIACI/RIACI BRONZE
- VERDE COSTA/GREEN COAST

COLORE CAVO
WIRE COLOR

TRASPARENTE
TRANSPARENT

	100 cm	150 cm	200 cm
CODICE CODE			
	10915T0113	10922T0113	10930T0113
	10915T0213	10922T0213	10930T0213
	10915T0313	10922T0313	10930T0313
	10915T0413	10922T0413	10930T0413
	10915T0813	10922T0813	10930T0813
	10915T0913	10922T0913	10930T0913
	10915T1013	10922T1013	10930T1013
	10915T1413	10922T1413	10930T1413
	10915T1513	10922T1513	10930T1513
	10915T1613	10922T1613	10930T1613



“lama di luce”

METEORA è una sospensione elegante e adatta ad ambienti residenziali, ricettivi e commerciali. La sua ottica recessa consente di avere uno scenografico effetto a “lama di luce”. Coniuga in un design unico e minimale tutta la nostra esperienza nel settore delle ottiche e dell’illuminazione con sorgenti LED.

METEORA is an elegant suspension suitable for residential, reception and commercial environments. Its recessed optics allows you to have a scenographic “light blade” effect. It combines all our experience in the lighting field with LED sources.



meteora

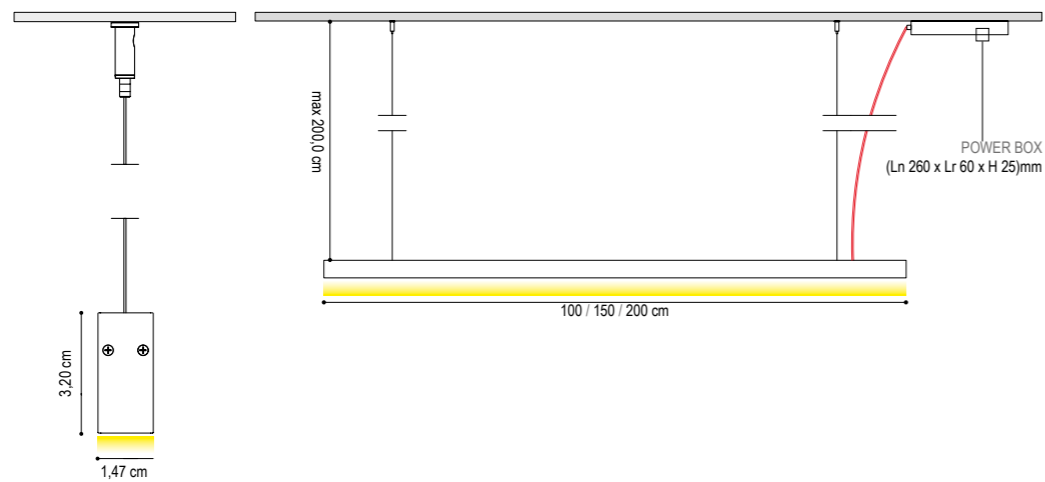

SEZIONE/SECTION

LA SOSPENSIONE METEORA È CARATTERIZZATA DALL'OTTICA ARRETRATA E DAL FASCIO DI LUCE STRETTO

METEORA SUSPENSION IS CHARACTERIZED BY THE BACKGROUND OPTIC AND THE NARROW BEAM



meteora



BOX ON/OFF INCLUSO / INCLUDED

IL BOX IN DOTAZIONE È SEMPRE IN FINITURA BIANCO INTONACO. A RICHIESTA SI PUÒ ORDINARE NELLE ALTRE FINITURE A CATALOGO. THE BOX PROVIDED IS ALWAYS IN PLASTER WHITE FINISH. ON REQUEST YOU CAN HAVE OTHER CATALOG FINISHES.

ARTICOLI COMPRESI NEL CODICE: ITEMS INCLUDED IN THE CODE: CAVO ALIMENTAZIONE: 200 cm ALIMENTATION CABLE: 200 cm CAVI SOSPENSIONE IN ACCIAIO: 200 cm SUSPENSION CABLES IN STEEL: 200 cm

UGR<19

scheda tecnica

DATI TECNICI
TECHNICAL DATA

	150 cm	200 cm
Nominal LED Flux:	2700 lm	3600 lm
Flux Tot:	2160 lm	2880 lm
Output:	150 lm/W	150 lm/W
CCT:	3000 K	3000 K
CRI:	>90	>90
Power Tot:	12.0W	24.0W
Weight:	1.00 Kg	2.00 Kg

Profilo/Profile: Alluminio/aluminum

Cover: Opale/opal

FINITURA STRUTTURA
FINISHES

COLORE CAVO
WIRE COLOR

- GRIGIO VESUVIO ANTHRACITE
- ARGILLA CLAY
- ARGENTO OPACO MATT SILVER
- BIANCO INTONACO/WHITE
- NERO CARAVAGGIO BLACK
- CROMO/CHROME
- ORO CALIFORNIA/GOLD
- ARAMEN COPPER
- GRIGIO AVIO GREY AVIO
- ARGENTO COMETA/SILVER COMET
- OTTONE VENEZIANO VENETIAN BRASS
- TITANIO/TITANIUM
- BRONZO RIACI/RIACI BRONZE
- VERDE COSTA/GREEN COAST
- TERRA SENESE SENESE EARTH

TRASPARENTE
TRANSPARENT

150 cm

200 cm

	CODICE 2700K CODE 2700K	CODICE 3000K CODE 3000K	CODICE 2700K CODE 2700K	CODICE 3000K CODE 3000K
	155400T150	155500T150	155400T200	155500T200
	155401T150	155501T150	155401T200	155501T200
	155402T150	155502T150	155402T200	155502T200
	155403T150	155503T150	155403T200	155503T200
	155404T150	155504T150	155404T200	155504T200
	155408T150	155508T150	155408T200	155508T200
	155409T150	155509T150	155409T200	155509T200
	155410T150	155510T150	155410T200	155510T200
	155411T150	155511T150	155411T200	155511T200
	155412T150	155512T150	155412T200	155512T200
	155413T150	155513T150	155413T200	155513T200
	155414T150	155514T150	155414T200	155514T200
	155415T150	155515T150	155415T200	155515T200
	155416T150	155516T150	155416T200	155516T200
	155417T150	155517T150	155417T200	155517T200



“moduli componibili, diverse combinazioni lineari”

PIVOT e MACRO PIVOT sono delle sospensioni composte di moduli componibili che ruotano sullo stesso asse e creano diverse combinazioni lineari. Gli elementi, ruotando, orientano la luce nell'ambiente: gli scenari di luce sono così modulabili da un'illuminazione generale indiretta al sotto-lineare geometrie spaziali degli interni con accenti di luce, anche grazie al supporto di lenti per il controllo dell'emissione luminosa. Il combinarsi dei moduli attorno ai perni dà luogo ad una famiglia di prodotti dalla lunghezza personalizzabile: lampada a sospensione, applique, piantana, braccio a parete studiato per applicazioni su aree di lavoro ed installazione cielo-terra.

PIVOT and MACRO PIVOT are a suspended lamps, composed with modules of different dimensions, arranged at the same high and it can be redirected at will. The modules can be oriented to create multiple light-atmospheres; upward, the lights create a relaxing atmosphere, downward, the user will be able to focus the beam more specifically on an activity. The PIVOT mechanism is adjustable in many different ways: it can be suspended from the ceiling, affixed to the wall or attached to a wall-mounted brackets. This makes an ideal lamp in both, office and home. ce in the lighting field with LED sources.

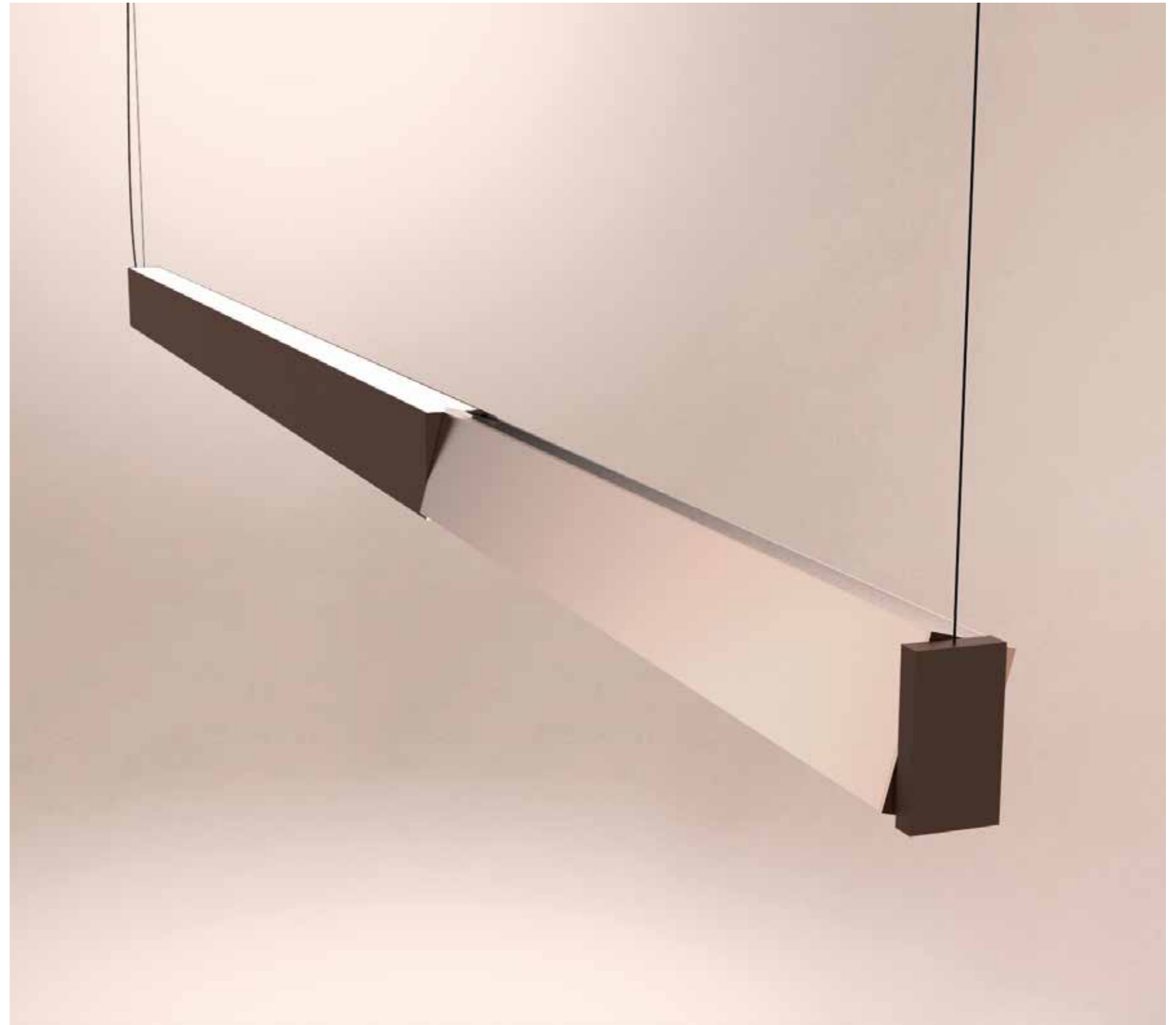

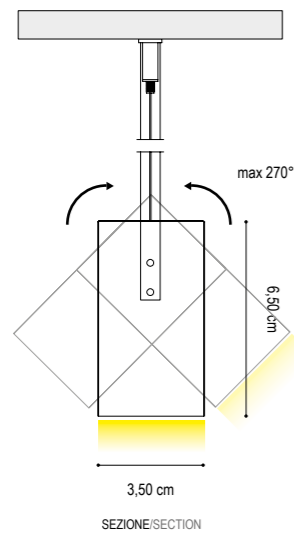
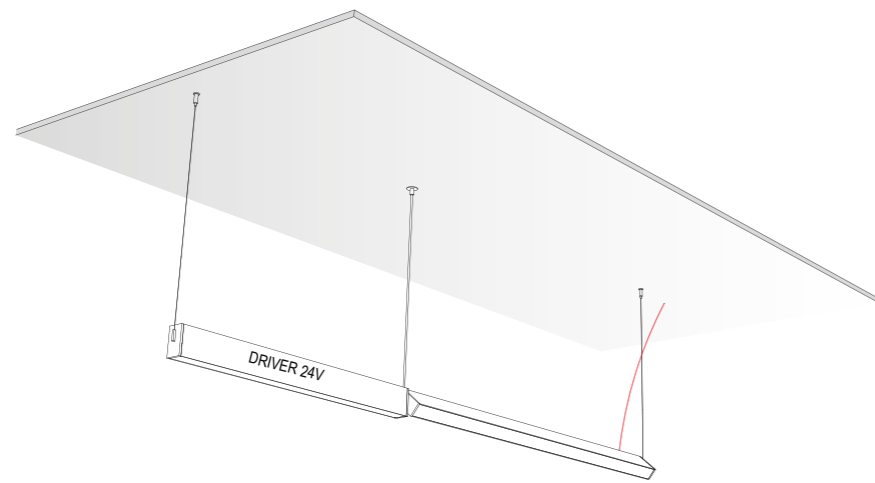

TUTTI I MODULI CHE COMPONGONO IL PIVOT SONO ORIENTABILI. LA ROTAZIONE MASSIMA CONSENTITA È DI 270° INTORNO AL PROPRIO ASSE ORIZZONTALE.
 ALL MODULES THAT MAKE UP THE PIVOT ARE ADJUSTABLE. THE MAXIMUM ALLOWED ROTATION IS 270 ° AROUND YOUR HORIZONTAL AXIS.

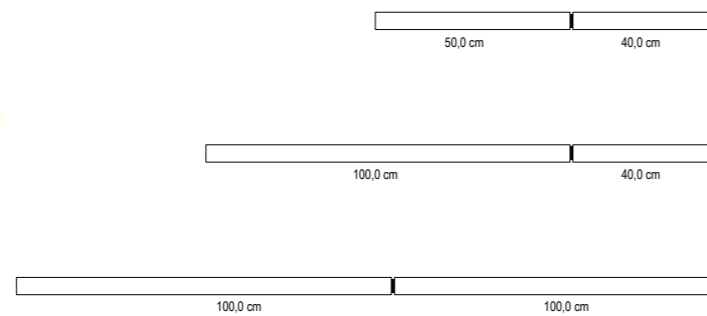

DRIVER ON/OFF INCLUSO / INCLUDED

IL BOX COPRIMORSETTO IN DOTAZIONE È SEMPRE IN FINITURA BIANCO INTONACO. A RICHIESTA SI PUÒ ORDINARE NELLE ALTRE FINITURE A CATALOGO.
 THE TERMINAL BOX PROVIDED IS ALWAYS IN PLASTER WHITE FINISH. ON REQUEST YOU CAN HAVE OTHER CATALOG FINISHES.

ARTICOLI COMPRESI NEL CODICE:
 ITEMS INCLUDED IN THE CODE:
 CAVO ALIMENTAZIONE: 200 cm
 ALIMENTATION CABLE: 200 cm
 CAVI SOSPENSIONE IN ACCIAIO: 200 cm
 SUSPENSION CABLES IN STEEL: 200 cm

DATI TECNICI
 TECHNICAL DATA

	90 cm (50cm + 40cm)	140 cm (100cm + 40cm)	200 cm (100cm + 100cm)
Nominal LED Flux:	1050 (50cm) / 840 (40cm) lm	2100 (100cm) / 840 (40cm) lm	2100 (100cm) / 2100 (100cm) lm
Flux Tot:	840 (50cm) / 672 (40cm) lm	1680 (100cm) / 672 (40cm) lm	1680 (100cm) / 1680 (100cm) lm
Output:	105 lm/W	105 lm/W	105 lm/W
CCT:	3000 K	3000 K	3000 K
CRI:	>90	>90	>90
Power:	10.0W (50cm) / 8.0W (40cm)	20.0W (100cm) / 8.0W (40cm)	20.0W (100cm) / 20.0W (100cm)
Power Tot:	18.0W	28.0W	40.0W
Weight:	1.80 Kg	2.10 Kg	2.80 Kg

Profilo/Profile: Alluminio/aluminum

Cover: Opale/opal

90 cm (50 cm + 40 cm) 140 cm (100 cm + 40 cm) 200 cm (100 cm + 100 cm)

FINITURA STRUTTURA FINISHES	COLORE CAVO WIRE COLOR	CODICE CODE	CODICE CODE	CODICE CODE
ARGILLA CLAY	BIANCO/WHITE	3018B01013	3028B01013	3040B01013
	NERO/BLACK	3018N01013	3028N01013	3040N01013
	BORDEAUX BORDEAUX	3018D01013	3028D01013	3040D01013
	TRASPARENTE/TRANSPARENT	3018T01013	3028T01013	3040T01013
ARGENTO OPACO/MATT SILVER	BORDEAUX BORDEAUX	3018D02013	3028D02013	3040D02013
	TRASPARENTE/TRANSPARENT	3018T02013	3028T02013	3040T02013
BIANCO INTONACO/WHITE	BIANCO/WHITE	3018B03013	3028B03013	3040B03013
	NERO/BLACK	3018N03013	3028N03013	3040N03013
	BORDEAUX BORDEAUX	3018D03013	3028D03013	3040D03013
	TRASPARENTE/TRANSPARENT	3018T03013	3028T03013	3040T03013
NERO CARAVAGGIO/BLACK	BIANCO/WHITE	3018B04013	3028B04013	3040B04013
	NERO/BLACK	3018N04013	3028N04013	3040N04013
	BORDEAUX BORDEAUX	3018D04013	3028D04013	3040D04013
	TRASPARENTE/TRANSPARENT	3018T04013	3028T04013	3040T04013
MOKA MOCHA	BIANCO/WHITE	3018B05013	3028B05013	3040B05013
	NERO/BLACK	3018N05013	3028N05013	3040N05013
	TRASPARENTE/TRANSPARENT	3018T05013	3028T05013	3040T05013
CROMO/CHROME	BORDEAUX BORDEAUX	3018D08013	3028D08013	3040D08013
	TRASPARENTE/TRANSPARENT	3018T08013	3028T08013	3040T08013
ORO CALIFORNIA/GOLD	BIANCO/WHITE	3018B09013	3028B09013	3040B09013
	NERO/BLACK	3018N09013	3028N09013	3040N09013
	TRASPARENTE/TRANSPARENT	3018T09013	3028T09013	3040T09013
ARAMEN COPPER	TRASPARENTE/TRANSPARENT	3018T10013	3028T10013	3040T10013
OTTONE VENEZIANO/BRASS	BIANCO/WHITE	3018B13013	3028B13013	3040B13013
	NERO/BLACK	3018N13013	3028N13013	3040N13013
	TRASPARENTE/TRANSPARENT	3018T13013	3028T13013	3040T13013
TITANIO/TITANIUM	TRASPARENTE/TRANSPARENT	3018T14013	3028T14013	3040T14013
BRONZO RIACI/RIACI BRONZE	TRASPARENTE/TRANSPARENT	3018T15013	3028T15013	3040T15013
VERDE COSTA/GREEN COAST	BIANCO/WHITE	3018B16013	3028B16013	3040B16013
	BORDEAUX BORDEAUX	3018D16013	3028D16013	3040D16013
	TRASPARENTE/TRANSPARENT	3018T16013	3028T16013	3040T16013





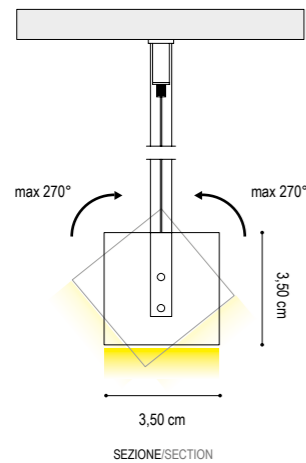
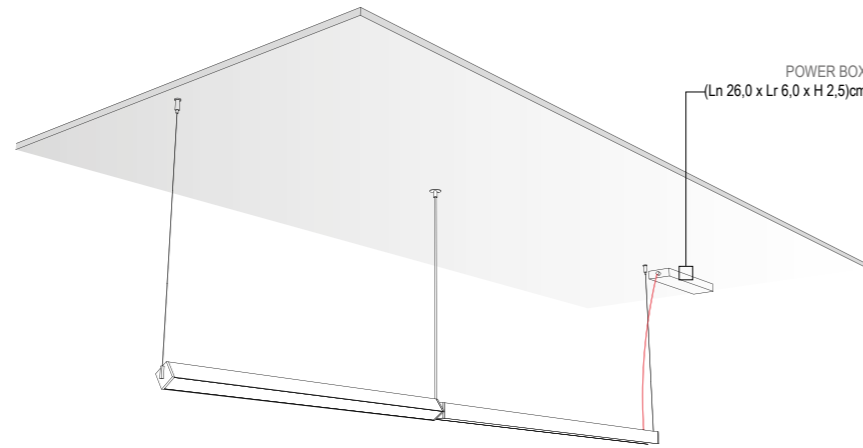

TUTTI I MODULI CHE COMPONGONO IL PIVOT SONO ORIENTABILI. LA ROTAZIONE MASSIMA CONSENTITA È DI 270° INTORNO AL PROPRIO ASSE ORIZZONTALE.
ALL MODULES THAT MAKE UP THE PIVOT ARE ADJUSTABLE. THE MAXIMUM ALLOWED ROTATION IS 270 ° AROUND YOUR HORIZONTAL AXIS.

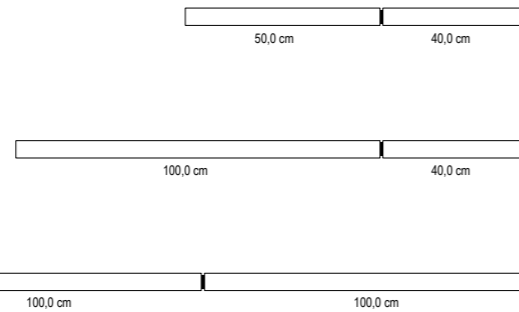

BOX ON/OFF INCLUSO / INCLUDED

IL BOX IN DOTAZIONE È SEMPRE IN FINITURA BIANCO INTONACO.
A RICHIESTA SI PUÒ ORDINARE NELLE ALTRE FINITURE A CATALOGO.
THE BOX PROVIDED IS ALWAYS IN PLASTER WHITE FINISH. ON REQUEST YOU CAN HAVE OTHER CATALOG FINISHES.

ARTICOLI COMPRESI NEL CODICE:
ITEMS INCLUDED IN THE CODE:
CAVO ALIMENTAZIONE: 200 cm
ALIMENTATION CABLE: 200 cm
CAVI SOSPENSIONE IN ACCIAIO: 200 cm
SUSPENSION CABLES IN STEEL: 200 cm

DATI TECNICI
TECHNICAL DATA

	90 cm (50cm + 40cm)	140 cm (100cm + 40cm)	200 cm (100cm + 100cm)
Nominal LED Flux:	1050 (50cm) / 840 (40cm) lm	2100 (100cm) / 840 (40cm) lm	2100 (100cm) / 2100 (100cm) lm
Flux Tot:	840 (50cm) / 672 (40cm) lm	1680 (100cm) / 672 (40cm) lm	1680 (100cm) / 1680 (100cm) lm
Output:	105 lm/W	105 lm/W	105 lm/W
CCT:	3000 K	3000 K	3000 K
CRI:	>90	>90	>90
Power:	10.0W (50cm) / 8.0W (40cm)	20.0W (100cm) / 8.0W (40cm)	20.0W (100cm) / 20.0W (100cm)
Power Tot:	18.0W	28.0W	40.0W
Weight:	1.80 Kg	2.10 Kg	2.80 Kg

Profilo/Profile: Alluminio/aluminum

Cover: Opale/opal

90 cm (50 cm + 40 cm) 140 cm (100 cm + 40 cm) 200 cm (100 cm + 100 cm)

FINITURA STRUTTURA FINISHES	COLORE CAVO WIRE COLOR	CODICE CODE	CODICE CODE	CODICE CODE
ARGILLA CLAY	BIANCO/WHITE	3118B01013	3128B01013	3136B01013
	NERO BLACK	3118N01013	3128N01013	3136N01013
	BORDEAUX BORDEAUX	3118D01013	3128D01013	3136D01013
	TRASPARENTE/TRANSPARENT	3118T01013	3128T01013	3136T01013
ARGENTO OPACO/MATT SILVER	BORDEAUX BORDEAUX	3118D02013	3128D02013	3136D02013
	TRASPARENTE/TRANSPARENT	3118T02013	3128T02013	3136T02013
BIANCO INTONACO/WHITE	BIANCO/WHITE	3118B03013	3128B03013	3136B03013
	NERO BLACK	3118N03013	3128N03013	3136N03013
	BORDEAUX BORDEAUX	3118D03013	3128D03013	3136D03013
	TRASPARENTE/TRANSPARENT	3118T03013	3128T03013	3136T03013
NERO CARAVAGGIO BLACK	BIANCO/WHITE	3118B04013	3128B04013	3136B04013
	NERO BLACK	3118N04013	3128N04013	3136N04013
	BORDEAUX BORDEAUX	3118D04013	3128D04013	3136D04013
	TRASPARENTE/TRANSPARENT	3118T04013	3128T04013	3136T04013
MOKA MOCHA	BIANCO/WHITE	3118B05013	3128B05013	3136B05013
	NERO BLACK	3118N05013	3128N05013	3136N05013
	TRASPARENTE/TRANSPARENT	3118T05013	3128T05013	3136T05013
CROMO/CHROME	BORDEAUX BORDEAUX	3118D08013	3128D08013	3136D08013
	TRASPARENTE/TRANSPARENT	3118T08013	3128T08013	3136T08013
ORO CALIFORNIA/GOLD	BIANCO/WHITE	3118B09013	3128B09013	3136B09013
	NERO BLACK	3118N09013	3128N09013	3136N09013
	TRASPARENTE/TRANSPARENT	3118T09013	3128T09013	3136T09013
ARAMEN COPPER	TRASPARENTE/TRANSPARENT	3118T10013	3128T10013	3136T10013
OTTONE VENEZIANO/BRASS	BIANCO/WHITE	3118B13013	3128B13013	3136B13013
	NERO BLACK	3118N13013	3128N13013	3136N13013
	TRASPARENTE/TRANSPARENT	3118T13013	3128T13013	3136T13013
TITANIO/TITANIUM	TRASPARENTE/TRANSPARENT	3118T14013	3128T14013	3136T14013
BRONZO RIACI/RIACI BRONZE	TRASPARENTE/TRANSPARENT	3118T15013	3128T15013	3136T15013



irid 22 - irid 33

**“luce a spot
per tutti gli attori del settore”**

IRID è l'inizio di una serie di progetti in cui si evince la ferma convinzione di design luce ad affrontare con decisione il tema della luce a Spot, offrendo a tutti gli attori del settore, Architetti, lighting, Ingegneri, non un solo prodotto, ma una gamma di soluzioni in cui i fasci luminosi per mezzo di gruppi ottici ne diventano i protagonisti. Ideali per il settore retail, ma anche per i musei o gallerie d'arte, dove la luce spesso viene chiamata ad assolvere compiti in cui è richiesta una qualità del comfort visivo alta.

IRID is the beginning of a series of projects in which the firm conviction of design light is evident in tackling the theme of light with decision at Spot, offering all the players in the sector, Architects, lighting, Engineers, not a single product, but a range of solutions in which the light beams do not become the protagonists by means of optical groups. Ideal for the retail sector, but also for museums or art galleries, where light is often called upon to perform tasks where a high quality of visual comfort is required.

irid 22 - irid 33

designer

luigi cerbone





Compatibile con i profili / Compatible with profiles

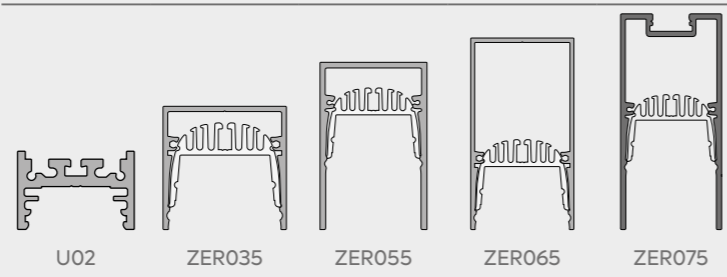

DATI TECNICI
TECHNICAL DATA

Flux Tot: 190 lm
Output: 112 lm/W
CCT: 3000K
CRI: 90
Power Tot: 1.7W / 700 mA
Fascio: 25°

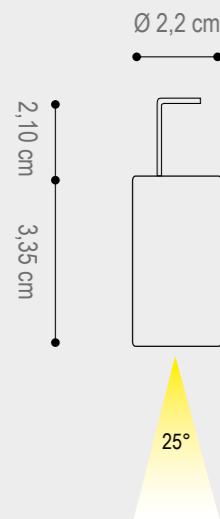

FINITURA FINISHES	CODICE 2700K CODE 2700K	CODICE 3000K CODE 3000K	CODICE 4000K CODE 4000K
GRIGIO VESUVIO ANTHRACITE	22C70024	22C80024	22C90024
ARGILLA CLAY	22C70124	22C80124	22C90124
BIANCO INTONACO/WHITE	22C70324	22C80324	22C90324
NERO CARAVAGGIO BLACK	22C70424	22C80424	22C90424
MOKA MOCHA	22C70524	22C80524	22C90524
CROMO/CHROME	22C70824	22C80824	22C90824
ORO CALIFORNIA/GOLD	22C70924	22C80924	22C90924
ARAMEN COPPER	22C71024	22C81024	22C91024
ARGENTO COMETA/SILVER COMET	22C71224	22C81224	22C91224
OTTONE VENEZIANO BRASS	22C71324	22C81324	22C91324
TITANIO/TITANIUM	22C71424	22C81424	22C91424
BRONZO RIACI/RIACI BRONZE	22C71524	22C81524	22C91524
VERDE COSTA/GREEN COAST	22C71624	22C81624	22C91624
TERRA SENESE SENESE EARTH	22C71724	22C81724	22C91724

DRIVER NON INCLUSO CONSULTA LA TABELLA DRIVER mA, PAG. 832-833

DATI TECNICI
TECHNICAL DATA

Flux Tot: 190lm
Output: 112 lm/W
CCT: 3000K
CRI: 90
Power Tot: 1.7W / 700 mA
Fascio: 35°

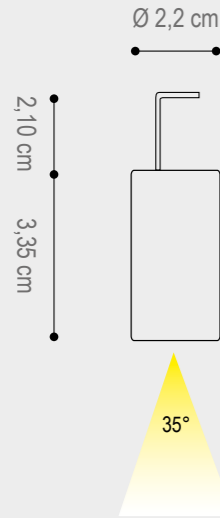

FINITURA FINISHES	CODICE 2700K CODE 2700K	CODICE 3000K CODE 3000K	CODICE 4000K CODE 4000K
GRIGIO VESUVIO ANTHRACITE	22C70036	22C80036	22C90036
ARGILLA CLAY	22C70136	22C80136	22C90136
BIANCO INTONACO/WHITE	22C70336	22C80336	22C90336
NERO CARAVAGGIO BLACK	22C70436	22C80436	22C90436
MOKA MOCHA	22C70536	22C80536	22C90536
CROMO/CHROME	22C70836	22C80836	22C90836
ORO CALIFORNIA/GOLD	22C70936	22C80936	22C90936
ARAMEN COPPER	22C71036	22C81036	22C91036
ARGENTO COMETA/SILVER COMET	22C71236	22C81236	22C91236
OTTONE VENEZIANO BRASS	22C71336	22C81336	22C91336
TITANIO/TITANIUM	22C71436	22C81436	22C91436
BRONZO RIACI/RIACI BRONZE	22C71536	22C81536	22C91536
VERDE COSTA/GREEN COAST	22C71636	22C81636	22C91636
TERRA SENESE SENESE EARTH	22C71736	22C81736	22C91736

DRIVER NON INCLUSO CONSULTA LA TABELLA DRIVER mA, PAG. 832-833



Compatibile con i profili / Compatible with profiles

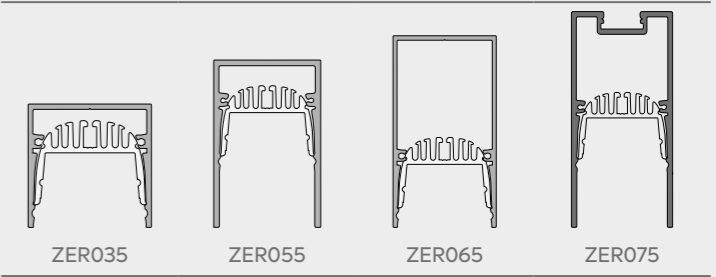

DATI TECNICI
TECHNICAL DATA

Flux Tot: 475 lm
Output: 95 lm/W
CCT: 3000K
CRI: 90
Power Tot: 5.0W / 700 mA
Fascio: 25°

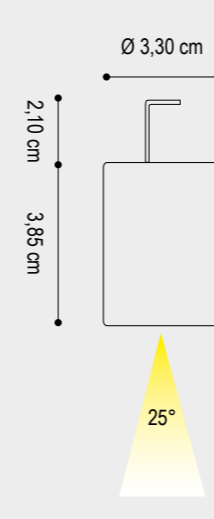

FINITURA FINISHES	CODICE 2700K CODE 2700K	CODICE 3000K CODE 3000K	CODICE 4000K CODE 4000K
GRIGIO VESUVIO ANTHRACITE	33CA0024	33CB0024	33CC0024
ARGILLA CLAY	33CA0124	33CB0124	33CC0124
BIANCO INTONACO/WHITE	33CA0324	33CB0324	33CC0324
NERO CARAVAGGIO BLACK	33CA0424	33CB0424	33CC0424
MOKA MOCHA	33CA0524	33CB0524	33CC0524
CROMO/CHROME	33CA0824	33CB0824	33CC0824
ORO CALIFORNIA/GOLD	33CA0924	33CB0924	33CC0924
ARAMEN COPPER	33CA1024	33CB1024	33CC1024
ARGENTO COMETA/SILVER COMET	33CA1224	33CB1224	33CC1224
OTTONE VENEZIANO BRASS	33CA1324	33CB1324	33CC1324
TITANIO/TITANIUM	33CA1424	33CB1424	33CC1424
BRONZO RIACI/RIACI BRONZE	33CA1524	33CB1524	33CC1524
VERDE COSTA/GREEN COAST	33CA1624	33CB1624	33CC1624
TERRA SENESE SENESE EARTH	33CA1724	33CB1724	33CC1724

DRIVER NON INCLUSO CONSULTA LA TABELLA DRIVER mA, PAG. 832-833

DATI TECNICI
TECHNICAL DATA

Flux Tot: 475 lm
Output: 95 lm/W
CCT: 3000K
CRI: 90
Power Tot: 5.0W / 700 mA
Fascio: 35°

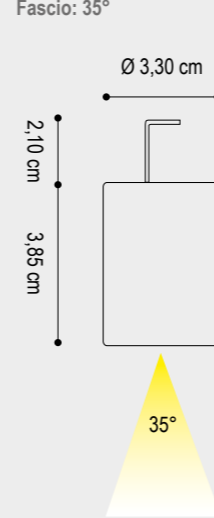

FINITURA FINISHES	CODICE 2700K CODE 2700K	CODICE 3000K CODE 3000K	CODICE 4000K CODE 4000K
GRIGIO VESUVIO ANTHRACITE	33CA0036	33CB0036	33CC0036
ARGILLA CLAY	33CA0136	33CB0136	33CC0136
BIANCO INTONACO/WHITE	33CA0336	33CB0336	33CC0336
NERO CARAVAGGIO BLACK	33CA0436	33CB0436	33CC0436
MOKA MOCHA	33CA0536	33CB0536	33CC0536
CROMO/CHROME	33CA0836	33CB0836	33CC0836
ORO CALIFORNIA/GOLD	33CA0936	33CB0936	33CC0936
ARAMEN COPPER	33CA1036	33CB1036	33CC1036
ARGENTO COMETA/SILVER COMET	33CA1236	33CB1236	33CC1236
OTTONE VENEZIANO BRASS	33CA1336	33CB1336	33CC1336
TITANIO/TITANIUM	33CA1436	33CB1436	33CC1436
BRONZO RIACI/RIACI BRONZE	33CA1536	33CB1536	33CC1536
VERDE COSTA/GREEN COAST	33CA1636	33CB1636	33CC1636
TERRA SENESE SENESE EARTH	33CA1736	33CB1736	33CC1736

DRIVER NON INCLUSO CONSULTA LA TABELLA DRIVER mA, PAG. 832-833



**“fasci luminosi che per mezzo
di gruppi ottici nè diventano i protagonisti”**

TRIS è l'inizio di una serie di progetti in cui si evince la ferma convinzione di design luce ad affrontare con decisione il tema della luce a Spot, offrendo a tutti gli attori del settore, Architetti, lighting, Ingegneri, non un solo prodotto, ma una gamma di soluzioni in cui i fasci luminosi per mezzo di gruppi ottici nè diventano i protagonisti. Ideali per il settore retail, ma anche per i musei o gallerie d'arti, dove la luce spesso viene chiamata ad assolvere compiti in cui è richiesta una qualità del comfort visivo alta.

TRIS is the beginning of a series of projects in which the firm conviction of design light is evident in tackling the theme of light with decision at Spot, offering all the players in the sector, Architects, lighting, Engineers, not a single product, but a range of solutions in which the light beams do not become the protagonists by means of optical groups. Ideal for the retail sector, but also for museums or art galleries, where light is often called upon to perform tasks where a high quality of visual comfort is required.



Compatibile con il profilo / Compatible with profiles

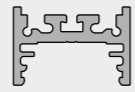

U02

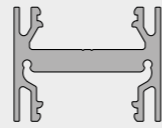

structurae

DATI TECNICI
TECHNICAL DATA

Flux Tot: 660 lm
Output: 105 lm/W
CCT: 3000K
CRI: 90
LENS Power Tot: 6.3W 700mA
Fascio: 25°

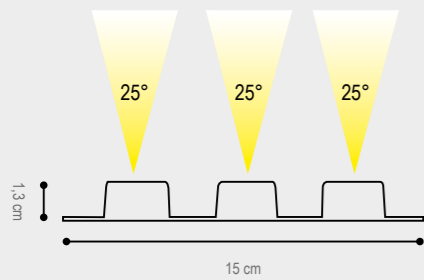

DRIVER NON INCLUSO CONSULTA LA TABELLA DRIVER mA, PAG. 832-833

FINITURA
FINISHES

- GRIGIO VESUVIO ANTHRACITE
- ARGILLA CLAY
- ARGENTO OPACO MATT SILVER
- BIANCO INTONACO/WHITE
- NERO CARAVAGGIO BLACK
- MOKA MOCHA
- CROMO/CHROME
- ORO CALIFORNIA/GOLD
- ARAMEN COPPER
- GRIGIO AVIO GREY AVIO
- ARGENTO COMETA/SILVER COMET
- OTTONE VENEZIANO BRASS
- TITANIO/TITANIUM
- BRONZO RIACI/RIACI BRONZE
- VERDE COSTA/GREEN COAST
- TERRA SENESE SENESE EARTH

CODICE 2700K CODE 2700K	CODICE 3000K CODE 3000K	CODICE 4000K CODE 4000K
26F20025	26F30025	26F40025
26F20125	26F30125	26F40125
26F20225	26F30225	26F40225
26F20325	26F30325	26F40325
26F20425	26F30425	26F40425
26F20525	26F30525	26F40525
26F20825	26F30825	26F40825
26F20925	26F30925	26F40925
26F21025	26F31025	26F41025
26F21125	26F31125	26F41125
26F21225	26F31225	26F41225
26F21325	26F31325	26F41325
26F21425	26F31425	26F41425
26F21525	26F31525	26F41525
26F21625	26F31625	26F41625
26F21725	26F31725	26F41725

DATI TECNICI
TECHNICAL DATA

Flux Tot: 660 lm
Output: 105 lm/W
CCT: 3000K
CRI: 90
LENS Power Tot: 6.3W 700mA
Fascio: 40°

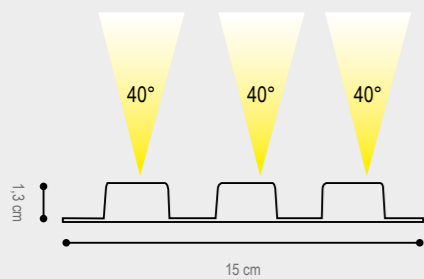

DRIVER NON INCLUSO CONSULTA LA TABELLA DRIVER mA, PAG. 832-833

FINITURA
FINISHES

- GRIGIO VESUVIO ANTHRACITE
- ARGILLA CLAY
- ARGENTO OPACO MATT SILVER
- BIANCO INTONACO/WHITE
- NERO CARAVAGGIO BLACK
- MOKA MOCHA
- CROMO/CHROME
- ORO CALIFORNIA/GOLD
- ARAMEN COPPER
- GRIGIO AVIO GREY AVIO
- ARGENTO COMETA/SILVER COMET
- OTTONE VENEZIANO BRASS
- TITANIO/TITANIUM
- BRONZO RIACI/RIACI BRONZE
- VERDE COSTA/GREEN COAST
- TERRA SENESE SENESE EARTH

CODICE 2700K CODE 2700K	CODICE 3000K CODE 3000K	CODICE 4000K CODE 4000K
26F20040	26F30040	26F40040
26F20140	26F30140	26F40140
26F20240	26F30240	26F40240
26F20340	26F30340	26F40340
26F20440	26F30440	26F40440
26F20540	26F30540	26F40540
26F20840	26F30840	26F40840
26F20940	26F30940	26F40940
26F21040	26F31040	26F41040
26F21140	26F31140	26F41140
26F21240	26F31240	26F41240
26F21340	26F31340	26F41340
26F21440	26F31440	26F41440
26F21540	26F31540	26F41540
26F21640	26F31640	26F41640
26F21740	26F31740	26F41740



Compatibile con i profili / Compatible with profiles

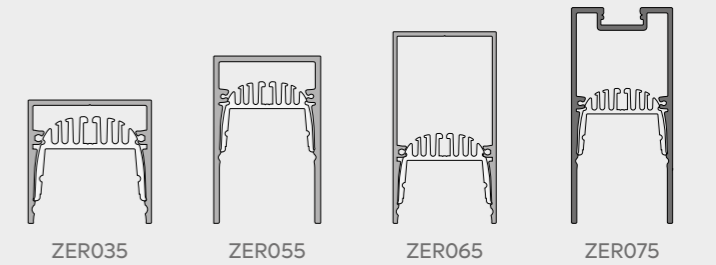

ZERO35

ZERO55

ZERO65

ZERO75

DATI TECNICI
TECHNICAL DATA

Flux Tot: 660 lm
Output: 105 lm/W
CCT: 3000K
CRI: 90
LENS Power Tot: 6.3W 700mA
Fascio: 25°

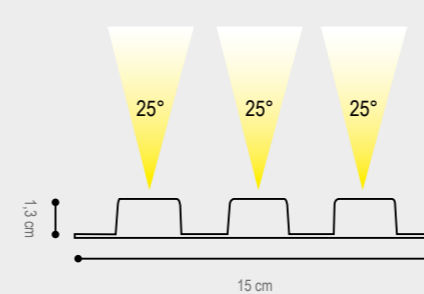

DRIVER NON INCLUSO CONSULTA LA TABELLA DRIVER mA, PAG. 832-833

FINITURA
FINISHES

- GRIGIO VESUVIO ANTHRACITE
- ARGILLA CLAY
- ARGENTO OPACO MATT SILVER
- BIANCO INTONACO/WHITE
- NERO CARAVAGGIO BLACK
- MOKA MOCHA
- CROMO/CHROME
- ORO CALIFORNIA/GOLD
- ARAMEN COPPER
- GRIGIO AVIO GREY AVIO
- ARGENTO COMETA/SILVER COMET
- OTTONE VENEZIANO BRASS
- TITANIO/TITANIUM
- BRONZO RIACI/RIACI BRONZE
- VERDE COSTA/GREEN COAST
- TERRA SENESE SENESE EARTH

CODICE 2700K CODE 2700K	CODICE 3000K CODE 3000K	CODICE 4000K CODE 4000K
55F20025	55F30025	55F40025
55F20125	55F30125	55F40125
55F20225	55F30225	55F40225
55F20325	55F30325	55F40325
55F20425	55F30425	55F40425
55F20525	55F30525	55F40525
55F20825	55F30825	55F40825
55F20925	55F30925	55F40925
55F21025	55F31025	55F41025
55F21125	55F31125	55F41125
55F21225	55F31225	55F41225
55F21325	55F31325	55F41325
55F21425	55F31425	55F41425
55F21525	55F31525	55F41525
55F21625	55F31625	55F41625
55F21725	55F31725	55F41725

DATI TECNICI
TECHNICAL DATA

Flux Tot: 660 lm
Output: 105 lm/W
CCT: 3000K
CRI: 90
LENS Power Tot: 6.3W 700mA
Fascio: 40°

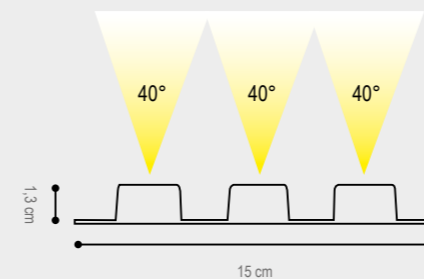

DRIVER NON INCLUSO CONSULTA LA TABELLA DRIVER mA, PAG. 832-833

FINITURA
FINISHES

- GRIGIO VESUVIO ANTHRACITE
- ARGILLA CLAY
- ARGENTO OPACO MATT SILVER
- BIANCO INTONACO/WHITE
- NERO CARAVAGGIO BLACK
- MOKA MOCHA
- CROMO/CHROME
- ORO CALIFORNIA/GOLD
- ARAMEN COPPER
- GRIGIO AVIO GREY AVIO
- ARGENTO COMETA/SILVER COMET
- OTTONE VENEZIANO BRASS
- TITANIO/TITANIUM
- BRONZO RIACI/RIACI BRONZE
- VERDE COSTA/GREEN COAST
- TERRA SENESE SENESE EARTH

CODICE 2700K CODE 2700K	CODICE 3000K CODE 3000K	CODICE 4000K CODE 4000K
55F20040	55F30040	55F40040
55F20140	55F30140	55F40140
55F20240	55F30240	55F40240
55F20340	55F30340	55F40340
55F20440	55F30440	55F40440
55F20540	55F30540	55F40540
55F20840	55F30840	55F40840
55F20940	55F30940	55F40940
55F21040	55F31040	55F41040
55F21140	55F31140	55F41140
55F21240	55F31240	55F41240
55F21340	55F31340	55F41340
55F21440	55F31440	55F41440
55F21540	55F31540	55F41540
55F21640	55F31640	55F41640
55F21740	55F31740	55F41740



orbita	262
davinci	266
pivot – w	270
mini pivot – w	274
j	278
float	282
eco	288
infinito	292
mancorrente	296
tryten	300

“elisse come orbite”

ORBITA prosegue il progetto di Design Luce iniziato con OLIMPIA. L'ellisse è la naturale conseguenza del cerchio, una forma armonica che richiama le orbite che i corpi celesti descrivono intorno al Sole.

ORBITA racchiude in sé tutta l'eleganza e la leggerezza di una lampada LED dagli elevati contenuti tecnici ed illuminotecnici.

ORBITA continues the Design Luce project started with OLIMPIA. The ellipse is a natural consequence of the circle, a harmonic form which recalls the orbit of celestial bodies. Around the sun. ORBITA embodies the elegance and lightness of a LED lamp with very high technical contents.



orbita

customizzazione

customization

Amin = 120,00 cm / Amax = 220,00 cm
Bmin = 60,00 cm / Bmax = 110,00 cm

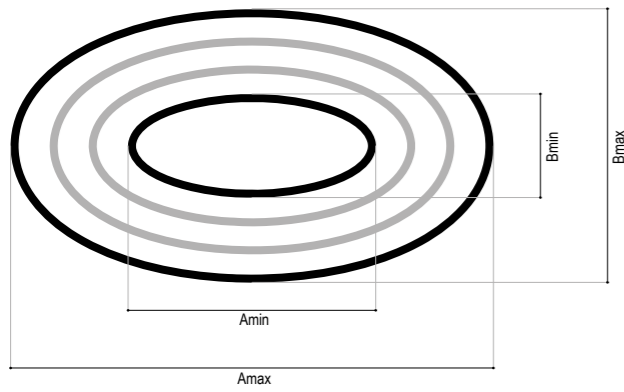

Il prodotto verrà fornito come unica ellisse
The product will be supplied as a single ellipse

A > 220,00 cm
B > 110,00 cm

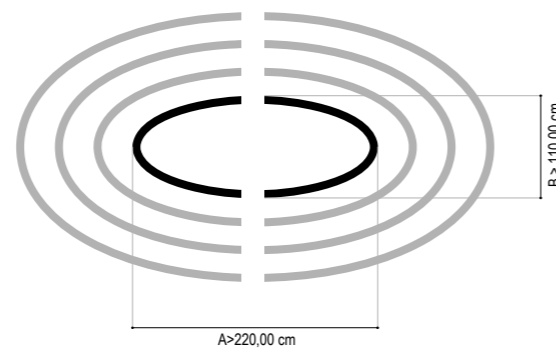

Il prodotto verrà fornito in più archi di ellisse da giuntare
The product will be supplied in several ellipse arcs to be joined



scheda tecnica

orbita

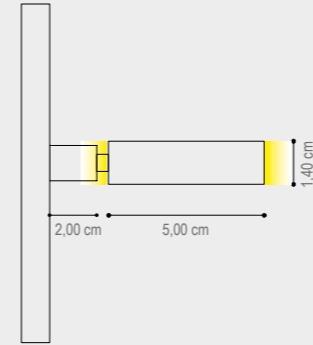

SEZIONE PROFILO/PROFILE SECTION

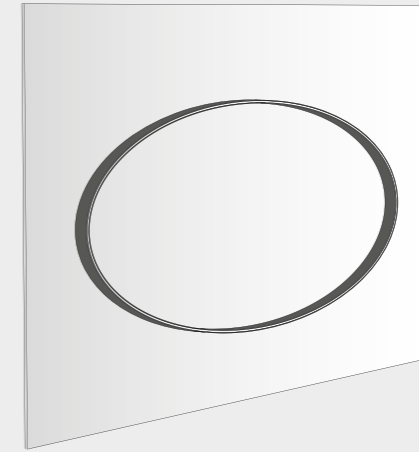

ORBITA CON DRIVER REMOTO
ORBITA WITH REMOTE POWER SUPPLY



DATI TECNICI
TECHNICAL DATA

DRIVER 24V ON/OFF INCLUSO
PER INSTALLAZIONE IN REMOTO
DRIVER 24V ON/OFF INCLUDED
FOR REMOTE INSTALLATION

SUPPORTI FISSAGGIO PARETE INCLUSI
WALL MOUNTING SUPPORTS INCLUDED

CAVO ALIMENTAZIONE: 50 cm
ALIMENTATION CABLE: 50 cm

	COMPOSIZIONE A1 120 cm / 60 cm	COMPOSIZIONE A2 160 cm / 80 cm
Nominal LED Flux:	↑ 3655 lm - 3655 lm ↓	↑ 4845 lm - 4845 lm ↓
Flux Tot:	↑ 2924 lm - 2924 lm ↓	↑ 3876 lm - 3876 lm ↓
Output:	85 lm/W	85 lm/W
CCT:	3000 K	3000 K
CRI:	>90	>90
Power:	↑ 43.0W - 43.0W ↓	↑ 57.0W - 57.0W ↓
Power Tot:	86.0W	114.0W
Weight:	3.60 Kg	2.50 Kg
Profilo/Profile: Alluminio/aluminum		Cover: Satinata/satin

FINITURA STRUTTURA
FINISHES

- BIANCO INTONACO/WHITE
- NERO CARAVAGGIO BLACK
- ORO CALIFORNIA/GOLD
- ARAMEN COPPER
- GRIGIO AVIO GREY AVIO
- ARGENTO COMETA/SILVER COMET
- OTTONE VENEZIANO VENETIAN BRASS

	COMPOSIZIONE P1 120 cm / 60 cm	COMPOSIZIONE P2 160 cm / 80 cm
CODICE CODE	405503P1	405503P2
	405504P1	405504P2
	405509P1	405509P2
	405510P1	405510P2
	405511P1	405511P2
	405512P1	405512P2
	405513P1	405513P2

ATTENZIONE/PLEASE NOTE: SU RICHIESTA COMPOSIZIONI CUSTOM / CUSTOM COMPOSITIONS ON REQUEST

SERIE OLIMPIA / ALTIS / ORBITA:
SI CONSIGLIA DI NON SUPERARE UNA DISTANZA TRA L'ALIMENTATORE E IL CORPO ILLUMINANTE DI 10,00 m CON UNA SEZIONE DI CAVO DI 1,50 mmq

OLIMPIA / ALTIS / ORBITA SERIES:
WE RECOMMEND NOT TO EXCEED A DISTANCE BETWEEN DRIVER AND THE LIGHTING BODY OF 10.00 m WITH A CABLE SECTION OF 1.50 mmq



“accattivante ed estremamente versatile”

DAVINCI è stato disegnato per offrire agli architetti un prodotto flessibile e in linea con i migliori sistemi tecnologici. Il posizionamento dei gruppi ottici contribuiscono a ridurre l'abbagliamento e al recupero dell'efficienza illuminotecnica, rendendolo accattivante ed estremamente versatile. Viene proposto nella versione sospensione con luce diretta/indiretta e a soffitto con luce diretta. Il suo design è decisamente minimale e le sue eleganti finiture gli consentono di essere inserito in tutti gli ambienti architettonici.

DAVINCI has been design to offer a flexible product in line with the best technological systems. The positioning of the optical groups contributes to reduce every glare and recover lighting efficiency, making it attractive and extremely attractive. It's proposed in the suspended version with direct/indirect light and in the ceiling version with direct light. Its design is minimal and its elegant finishes allow it to be put in all architectural environments.



davinci



davinci

scheda tecnica

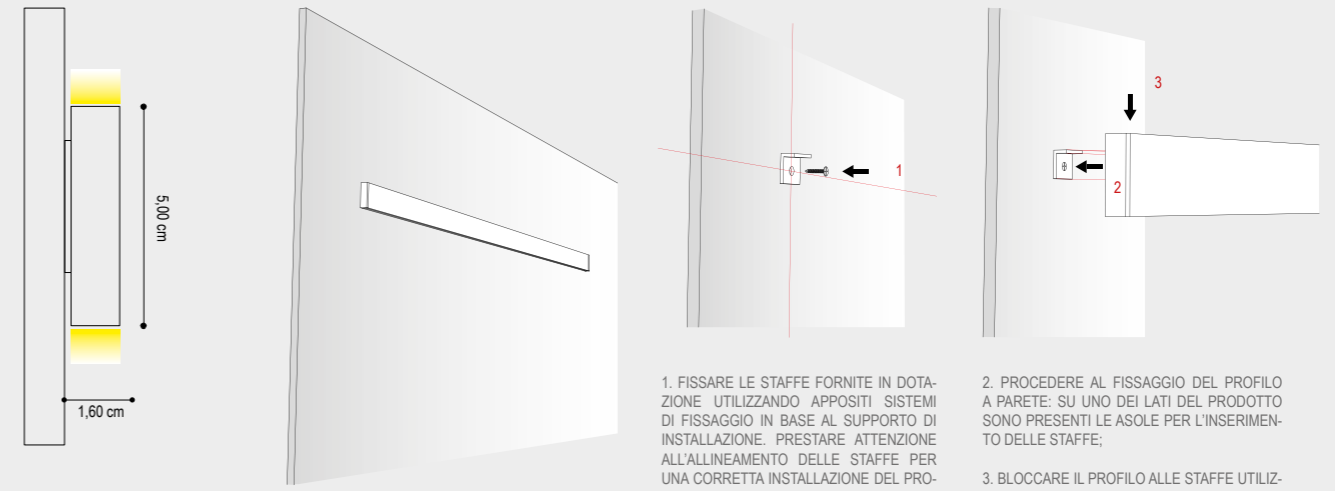

SEZIONE PROFILO/PROFILE SECTION

DAVINCI CON DRIVER REMOTO
DAVINCI WITH REMOTE DRIVER

1. FISSARE LE STAFFE FORNITE IN DOTAZIONE UTILIZZANDO APPOSITI SISTEMI DI FISSAGGIO IN BASE AL SUPPORTO DI INSTALLAZIONE. PRESTARE ATTENZIONE ALL'ALLINEAMENTO DELLE STAFFE PER UNA CORRETTA INSTALLAZIONE DEL PRODOTTO.
1. FIX THE SUPPLIED BRACKETS PROVIDED USING SPECIAL FIXING SYSTEMS ON THE BASIS OF THE INSTALLATION SUPPORT. PAY ATTENTION TO THE ALIGNMENT OF THE BRACKETS FOR A CORRECT INSTALLATION OF THE PRODUCT.

2. PROCEDERE AL FISSAGGIO DEL PROFILO A PARETE: SU UNO DEI LATI DEL PRODOTTO SONO PRESENTI LE ASOLE PER L'INSERIMENTO DELLE STAFFE;
2. PROCEED TO FIX THE WALL PROFILE: ON ONE OF THE SIDES OF THE PRODUCT THERE ARE SLOTS FOR INSERTING THE BRACKETS;

3. BLOCCARE IL PROFILO ALLE STAFFE UTILIZZANDO LE APPOSITE VITI IN DOTAZIONE.
3. LOCK THE PROFILE TO THE BRACKETS USING THE SPECIAL SCREWS PROVIDED.



DRIVER ON/OFF NON INCLUSO/ NOT INCLUDED

STAFFE FISSAGGIO APPLIQUE INCLUSE
WALL MOUNTING BRACKETS INCLUDED

CAVO ALIMENTAZIONE: 50 cm
ALIMENTATION CABLE: 50 cm

DATI TECNICI
TECHNICAL DATA

	150 cm	200 cm
Nominal LED Flux:	↑2700 lm - 5400 lm ↓	↑3600 lm - 7200 lm ↓
Flux Tot:	↑2160 lm - 4320 lm ↓	↑2880 lm - 5760 lm ↓
Output:	150 lm/W	150 lm/W
CCT:	3000 K	3000 K
CRI:	>90	>90
Power:	↑18.0W - 36.0W ↓	↑24.0W - 48.0W ↓
Power Tot:	54.0W	72.0W
Weight:	1.42 Kg	1.90 Kg

Profilo/Profile: Alluminio/aluminum

Cover: Satinata/satin

FINITURA STRUTTURA
FINISHES

- GRIGIO VESUVIO ANTHRACITE
- ARGILLA CLAY
- BIANCO INTONACO/WHITE
- NERO CARAVAGGIO BLACK
- ORO CALIFORNIA/GOLD
- ARAMEN COPPER
- GRIGIO AVIO GREY AVIO
- ARGENTO COMETA/SILVER COMET
- OTTONE VENEZIANO VENETIAN BRASS
- TITANIO/TITANIUM
- BRONZO RIACI/RIACI BRONZE
- TERRA SENESE SENESE EARTH
- CROMO/CHROME

COLORE CAVO
WIRE COLOR

- TRASPARENTE
TRANSPARENT
- ACCIAIO
STEEL

150 cm

200 cm

CODICE 2700K CODE 2700K	CODICE 3000K CODE 3000K	CODICE 2700K CODE 2700K	CODICE 3000K CODE 3000K
405400P150	405500P150	405400P200	405500P200
405401P150	405501P150	405401P200	405501P200
405403P150	405503P150	405403P200	405503P200
405404P150	405504P150	405404P200	405504P200
405409P150	405509P150	405409P200	405509P200
405410P150	405510P150	405410P200	405510P200
405411P150	405511P150	405411P200	405511P200
405412P150	405512P150	405412P200	405512P200
405413P150	405513P150	405413P200	405513P200
405414P150	405514P150	405414P200	405514P200
405415P150	405515P150	405415P200	405515P200
405417P150	405517P150	405417P200	405517P200
405408P150	405508P150	405408P200	405508P200



**“moduli componibili,
diverse combinazioni lineari”**

PIVOT-W e MINI PIVOT-W sono delle sospensioni composte da moduli componibili che ruotano sullo stesso asse e creano diverse combinazioni lineari. Gli elementi, ruotando, orientano la luce nell'ambiente: gli scenari di luce sono così modulabili da un'illuminazione generale indiretta al sottolineare geometrie spaziali degli interni con accenti di luce, anche grazie al supporto di lenti per il controllo dell'emissione luminosa. Il combinarsi dei moduli attorno ai perni dà luogo ad una famiglia di prodotti dalla lunghezza personalizzabile: lampada a sospensione, applique, piantana, braccio a parete studiato per applicazioni su aree di lavoro ed installazione cielo-terra.

PIVOT-W and MINI PIVOT-W are a suspended lamps, composed with modules of different dimensions, arranged at the same high and it can be redirected at will. The modules can be oriented to create multiple light-atmospheres; upward, the lights create a relaxing atmosphere, downward, the user will be able to focus the beam more specifically on an activity. The PIVOT mechanism is adjustable in many different ways: it can be suspended from the ceiling, affixed to the wall or attached to a wall-mounted brackets. This makes an ideal lamp in both, office and home. ce in the lighting field with LED sources.



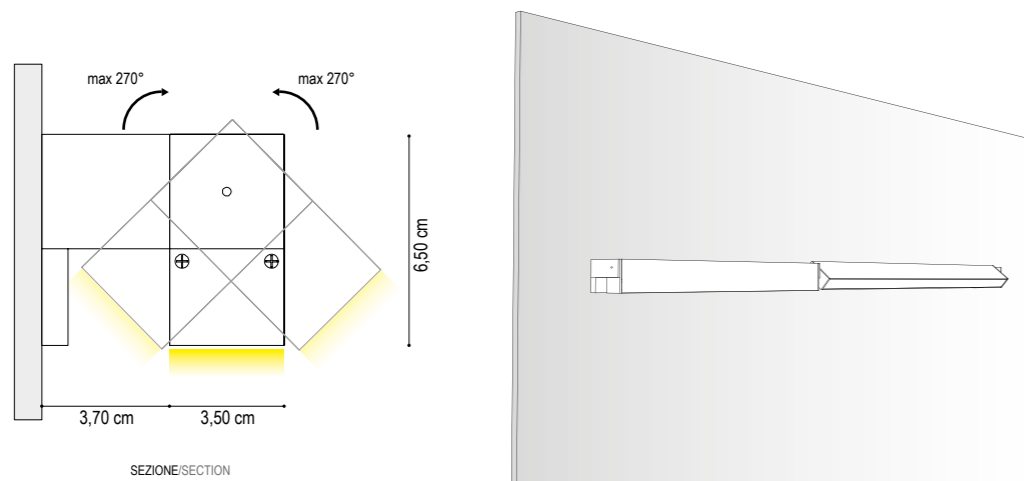

TUTTI I MODULI CHE COMPONGONO IL PIVOT-W SONO ORIENTABILI.
 LA ROTAZIONE MASSIMA CONSENTITA È DI 270° INTORNO AL PROPRIO ASSE ORIZZONTALE.
 ALL MODULES THAT MAKE UP THE PIVOT-W ARE ADJUSTABLE.
 THE MAXIMUM ALLOWED ROTATION IS 270 ° AROUND YOUR HORIZONTAL AXIS.

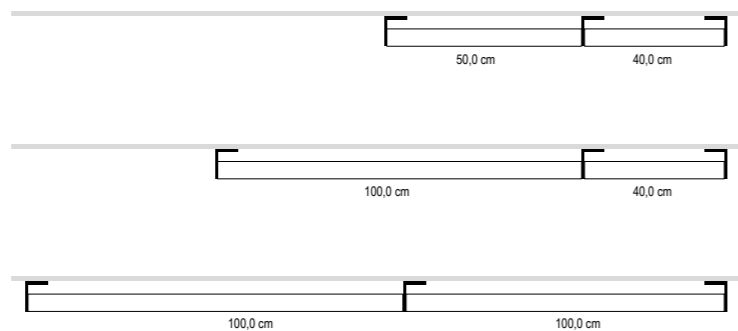

DATI TECNICI
 TECHNICAL DATA

	90 cm (50 cm + 40cm)	140 cm (100 cm + 40 cm)	200 cm (100 cm + 100 cm)
Nominal LED Flux:	1890 lm	2940 lm	4200 lm
Flux Tot:	1512 lm	2352 lm	3360 lm
Output:	105 lm/W	105 lm/W	105 lm/W
CCT:	3000 K	3000 K	3000 K
CRI:	>90	>90	>90
Power:	10.0W (50cm) + 8.0W (40cm)	20.0W (100cm) + 8.0W (40cm)	20.0W (100cm) + 20.0W (100cm)
Power Tot:	18.0W	28.0W	40.0W
Weight:	1.20 Kg	1.60 Kg	2.40 Kg

Profilo/Profile: Alluminio/aluminum Cover: Opale/opal

 DRIVER 24V ON/OFF INCLUSO / INCLUDED
 NO POWER BOX
 LUNGHEZZA CAVO ALIMENTAZIONE: 50 cm
 ALIMENTATION CABLE LENGTH: 50 cm

FINITURA STRUTTURA FINISHES	DIFFUSORE DIFFUSER	90 cm (50 cm + 40 cm)	140 cm (100 cm + 40 cm)	200 cm (100 cm + 100 cm)
		CODICE CODE	CODICE CODE	CODICE CODE
GRIGIO VESUVIO ANTHRACITE	OPALE/OPAL	304700A090	304700A140	304700A200
ARGILLA CLAY		304701A090	304701A140	304701A200
ARGENTO OPACO/MATT SILVER		304702A090	304702A140	304702A200
BIANCO INTONACO/WHITE		304703A090	304703A140	304703A200
NERO CARAVAGGIO BLACK		304704A090	304704A140	304704A200
MOKA MOCHA		304705A090	304705A140	304705A200
CROMO CHROME		304708A090	304708A140	304708A200
ORO CALIFORNIA/GOLD		304709A090	304709A140	304709A200
ARAMEN COPPER		304710A090	304710A140	304710A200
GRIGIO AVIO GREY AVIO		304711A090	304711A140	304711A200
OTTONE VENEZIANO/VENETIAN BRASS		304713A090	304713A140	304713A200
TITANIO/TITANIUM		304714A090	304714A140	304714A200
BRONZO RIACI/RIACI BRONZE		304715A090	304715A140	304715A200
VERDE COSTA/GREEN COAST		304716A090	304716A140	304716A200
TERRA SENESE SENESE EARTH		304717A090	304717A140	304717A200



mini pivot - w

mini pivot - w

designer

luigi cerbone



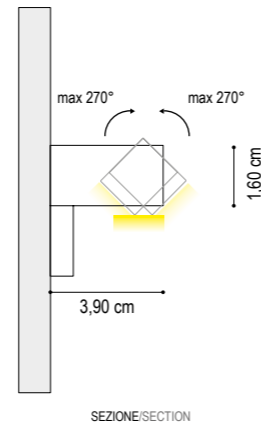

TUTTI I MODULI CHE COMPONGONO IL MINI PIVOT-W SONO ORIENTABILI. LA ROTAZIONE MASSIMA CONSENTITA È DI 270° INTORNO AL PROPRIO ASSE ORIZZONTALE.
ALL MODULES THAT MAKE UP THE MINI PIVOT-W ARE ADJUSTABLE. THE MAXIMUM ALLOWED ROTATION IS 270 ° AROUND YOUR HORIZONTAL AXIS.

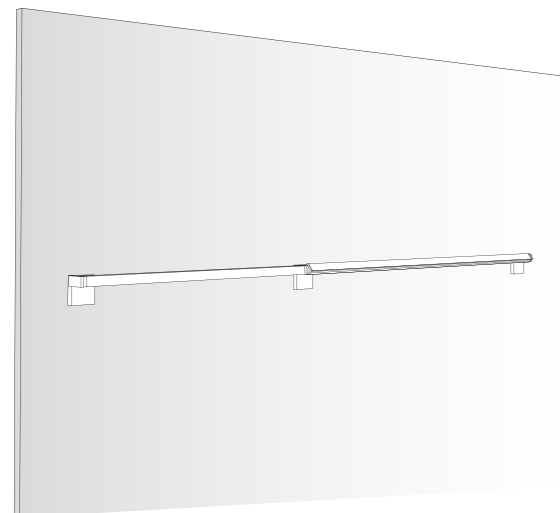

DATI TECNICI
TECHNICAL DATA

	90 cm	140 cm	200 cm
Nominal LED Flux:	1650 lm	2550 lm	3600 lm
Flux Tot:	1320 lm	2040 lm	2880 lm
Output:	150 lm/W	150 lm/W	150 lm/W
CCT:	3000 K	3000 K	3000 K
CRI:	>90	>90	>90
Power:	6.0W (50cm) + 5.0W (40cm)	12.0W (100cm) + 5.0W (40cm)	12.0W (100cm) + 12.0W (100cm)
Power Tot:	11.0W	17.0W	24.0W
Weight:	0.80 Kg	1.10 Kg	1.90 Kg
Profilo/Profile:	Alluminio/aluminum		Cover: Opale/opal

 DRIVER 24V ON/OFF INCLUSO / INCLUDED
NO POWER BOX
LUNGHEZZA CAVO ALIMENTAZIONE: 50 cm
ALIMENTATION CABLE LENGTH: 50 cm

FINITURA STRUTTURA FINISHES	DIFFUSORE DIFFUSER	90 cm (50 cm + 40 cm)	140 cm (100 cm + 40 cm)	200 cm (100 cm + 100 cm)
		CODICE CODE	CODICE CODE	CODICE CODE
GRIGIO VESUVIO ANTHRACITE	OPALE/OPAL	315500B090	315500B140	315500B200
ARGILLA CLAY		315501B090	315501B140	315501B200
BIANCO INTONACO/WHITE		315503B090	315503B140	315503B200
NERO CARAVAGGIO/BLACK		315504B090	315504B140	315504B200
MOKA MOCHA		315505B090	315505B140	315505B200
CROMO/CHROME		315508B090	315508B140	315508B200
ORO CALIFORNIA/GOLD		315509B090	315509B140	315509B200
ARAMEN COPPER		315510B090	315510B140	315510B200
OTTONE VENEZIANO/VENETIAN BRASS		315513B090	315513B140	315513B200
TITANIO/TITANIUM		315514B090	315514B140	315514B200
BRONZO RIACI/RIACI BRONZE		315515B090	315515B140	315515B200
VERDE COSTA/GREEN COAST		315516B090	315516B140	315516B200

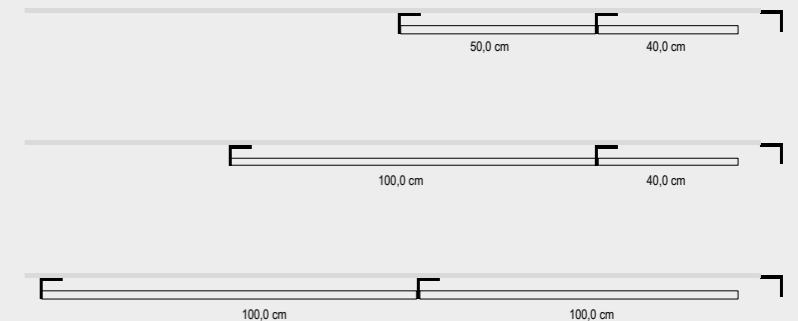

**“è l’armoniosa proporzione di una
forma semplice abbinata alla tecnologia LED”**

J è l’armoniosa proporzione di una forma semplice abbinata alla tecnologia LED. J progettato per ottenere fino a tre flussi luminosi indipendenti. È possibile integrarlo con fascio di luce a colori nella versione RGB. Il suo design sobrio ed accattivante permette agli architetti di creare delle scenografie luminose capaci di valorizzare gli spazi architettonici.

J is the harmonious proportion of a simple shape combined with LED technology. J designed to obtain up to three independent luminous fluxes. It can be integrated with a color light beam in the RGB version. Its sober and captivating design allows architects to create luminous scenographies capable of enhancing architectural spaces.





DRIVER 24V NON INCLUSO / NOT INCLUDED

LUNGHEZZA CAVO ALIMENTAZIONE: 50 cm
ALIMENTATION CABLE LENGTH: 50 cm

N.B. NON È POSSIBILE ORDINARE IL PRODOTTO SENZA ALIMENTATORE
PLEASE NOTE! IT IS NOT POSSIBLE TO ORDER THE PRODUCT WITHOUT THE POWER SUPPLY

DATI TECNICI
TECHNICAL DATA

	1 cm - 60W/m	1 cm - 40W/m + RGB 15W/m
Nominal LED Flux:	↑ 2100 lm/m - ↑ 2100 lm/m - 2100 lm/m ↓	↑ 2100 lm/m - ↑ RGB - 2100 lm/m ↓
Flux Tot:	↑ 1680 lm/m - ↑ 1680 lm/m - 1680 lm/m ↓	↑ 1680 lm/m - ↑ RGB - 1680 lm/m ↓
Output:	105 lm/W	105 lm/W
CCT:	3000 K	3000 K
CRI:	>90	>90
Power:	↑ 20.0W/m - ↑ 20.0W/m - 20.0W/m ↓	↑ 20.0W/m - ↑ RGB15W/m - 20.0W/m ↓
Power Tot:	60.0W/m	55.0W/m
Weight:	1.20 Kg	1.20 Kg

Profilo/Profile: Alluminio/aluminum

Cover: Opale/opal

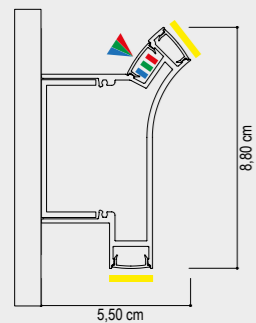
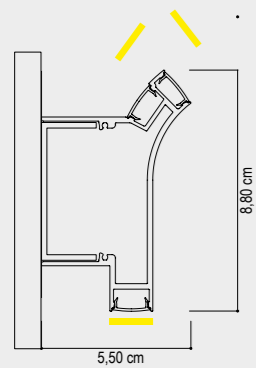
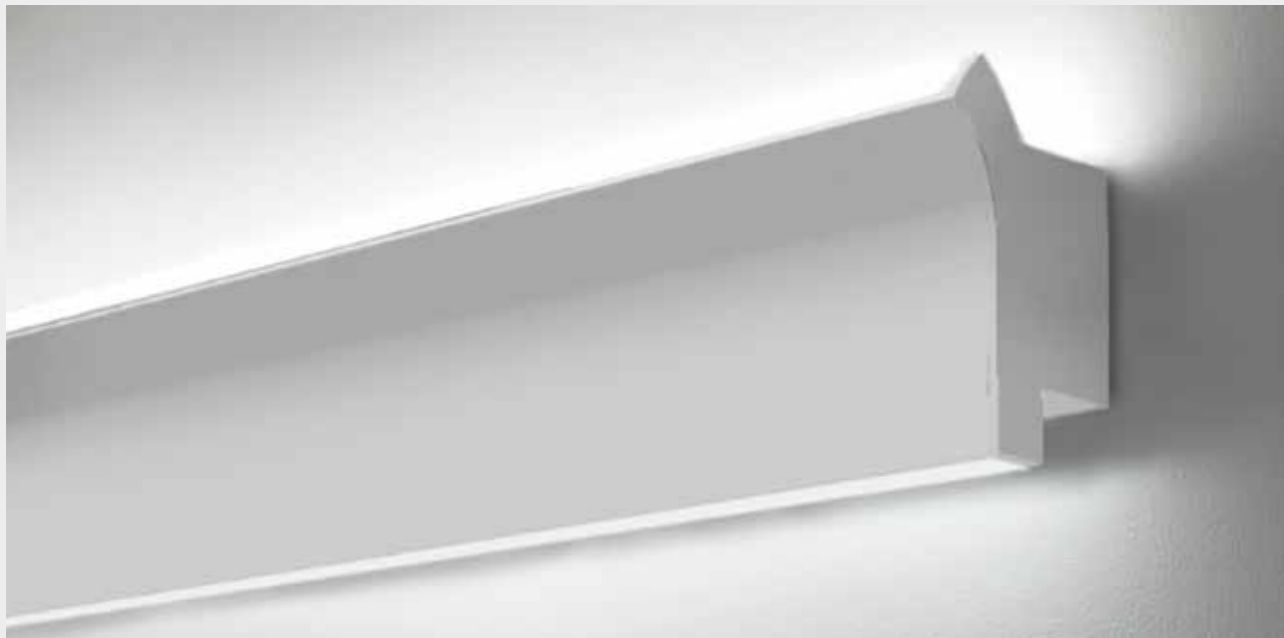

FINITURA STRUTTURA
FINISHES

- GRIGIO VESUVIO ANTHRACITE
- ARGILLA CLAY
- BIANCO INTONACO/WHITE
- NERO CARAVAGGIO BLACK
- MOKA MOCHA
- CROMO/CHROME
- ORO CALIFORNIA/GOLD
- ARAMEN COPPER
- GRIGIO AVIO/ GREY AVIO
- ARGENTO COMETA/SILVER COMET
- OTTONE VENEZIANO/ VENETIAN BRASS
- TITANIO/TITANIUM
- BRONZO RIACI/RIACI BRONZE
- VERDE COSTA/GREEN COAST
- TERRA SENESE SENESE EARTH

DIFFUSORE
DIFFUSER

OPALE/OPAL

1 cm - 60W/m

1 cm - 40W/m + RGB 15W/m

CODICE CODE	CODICE CODE
2620000001	2699000001
2620010001	2699010001
2620030001	2699030001
2620040001	2699040001
2620050001	2699050001
2620080001	2699080001
2620090001	2699090001
2620100001	2699100001
2620110001	2699110001
2620120001	2699120001
2620130001	2699130001
2620140001	2699140001
2620150001	2699150001
2620160001	2699160001
2620170001	2699170001

TESTATE DI CHIUSURA / DEAD ENDS

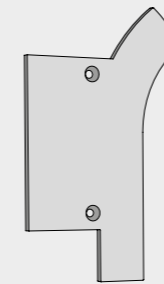

FINITURA STRUTTURA
FINISHES

- GRIGIO VESUVIO ANTHRACITE
- ARGILLA CLAY
- BIANCO INTONACO/WHITE
- NERO CARAVAGGIO BLACK
- MOKA MOCHA
- CROMO/CHROME
- ORO CALIFORNIA/GOLD
- ARAMEN COPPER

CODICE
CODE

- 260400
- 260401
- 260403
- 260404
- 260405
- 260408
- 260409
- 260410

FINITURA STRUTTURA
FINISHES

- GRIGIO AVIO/ GREY AVIO
- ARGENTO COMETA/SILVER COMET
- OTTONE VENEZIANO/ VENETIAN BRASS
- TITANIO/TITANIUM
- BRONZO RIACI/RIACI BRONZE
- VERDE COSTA/GREEN COAST
- TERRA SENESE SENESE EARTH

CODICE
CODE

- 260411
- 260412
- 260413
- 260414
- 260415
- 260416
- 260417

N.B. Il codice contiene n° 2 testate di chiusura / The code contains 2 closing dead ends

CABLAGGIO DRIVER CE
DRIVER CE WIRING



MONTAGGIO CABLAGGIO COLLAUDO CE DRIVER DIM 120W / MOUNTING WIRING TESTING CE MARKING DRIVER DIM 120W
MONTAGGIO CABLAGGIO COLLAUDO CE DRIVER DIM 150W / MOUNTING WIRING TESTING CE MARKING DRIVER DIM 150W

CODICE
CODE

1120D
1150D



**“un prodotto,
tre configurazioni,
infinite personalizzazioni”**

Un prodotto, tre configurazioni, infinite personalizzazioni. FLOAT spicca nel DNA di Design Luce: creare prodotti che si plasmano nei progetti illuminotecnici rendendoli eleganti armoniosi e contribuendone ad esaltarne le architetture. FLOAT è stato equipaggiato con le ultime tecnologie led, senza trascurare la regolazione luminosa in grado di diffondere con estrema efficienza la qualità della luce richiesta.

A product with three configurations, infinite customizations. FLOAT stands out in the DNA of Design Luce: to create products that are molded in lighting projects, making them elegant, harmonious and contributing to enhancing their architecture. FLOAT has been equipped with the latest LED technology, without neglecting the luminous regulation able to diffuse the required light quality with extreme efficiency.



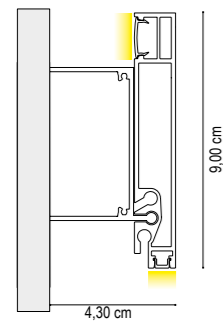

FLOAT I
LED MONOCOLORE

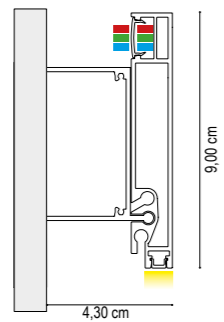

FLOAT I
LED MONOCOLORE + RGB

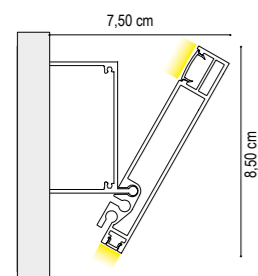

FLOAT K
LED MONOCOLORE

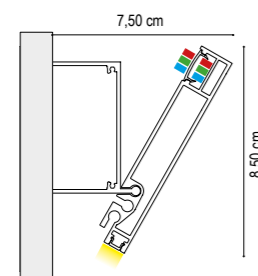

FLOAT K
LED MONOCOLORE + RGB

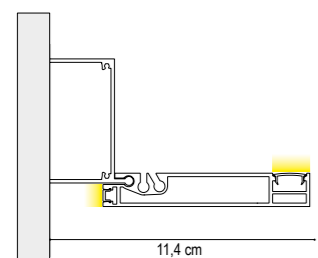

FLOAT L
LED MONOCOLORE

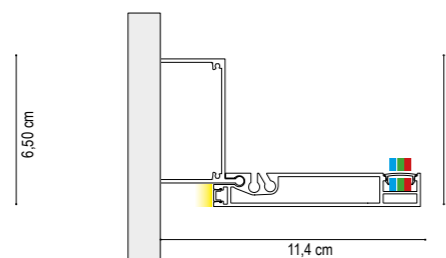

FLOAT L
LED MONOCOLORE + RGB



DRIVER 24V NON INCLUSO / NOT INCLUDED

LUNGHEZZA CAVO ALIMENTAZIONE: 50 cm
ALIMENTATION CABLE LENGTH: 50 cm

N.B. NON È POSSIBILE ORDINARE IL PRODOTTO SENZA ALIMENTATORE
PLEASE NOTE! IT IS NOT POSSIBLE TO ORDER THE PRODUCT WITHOUT THE POWER SUPPLY

DATI TECNICI
TECHNICAL DATA

	1 cm - 35W/m	1 cm - 15W/m + RGB
Nominal LED Flux:	↑ 2100 lm/m - 1224 lm/m ↓	↑ RGB - 1224 lm/m ↓
Flux Tot:	↑ 1680 lm/m - 980 lm/m ↓	↑ RGB - 980 lm/m ↓
Output:	↑ 105 lm/m - 85 lm/m ↓	↑ RGB - 85 lm/m ↓
CCT:	3000 K	3000 K
CRI:	>90	>90
Power:	↑ 20.0W/m - 15.0W/m ↓	↑ RGB 15W/m - 15.0W/m ↓
Power Tot:	35.0W/m	30.0W/m
Weight:	1.50 Kg/m	1.50 Kg/m

Profilo/Profile: Alluminio/aluminum

Cover: Opale/opal

FINITURA STRUTTURA
FINISHES

GRIGIO VESUVIO ANTHRACITE
ARGILLA CLAY
BIANCO INTONACO/WHITE
NERO CARAVAGGIO BLACK
MOKA MOCHA
CROMO/CHROME
ORO CALIFORNIA/GOLD
ARAMEN COPPER
ARGENTO COMETA/SILVER COMET
TITANIO/TITANIUM
BRONZO RIACI/RIACI BRONZE
VERDE COSTA/GREEN COAST

DIFFUSORE
DIFFUSER

OPALE/OPAL

1 cm - 35W/m

1 cm - 15W/m + RGB 15W/m

CODICE
CODE

2714I00001
2714I01001
2714I03001
2714I04001
2714I05001
2714I08001
2714I09001
2714I10001
2714I12001
2714I14001
2714I15001
2714I16001

CODICE
CODE

2799I00001
2799I01001
2799I03001
2799I04001
2799I05001
2799I08001
2799I09001
2799I10001
2799I12001
2799I14001
2799I15001
2799I16001

TESTATE DI CHIUSURA / DEAD ENDS

FINITURA STRUTTURA FINISHES	CODICE CODE	FINITURA STRUTTURA FINISHES	CODICE CODE
GRIGIO VESUVIO ANTHRACITE	270400	ORO CALIFORNIA/GOLD	270409
ARGILLA CLAY	270401	ARAMEN COPPER	270410
BIANCO INTONACO/WHITE	270403	ARGENTO COMETA/SILVER COMET	270412
NERO CARAVAGGIO BLACK	270404	TITANIO/TITANIUM	270414
MOKA MOCHA	270405	BRONZO RIACI/RIACI BRONZE	270415
CROMO/CHROME	270408	VERDE COSTA/GREEN COAST	270416

N.B. Il codice contiene n° 2 testate di chiusura / The code contains 2 closing dead ends

CABLAGGIO DRIVER CE
DRIVER CE WIRING

	CODICE CODE
MONTAGGIO CABLAGGIO COLLAUDO CE DRIVER 60W / MOUNTING WIRING TESTING CE MARKING DRIVER 60W	1050A
MONTAGGIO CABLAGGIO COLLAUDO CE DRIVER 96W / MOUNTING WIRING TESTING CE MARKING DRIVER 96W	1096A
MONTAGGIO CABLAGGIO COLLAUDO CE DRIVER DIM 70W / MOUNTING WIRING TESTING CE MARKING DIM DRIVER 70W	1070D
MONTAGGIO CABLAGGIO COLLAUDO CE DRIVER DIM 100W / MOUNTING WIRING TESTING CE MARKING DRIVER DIM 100W	1101D
MONTAGGIO CABLAGGIO COLLAUDO CE DRIVER DIM 120W / MOUNTING WIRING TESTING CE MARKING DRIVER DIM 120W	1120D
MONTAGGIO CABLAGGIO COLLAUDO CE DRIVER DIM 150W / MOUNTING WIRING TESTING CE MARKING DRIVER DIM 150W	1150D



float k

scheda tecnica



DRIVER 24V NON INCLUSO / NOT INCLUDED

LUNGHEZZA CAVO ALIMENTAZIONE: 50 cm
ALIMENTATION CABLE LENGTH: 50 cm

N.B. NON È POSSIBILE ORDINARE IL PRODOTTO SENZA ALIMENTATORE
N.B. IT IS NOT POSSIBLE TO ORDER THE PRODUCT WITHOUT THE POWER SUPPLY

DATI TECNICI
TECHNICAL DATA

	1 cm - 35W/m	1 cm - 15W/m + RGB
Nominal LED Flux:	↑ 2100 lm/m - 1224 lm/m ↓	↑ RGB - 1224 lm/m ↓
Flux Tot:	↑ 1680 lm/m - 980 lm/m ↓	↑ RGB - 980 lm/m ↓
Output:	↑ 105 lm/m - 85 lm/m ↓	↑ RGB - 85 lm/m ↓
CCT:	3000 K	3000 K
CRI:	>90	>90
Power:	↑ 20.0W/m - 15.0W/m ↓	↑ RGB15W/m - 15.0W/m ↓
Power Tot:	35.0W/m	30.0W/m
Weight:	1.50 Kg/m	1.50 Kg/m
Profilo/Profile:	Alluminio/aluminum	Cover: Opale/opal

FINITURA STRUTTURA
FINISHES

GRIGIO VESUVIO ANTHRACITE
ARGILLA CLAY
BIANCO INTONACO/WHITE
NERO CARAVAGGIO BLACK
MOKA MOCHA
CROMO/CHROME
ORO CALIFORNIA/GOLD
ARAMEN COPPER
ARGENTO COMETA/SILVER COMET
TITANIO/TITANIUM
BRONZO RIACI/RIACI BRONZE
VERDE COSTA/GREEN COAST

DIFFUSORE
DIFFUSER

OPALE/OPAL

1 cm - 35W/m

CODICE CODE
2714K00001
2714K01001
2714K03001
2714K04001
2714K05001
2714K08001
2714K09001
2714K10001
2714K12001
2714K14001
2714K15001
2714K16001

1 cm - 15W/m + RGB 15W/m

CODICE CODE
2799K00001
2799K01001
2799K03001
2799K04001
2799K05001
2799K08001
2799K09001
2799K10001
2799K12001
2799K14001
2799K15001
2799K16001

TESTATE DI CHIUSURA / DEAD ENDS

FINITURA STRUTTURA FINISHES	CODICE CODE	FINITURA STRUTTURA FINISHES	CODICE CODE
GRIGIO VESUVIO ANTHRACITE	270400	ORO CALIFORNIA/GOLD	270409
ARGILLA CLAY	270401	ARAMEN COPPER	270410
BIANCO INTONACO/WHITE	270403	ARGENTO COMETA/SILVER COMET	270412
NERO CARAVAGGIO BLACK	270404	TITANIO/TITANIUM	270414
MOKA MOCHA	270405	BRONZO RIACI/RIACI BRONZE	270415
CROMO/CHROME	270408	VERDE COSTA/GREEN COAST	270416

N.B. Il codice contiene n° 2 testate di chiusura / The code contains 2 closing dead ends

CABLAGGIO DRIVER CE
DRIVER CE WIRING

	CODICE CODE
MONTAGGIO CABLAGGIO COLLAUDO CE DRIVER 60W / MOUNTING WIRING TESTING CE MARKING DRIVER 60W	1050A
MONTAGGIO CABLAGGIO COLLAUDO CE DRIVER 96W / MOUNTING WIRING TESTING CE MARKING DRIVER 96W	1096A
MONTAGGIO CABLAGGIO COLLAUDO CE DRIVER DIM 70W / MOUNTING WIRING TESTING CE MARKING DIM DRIVER 70W	1070D
MONTAGGIO CABLAGGIO COLLAUDO CE DRIVER DIM 100W / MOUNTING WIRING TESTING CE MARKING DRIVER DIM 100W	1101D
MONTAGGIO CABLAGGIO COLLAUDO CE DRIVER DIM 120W / MOUNTING WIRING TESTING CE MARKING DRIVER DIM 120W	1120D



float l

scheda tecnica



DRIVER 24V NON INCLUSO / NOT INCLUDED

LUNGHEZZA CAVO ALIMENTAZIONE: 50 cm
ALIMENTATION CABLE LENGTH: 50 cm

N.B. NON È POSSIBILE ORDINARE IL PRODOTTO SENZA ALIMENTATORE
N.B. IT IS NOT POSSIBLE TO ORDER THE PRODUCT WITHOUT THE POWER SUPPLY

DATI TECNICI
TECHNICAL DATA

	1 cm - 35W/m	1 cm - 15W/m + RGB
Nominal LED Flux:	↑ 2100 lm/m - 1224 lm/m ↓	↑ RGB - 1224 lm/m ↓
Flux Tot:	↑ 1680 lm/m - 980 lm/m ↓	↑ RGB - 980 lm/m ↓
Output:	↑ 105 lm/m - 85 lm/m ↓	↑ RGB - 85 lm/m ↓
CCT:	3000 K	3000 K
CRI:	>90	>90
Power:	↑ 20.0W/m - 15.0W/m ↓	↑ RGB15W/m - 15.0W/m ↓
Power Tot:	35.0W/m	30.0W/m
Weight:	1.50 Kg/m	1.50 Kg/m
Profilo/Profile:	Alluminio/aluminum	Cover: Opale/opal

FINITURA STRUTTURA
FINISHES

GRIGIO VESUVIO ANTHRACITE
ARGILLA CLAY
BIANCO INTONACO/WHITE
NERO CARAVAGGIO BLACK
MOKA MOCHA
CROMO/CHROME
ORO CALIFORNIA/GOLD
ARAMEN COPPER
ARGENTO COMETA/SILVER COMET
TITANIO/TITANIUM
BRONZO RIACI/RIACI BRONZE
VERDE COSTA/GREEN COAST

DIFFUSORE
DIFFUSER

OPALE/OPAL

1 cm - 35W/m

CODICE CODE
2714L00001
2714L01001
2714L03001
2714L04001
2714L05001
2714L08001
2714L09001
2714L10001
2714L12001
2714L14001
2714L15001
2714L16001

1 cm - 15W/m + RGB 15W/m

CODICE CODE
2799L00001
2799L01001
2799L03001
2799L04001
2799L05001
2799L08001
2799L09001
2799L10001
2799L12001
2799L14001
2799L15001
2799L16001

TESTATE DI CHIUSURA / DEAD ENDS

FINITURA STRUTTURA FINISHES	CODICE CODE	FINITURA STRUTTURA FINISHES	CODICE CODE
GRIGIO VESUVIO ANTHRACITE	270400	ORO CALIFORNIA/GOLD	270409
ARGILLA CLAY	270401	ARAMEN COPPER	270410
BIANCO INTONACO/WHITE	270403	ARGENTO COMETA/SILVER COMET	270412
NERO CARAVAGGIO BLACK	270404	TITANIO/TITANIUM	270414
MOKA MOCHA	270405	BRONZO RIACI/RIACI BRONZE	270415
CROMO/CHROME	270408	VERDE COSTA/GREEN COAST	270416

N.B. Il codice contiene n° 2 testate di chiusura / The code contains 2 closing dead ends

CABLAGGIO DRIVER CE
DRIVER CE WIRING

	CODICE CODE
MONTAGGIO CABLAGGIO COLLAUDO CE DRIVER 60W / MOUNTING WIRING TESTING CE MARKING DRIVER 60W	1050A
MONTAGGIO CABLAGGIO COLLAUDO CE DRIVER 96W / MOUNTING WIRING TESTING CE MARKING DRIVER 96W	1096A
MONTAGGIO CABLAGGIO COLLAUDO CE DRIVER DIM 70W / MOUNTING WIRING TESTING CE MARKING DIM DRIVER 70W	1070D
MONTAGGIO CABLAGGIO COLLAUDO CE DRIVER DIM 100W / MOUNTING WIRING TESTING CE MARKING DRIVER DIM 100W	1101D
MONTAGGIO CABLAGGIO COLLAUDO CE DRIVER DIM 120W / MOUNTING WIRING TESTING CE MARKING DRIVER DIM 120W	1120D



“versatilità e il comfort visivo”

Una lampada da parete che si può progettare e personalizzare. Eco è un semplice profilo con emissione indiretta e diretta/indiretta. L'utente può scegliere la LUNGHEZZA e regolare l'emissione indiretta tramite l'elemento laterale rotante (di 27gradi). Si ottiene un fascio indiretto più o meno aperto, ma si evitano anche fastidiosi abbagliamenti. Eco è un apparecchio che unisce la versatilità e il comfort visivo con una presenza grafica minimale.

Design and customize your wall lamp. Eco is a simple profile emitting indirect or direct/indirect light. The user can choose length and adjust the indirect emission just rotating (27 degrees) the metal strip. Obtaining the perfect indirect beam and protect himself from irritating dazzle. Eco is a versatile lighting concept with visual comfort and a minimal graphic impact.





DRIVER 24V NON INCLUSO / NOT INCLUDED

LUNGHEZZA CAVO ALIMENTAZIONE: 50 cm
ALIMENTATION CABLE LENGTH: 50 cm

DATI TECNICI
TECHNICAL DATA

	1 cm - 48W/m	1 cm - 60W/m
Nominal LED Flux:	↑ 2975 lm/m - 2975 lm/m ↓	↑ 3150 lm/m - 3150 lm/m ↓
Flux Tot:	↑ 2380 lm/m - 2380 lm/m ↓	↑ 2520 lm/m - 2520 lm/m ↓
Output:	125 lm/W	105 lm/W
CCT:	3000 K	3000 K
CRI:	>95	>90
Power:	↑ 24.0W/m - 24.0W/m ↓	↑ 30.0W/m - 30.0W/m ↓
Power Tot:	48.0W/m	60.0W/m
Weight:	1.40 Kg/m	1.40 Kg/m

Profilo/Profile: Alluminio/aluminum

Cover: Trasparente/trasparent

FINITURA STRUTTURA
FINISHES

- GRIGIO VESUVIO ANTHRACITE
- ARGILLA CLAY
- BIANCO INTONACO/WHITE
- NERO CARAVAGGIO BLACK
- MOKA MOCHA
- CROMO/CHROME
- ORO CALIFORNIA/GOLD
- GRIGIO AVIO GREY AVIO
- ARGENTO COMETA/SILVER COMET
- OTTONE VENEZIANO/VENETIAN BRASS
- TITANIO/TITANIUM
- BRONZO RIACI/RIACI BRONZE
- VERDE COSTA/GREEN COAST
- TERRA SENESE SENESE EARTH

DIFFUSORE
DIFFUSER

- TRASPARENTE/TRASPARENT
- TRASPARENTE/TRASPARENT

1 cm - 48W/m

CODICE CODE
115H700001
115H701001
115H703001
115H704001
115H705001
115H708001
115H709001
115H711001
115H712001
115H713001
115H714001
115H715001
115H716001
115H717001

1 cm - 60W/m

CODICE CODE
1158100001
1158101001
1158103001
1158104001
1158105001
1158108001
1158109001
1158111001
1158112001
1158113001
1158114001
1158115001
1158116001
1158117001

TESTATE DI CHIUSURA / DEAD ENDS

FINITURA STRUTTURA
FINISHES

- GRIGIO VESUVIO ANTHRACITE
- ARGILLA CLAY
- BIANCO INTONACO/WHITE
- NERO CARAVAGGIO BLACK
- MOKA MOCHA
- CROMO/CHROME
- ORO CALIFORNIA/GOLD

CODICE
CODE

- 1150400000
- 1150401000
- 1150403000
- 1150404000
- 1150405000
- 1150408000
- 1150409000

FINITURA STRUTTURA
FINISHES

- GRIGIO AVIO/GREY AVIO
- ARGENTO COMETA/SILVER COMET
- OTTONE VENEZIANO/VENETIAN BRASS
- TITANIO/TITANIUM
- BRONZO RIACI/RIACI BRONZE
- VERDE COSTA/GREEN COAST
- TERRA SENESE SENESE EARTH

CODICE
CODE

- 1150411000
- 1150412000
- 1150413000
- 1150414000
- 1150415000
- 1150416000
- 1150417000

N.B. Il codice contiene n° 2 testate di chiusura / The code contains 2 closing dead ends



DATI TECNICI
TECHNICAL DATA

	50 cm	100 cm	200 cm
Nominal LED Flux:	↑ 1487 lm - 1487 lm ↓	↑ 2975 lm/m - 2975 lm/m ↓	↑ 5950 lm - 5950 lm ↓
Flux Tot:	↑ 1190 lm - 1190 lm ↓	↑ 2380 lm/m - 2380 lm/m ↓	↑ 4760 lm - 4760 lm ↓
Output:	125 lm/W	125 lm/W	125 lm/W
CCT:	3000 K	3000 K	3000 K
CRI:	>95	>95	>95
Power:	↑ 12.0W - 12.0W ↓	↑ 24.0W/m - 24.0W/m ↓	↑ 48.0W - 48.0W ↓
Power Tot:	24.0W	48.0W/m	96.0W
Weight:	0.70 Kg	1.40 Kg/m	2.10 Kg

Profilo/Profile: Alluminio/aluminum

Cover: Trasparente/trasparent

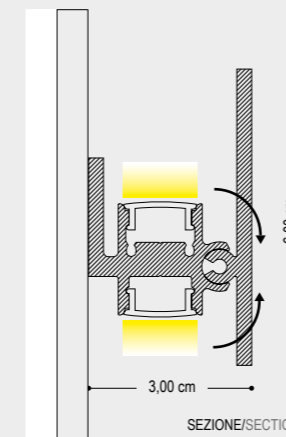

ARTICOLI INCLUSI NEL CODICE / ITEMS INCLUDED IN THE CODE:
DRIVER DIMMERABILE DALI PUSH / DIMMABLE DRIVER INCLUDED
COPPIA DI TESTATE DI CHIUSURA / PAIR OF CLOSING HEADS

LUNGHEZZA CAVO ALIMENTAZIONE / ALIMENTATION CABLE LENGTH: 50 cm

FINITURA STRUTTURA
FINISHES

- GRIGIO VESUVIO ANTHRACITE
- ARGILLA CLAY
- BIANCO INTONACO/WHITE
- NERO CARAVAGGIO BLACK
- MOKA MOCHA
- CROMO/CHROME
- ORO CALIFORNIA/GOLD
- GRIGIO AVIO GREY AVIO
- ARGENTO COMETA/SILVER COMET
- OTTONE VENEZIANO/VENETIAN BRASS
- TITANIO/TITANIUM
- BRONZO RIACI/RIACI BRONZE
- VERDE COSTA/GREEN COAST
- TERRA SENESE SENESE EARTH

DIFFUSORE
DIFFUSER

- TRASPARENTE/TRASPARENT
- TRASPARENTE/TRASPARENT

50 cm

CODICE CODE
115H700050
115H701050
115H703050
115H704050
115H705050
115H708050
115H709050
115H711050
115H712050
115H713050
115H714050
115H715050
115H716050
115H717050

100 cm

CODICE CODE
115H700100
115H701100
115H703100
115H704100
115H705100
115H708100
115H709100
115H711100
115H712100
115H713100
115H714100
115H715100
115H716100
115H717100

200 cm

CODICE CODE
115H700200
115H701200
115H703200
115H704200
115H705200
115H708200
115H709200
115H711200
115H712200
115H713200
115H714200
115H715200
115H716200
115H717200



“infinite esigenze progettuali”

Oggi sempre di più l'uomo tende a creare ambienti confortevoli in grado di stimolare positivamente i sensi delle persone. La luce in tutto questo gioca un ruolo da protagonista. INFINITO è stato pensato per rispondere positivamente a infinite esigenze progettuali, si avvale della tecnologia dell'estrusione di alluminio e policarbonato essenziali per dissipare e diffondere in maniera uniforme la luce per mezzo di led.

Humanity more and more attaches importance to create comfortable environments, that stimulate positively people's senses. The light, in this case, has the leading roll. INFINITO is the answer for endless projectable requirements. It makes use of the newest technologies of extruded aluminium and polycarbonate, which is essential for dispersing warmth and spreading light which is made by LEDs.



infinito

scheda tecnica



DRIVER NON INCLUSO / NOT INCLUDED

SI CONIGLIA DI UTILIZZARE I NOSTRI DRIVER WE RECOMMEND TO USE OUR DRIVERS

LUNGHEZZA CAVO ALIMENTAZIONE: 50 cm ALIMENTATION CABLE LENGTH: 50 cm

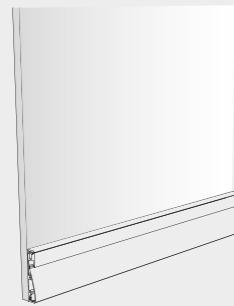

INSTALLAZIONE A PARETE WALL INSTALLATION



INSTALLAZIONE A INCASSO RECESSED INSTALLATION

DATI TECNICI TECHNICAL DATA

	1 cm
Nominal LED Flux:	1008 lm/m
Flux Tot:	807 lm/m
Output:	105 lm/W
CCT:	3000 K
CRI:	>90
Power Tot:	10.0W/m
Weight:	0.30 Kg/m

Profilo/Profile: Alluminio/aluminum Cover: Satinata/satin

1 cm

FINITURA STRUTTURA FINISHES

- ARGILLA CLAY
- BIANCO INTONACO/WHITE
- NERO CARAVAGGIO BLACK
- MOKA MOCHA
- TITANIO/TITANIUM
- BRONZO RIACI/RIACI BRONZE

DIFFUSORE DIFFUSER

SATINATA/SATIN

CODICE CODE

- 1131001001
- 1131003001
- 1131004001
- 1131005001
- 1131014001
- 1131015001



N.B. Durante l'installazione prestare attenzione affinché la staffa non subisca torsione. L'installazione con driver diversi da quelli da noi forniti esclude la garanzia.

N.B. During installation, take care to ensure that the bracket does not twist. Installation with drivers other than those supplied by us excludes the warranty.

STAFFA DI FISSAGGIO A PARETE / WALL MOUNTING CLIP

DATI TECNICI TECHNICAL DATA

MATERIALE: Alluminio naturale MATERIAL: Natural aluminum

N.B. Durante l'installazione prestare attenzione affinché la staffa non subisca torsione. N.B. During the installation, pay attention so that the bracket is not twisted.



1 cm



FINITURA STRUTTURA FINISHES

- ARGILLA CLAY
- BIANCO INTONACO/WHITE
- NERO CARAVAGGIO BLACK
- MOKA MOCHA
- TITANIO/TITANIUM
- BRONZO RIACI/RIACI BRONZE

CODICE CODE

- 1130501001
- 1130503001
- 1130504001
- 1130505001
- 1130514001
- 1130515001

STAFFA DI FISSAGGIO A CARTONGESSO / PLASTERBOARD MOUNTING CLIP

DATI TECNICI TECHNICAL DATA

MATERIALE: Alluminio naturale MATERIAL: Natural aluminum

N.B. Durante l'installazione prestare attenzione affinché la staffa non subisca torsione. N.B. During the installation, pay attention so that the bracket is not twisted.



1 cm



FINITURA STRUTTURA FINISHES

ALLUMINIO NATURALE/ALUMINUM

CODICE CODE

1130500001



infinito

scheda tecnica

TESTATE DI CHIUSURA / DEAD ENDS

DATI TECNICI TECHNICAL DATA

MATERIALE: Alluminio naturale MATERIAL: Natural aluminum

FINITURA STRUTTURA FINISHES

- ARGILLA CLAY
- BIANCO INTONACO/WHITE
- NERO CARAVAGGIO BLACK
- MOKA MOCHA
- TITANIO/TITANIUM
- BRONZO RIACI/RIACI BRONZE

CODICE CODE

- 1130401000
- 1130403000
- 1130404000
- 1130405000
- 1130414000
- 1130415000



Nel codice sono comprese le viti per il fissaggio delle testate al profilo. Il codice contiene n° 1 testate di chiusura. The code includes the screws for fixing the heads to the profile. The code contains 1 closing warheads

LAVORAZIONI / PROCESSING

DATI TECNICI TECHNICAL DATA



TAGLIO 90° ORIZZONTALE (PER ANGOLI FORMATI DA DUE PROFILI) HORIZONTAL 90 ° CUT (FOR CORNERS MADE OF TWO PROFILES)

ASOLA / SLOT

ASOLA CUSTOM / SLOT CUSTOM

FORO / HOLE

CODICE CODE

- 190X
- 100A
- 100 N
- 100F

infinito

installazione a parete

wall installation

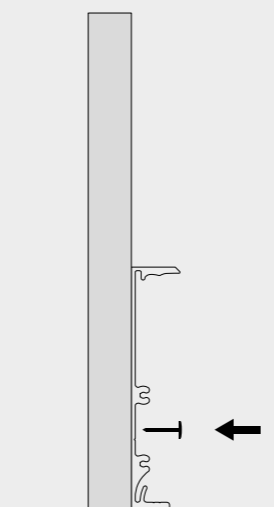

1. FORARE LA STAFFA IN ALLUMINIO PER CONSENTIRNE IL FISSAGGIO PER MEZZO DI TASSELLI IDONEI AL SUPPORTO MURARIO. PRESTARE ATTENZIONE AFFICHÈ LA STAFFA NON SUBISCA TORSIONE.

1. DRILL THE ALUMINUM BRACKET TO ALLOW IT TO BE FIXED BY MEANS OF SUITABLE DOWELS TO THE WALL SUPPORT. PAY ATTENTION SO THAT THE BRACKET DOES NOT BE TORSIONED.

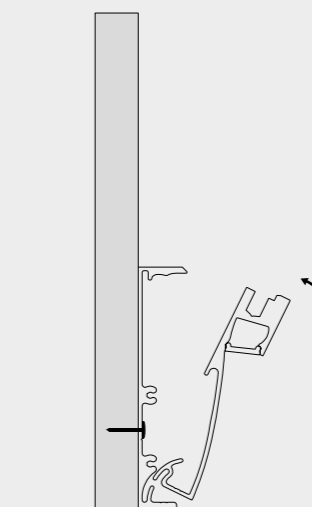

2. ATTENZIONE! PRIMA DI EFFETTUARE I COLLEGAMENTI ELETTRICI ASSICURARSI CHE L'ALIMENTAZIONE PRINCIPALE SIA STATA STACCATA. IL PRODOTTO INFINITO FUNZIONA CORRETTAMENTE SE VIENE ALIMENTATO A 24V E CON POTENZA PROPORZIONATA. LA DESIGN LUCE NON SI ASSUME QUALSIVOGLIA RESPONSABILITÀ PER UN'INSTALLAZIONE NON CORRETTA DEL PRODOTTO.

2. ATTENTION! BEFORE MAKING THE ELECTRICAL CONNECTIONS MAKE SURE THAT THE MAIN POWER SUPPLY HAS BEEN DISCONNECTED. THE INFINITO PRODUCT WORKS CORRECTLY IF IT IS POWERED AT 24V AND WITH PROPORTIONAL POWER. DESIGN LUCE DOES NOT ASSUME ANY LIABILITY FOR AN INCORRECT INSTALLATION OF THE PRODUCT.

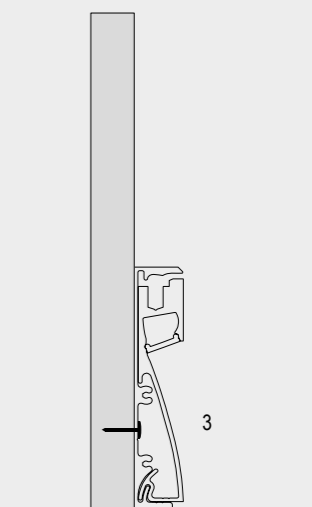

3. INSERIRE IL PROFILO NELL'APPOSITO ALLOGGIO

3. INSERT THE PROFILE IN THE ACCOMMODATION



“ linee d’ombra e di luce austere e rigorose ”

Coniugando nella sua forma estetica e funzionalità, il corrimano in pietra tipico degli antichi palazzi fiorentini, riesce con la materia ad esaltare la percezione tattile e la sofisticata artigianalità della sua lavorazione. La sezione cilindrica ne favorisce la presa, curve e modanature creano quelle lunghe linee d’ombra e di luce “austere e rigorose”, di comfort nella salita, di sostegno nella discesa. MANCORRENTE si ispira direttamente a questa tradizione e sfruttando la tecnica dell’estrusione ne reinterpreta la forma. Con la sua contemporanea artigianalità industriale e la sua rinnovata modularità sartoriale, il nuovo corrimano ci consente di personalizzare rampe e scale in ambito pubblico e privato.

Combining in its aesthetic form and functionality, the stone handrail typical of the ancient Florentine palaces manages to enhance the tactile perception and the sophisticated craftsmanship of its workmanship with the material. The cylindrical section favors its grip, curves and moldings create those long lines of shadow and light “austere and rigorous”, comfort in the ascent, support in the descent. MANCORRENTE is directly inspired by this tradition and exploiting the extrusion technique reinterprets its shape. With its contemporary industrial craftsmanship and its renewed sartorial modularity, the new handrail allows us to customize ramps and stairs in the public and private sphere.



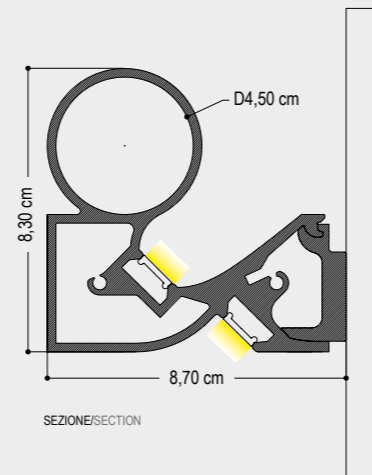
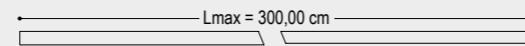

CABLAGGIO DRIVER CE
DRIVER CE WIRING

MONTAGGIO CABLAGGIO COLLAUDO CE DRIVER 60W / MOUNTING WIRING TESTING CE MARKING DRIVER 60W	1050A
MONTAGGIO CABLAGGIO COLLAUDO CE DRIVER 96W / MOUNTING WIRING TESTING CE MARKING DRIVER 96W	1096A
MONTAGGIO CABLAGGIO COLLAUDO CE DRIVER DIM 70W / MOUNTING WIRING TESTING CE MARKING DIM DRIVER 70W	1070D
MONTAGGIO CABLAGGIO COLLAUDO CE DRIVER DIM 100W / MOUNTING WIRING TESTING CE MARKING DRIVER DIM 100W	1101D
MONTAGGIO CABLAGGIO COLLAUDO CE DRIVER DIM 120W / MOUNTING WIRING TESTING CE MARKING DRIVER DIM 120W	1120D

CODICE
CODE



DRIVER 24V NON INCLUSO / NOT INCLUDED

LUNGHEZZA CAVO ALIMENTAZIONE: 50 cm
ALIMENTATION CABLE LENGTH: 50 cm

IN CASO DI INSTALLAZIONE PER MEZZO DI DRIVER REMOTI SI CONSIGLIA DI USARE I NOSTRI DRIVER PRESENTI NEL CATALOGO A CAPITOLO ULTIMO "DRIVER"
IN CASE OF INSTALLATION USING A DRIVER REMOTE WE RECOMMEND USING OUR DRIVERS PRESENT IN THE CATALOG IN LAST CHAPTER "DRIVER"

ARTICOLI INCLUSI NEL CODICE:
PROFILO MANCORRENTE CON LED INTEGRATO;
STAFFA IN ALLUMINIO PER FISSAGGIO A PARETE.

ITEMS INCLUDED IN THE CODE:
MISSING PROFILE WITH INTEGRATED LED;
ALUMINUM BRACKET FOR WALL FIXING.

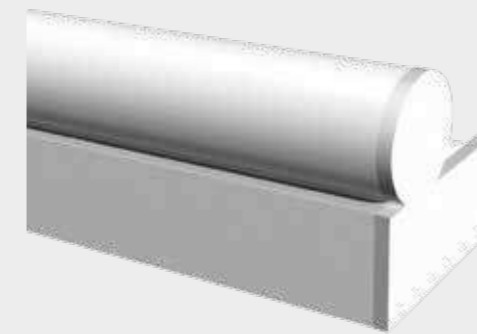

FINITURA STRUTTURA
FINISHES

- GRIGIO VESUVIO ANTHRACITE
- BIANCO INTONACO/WHITE
- NERO CARAVAGGIO BLACK
- MOKA MOCHA
- ARGENTO COMETA/SILVER COMET
- TITANIO/TITANIUM**
- BRONZO RIACI/RIACI BRONZE
- TERRA SENESE SENESE EARTH

DIFFUSORE
DIFFUSER

SATINATA/SATIN

1 cm

CODICE
CODE

- 1232000001
- 1232003001
- 1232004001
- 1232005001
- 1232012001
- 1232014001
- 1232015001
- 1232017001

Profilo/Profile: Alluminio/aluminum Cover: Satinata/satin

N.B. Durante l'installazione prestare attenzione affinché la staffa non subisca torsione. L'installazione con driver diversi da quelli da noi forniti esclude la garanzia
N.B. During installation, take care to ensure that the bracket does not twist. Installation with drivers other than those supplied by us excludes the warranty

TESTATE DI CHIUSURA / DEAD ENDS

DATI TECNICI
TECHNICAL DATA

MATERIALE: Alluminio naturale
MATERIAL: Natural aluminum



FINITURA STRUTTURA
FINISHES

- GRIGIO VESUVIO ANTHRACITE
- BIANCO INTONACO/WHITE
- NERO CARAVAGGIO BLACK
- MOKA MOCHA
- ARGENTO COMETA/SILVER COMET
- TITANIO/TITANIUM**
- BRONZO RIACI/RIACI BRONZE
- TERRA SENESE SENESE EARTH

CODICE
CODE

- 1230400000
- 1230403000
- 1230404000
- 1230405000
- 1230412000
- 1230414000
- 1230415000
- 1230417000

Nel codice sono comprese le viti per il fissaggio delle testate al profilo. Il codice contiene n° 2 testate di chiusura.
The code includes the screws for fixing the heads to the profile. The code contains 2 closing dead ends.

GIUNTO LINEA CONTINUA / STRAIGHT JOINT

DATI TECNICI
TECHNICAL DATA

MATERIALE: Alluminio naturale
MATERIAL: Natural aluminum



FINITURA STRUTTURA
FINISHES

ALLUMINIO NATURALE/ALUMINUM

CODICE
CODE

1230506



“nuovo strumento di architettura e luce”

TRYTEN è un nuovo strumento di architettura e luce: è il profilo versatile necessario ad ogni progetto di architettura.

Ha una forma semplice a vela. A seconda del posizionamento scompare alla vista o rimane presente a costituire una cornice. Si possono ipotizzare almeno due utilizzi a parete, entrambi per illuminazione indiretta. TRY TEN si presta a utilizzi ben più numerosi assecondando le esigenze del progettista e il suo estro creativo. La sua struttura è in alluminio con diffusori in policarbonato.

TRYTEN is a new architectural and lighting item: a very versatile profile, necessary for every architectural project.

It has a simple sail-shape. Changing the positioning, it can disappear from the view or remain and create a sort of frame. It can be done at least two wall uses, both for indirect lighting. TRY TEN is suitable for many more uses, satisfying the needs of the designer and his creative flair. Its structure is in aluminum with polycarbonate diffusers.



tryten

configurazioni

configurations

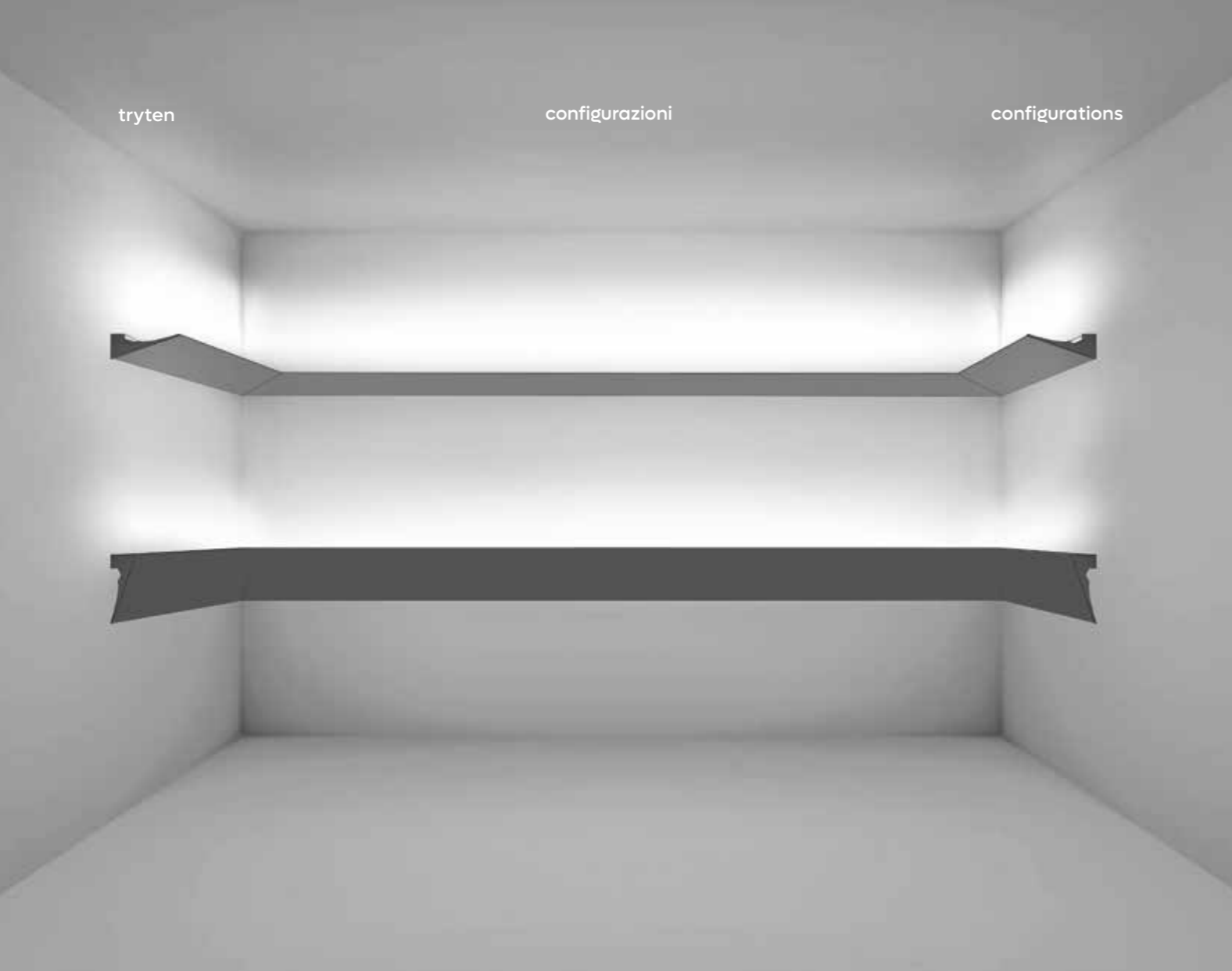

tryten

scheda tecnica

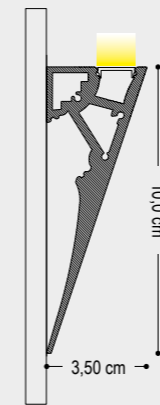

DRIVER 24V NON INCLUSO / NOT INCLUDED - L'installazione con driver diversi da quelli da noi forniti esclude la garanzia / Installation with drivers other than those supplied by us excludes the warranty

DATI TECNICI
TECHNICAL DATA

	24W		30W
Nominal LED Flux:	2975 lm/m		3150 lm/m
Flux Tot:	2380 lm/m		2150 lm/m
Output:	125 lm/W	F	105 lm/W
CCT:	3000 K		3000 K
CRI:	>95		>90
Power Tot:	24.0W/m		30.0W/m
Weight:	1.90 Kg		1.90 Kg

Profilo/Profile: Alluminio/aluminum

Cover: Satinata/satin

FINITURA STRUTTURA
FINISHES

- GRIGIO VESUVIO ANTHRACITE
- ARGILLA CLAY
- BIANCO INTONACO/WHITE
- NERO CARAVAGGIO BLACK
- MOKA MOCHA
- CROMO CHROME
- ORO CALIFORNIA GOLD
- ARAMEN COPPER
- GRIGIO AVIO GREY AVIO
- ARGENTO COMETA/SILVER COMET
- OTTONE VENEZIANO BRASS
- TERRA SENESE SENESE EARTH

DIFFUSORE
DIFFUSER

SATINATA/SATIN

24W/m

30W/m

CODICE
CODE

CODICE
CODE

107H700011	1078100011
107H701011	1078101011
107H703011	1078103011
107H704011	1078104011
107H705011	1078105011
107H708011	1078108011
107H709011	1078109011
107H710011	1078110011
107H711011	1078111011
107H712011	1078112011
107H713011	1078113011
107H717011	1078117011

TESTATE DI CHIUSURA VERSIONE POINT / POINT DEAD ENDS VERSION

FINITURA STRUTTURA
FINISHES

- GRIGIO VESUVIO ANTHRACITE
- ARGILLA CLAY
- BIANCO INTONACO/WHITE
- NERO CARAVAGGIO BLACK
- MOKA MOCHA
- CROMO CHROME

CODICE
CODE

- 1070500000
- 1070501000
- 1070503000
- 1070504000
- 1070505000
- 1070508000

FINITURA STRUTTURA
FINISHES

- ORO CALIFORNIA GOLD
- ARAMEN COPPER
- GRIGIO AVIO GREY AVIO
- ARGENTO COMETA/SILVER COMET
- OTTONE VENEZIANO VENETIAN BRASS
- TERRA SENESE SENESE EARTH

CODICE
CODE

- 1070509000
- 1070510000
- 1070511000
- 1070512000
- 1070513000
- 1070517000

N.B. Il codice contiene n° 2 testate di chiusura / The code contains 2 closing dead ends

LAVORAZIONI / PROCESSING

DATI TECNICI
TECHNICAL DATA



TAGLIO 90° ORIZZONTALE (PER ANGOLI FORMATI DA DUE PROFILI)
HORIZONTAL 90 ° CUT (FOR CORNERS MADE OF TWO PROFILES)

CODICE
CODE

- 190X
- 100A
- 100F



ASOLA / SLOT



FORO / HOLE

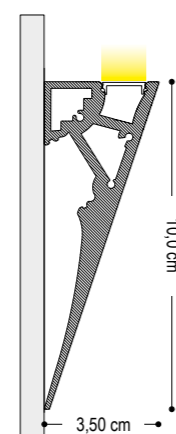

TRY TEN
Point

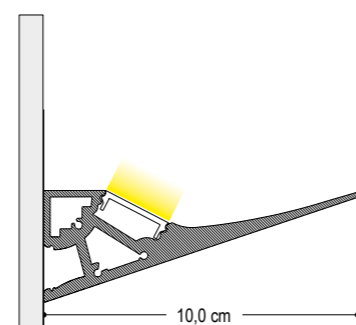

TRY TEN
WALL WASHER

Lmax = 300,00 cm

tryten

scheda tecnica

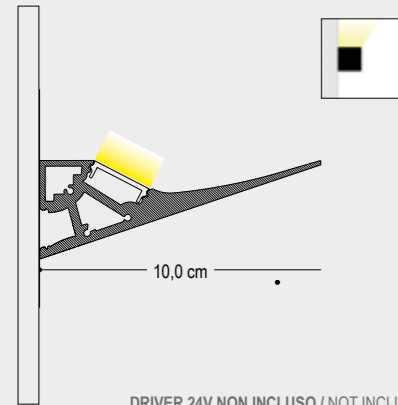

DATI TECNICI TECHNICAL DATA			
	24W		30W
Nominal LED Flux:	2975 lm/m		3150 lm/m
Flux Tot:	2380 lm/m		2150 lm/m
Output:	125 lm/W	F	105 lm/W
CCT:	3000 K		3000 K
CRI:	>95		>90
Power Tot:	24.0W/m		30.0W/m
Weight:	1.90 Kg		1.90 Kg
Profilo/Profile:	Alluminio/aluminum		Cover: Satinata/satin

DRIVER 24V NON INCLUSO / NOT INCLUDED -
L'installazione con driver diversi da quelli da noi forniti esclude la garanzia / Installation with drivers other than those supplied by us excludes the warranty

FINITURA STRUTTURA FINISHES	DIFFUSORE DIFFUSER	24W/m	30W/m
		CODICE CODE	CODICE CODE
GRIGIO VESUVIO ANTHRACITE	SATINATA/SATIN	107H700001	1078100001
ARGILLA CLAY		107H701001	1078101001
BIANCO INTONACO/WHITE		107H703001	1078103001
NERO CARAVAGGIO BLACK		107H704001	1078104001
MOKA MOCHA		107H705001	1078105001
CROMO CHROME		107H708001	1078108001
ORO CALIFORNIA/GOLD		107H709001	1078109001
ARAMEN COPPER		107H710001	1078110001
GRIGIO AVIO GREY AVIO		107H711001	1078111001
ARGENTO COMETA/SILVER COMET		107H712001	1078112001
OTTONE VENEZIANO BRASS		107H713001	1078113001
TERRA SENESE SENESE EARTH		107H717001	1078117001

tryten 25/50/100

scheda tecnica

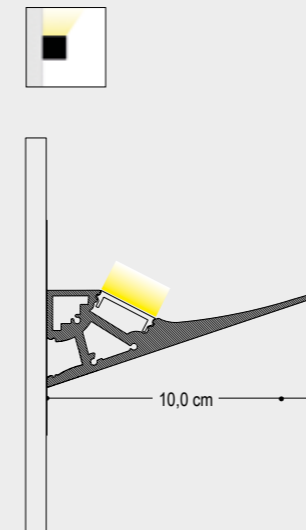

DATI TECNICI TECHNICAL DATA			
	25 cm	50 cm	100 cm
Nominal LED Flux:	744 lm	1487 lm	2975 lm
Flux Tot:	595 lm	1190 lm	2380 lm
Output:	125 lm/W	125 lm/W	125 lm/W
CCT:	3000 K	3000 K	3000 K
CRI:	>95	>95	>95
Power Tot:	6.0W	12.0W	24.0W
Weight:	0.50 Kg	0.80 Kg	1.90 Kg
Profilo/Profile:	Alluminio/aluminum		Cover: Satinata/satin

LUNGHEZZA CAVO ALIMENTAZIONE: 50 cm
ALIMENTATION CABLE LENGTH: 50 cm

ARTICOLI INCLUSI NEL CODICE:
ITEMS INCLUDED IN THE CODE:
DRIVER ON/OFF / DRIVER ON/OFF INCLUDED
COPPIA DI TESTATE DI CHIUSURA / PAIR OF CLOSING HEADS

FINITURA STRUTTURA FINISHES	DIFFUSORE DIFFUSER	25 cm	50 cm	100 cm
		CODICE CODE	CODICE CODE	CODICE CODE
GRIGIO VESUVIO ANTHRACITE	SATINATA/SATIN	107H700025	107H700050	107H700100
ARGILLA CLAY		107H701025	107H701050	107H701100
BIANCO INTONACO/WHITE		107H703025	107H703050	107H703100
NERO CARAVAGGIO BLACK		107H704025	107H704050	107H704100
MOKA MOCHA		107H705025	107H705050	107H705100
CROMO CHROME		107H708025	107H708050	107H708100
ORO CALIFORNIA/GOLD		107H709025	107H709050	107H709100
ARAMEN COPPER		107H710025	107H710050	107H710100
GRIGIO AVIO GREY AVIO		107H711025	107H711050	107H711100
ARGENTO COMETA/SILVER COMET		107H712025	107H712050	107H712100
OTTONE VENEZIANO BRASS		107H713025	107H713050	107H713100
TERRA SENESE SENESE EARTH		107H717025	107H717050	107H717100

TESTATE DI CHIUSURA VERSIONE WALL WASHER / WALL WASHER DEAD ENDS VERSION

FINITURA STRUTTURA FINISHES	CODICE CODE	FINITURA STRUTTURA FINISHES	CODICE CODE
GRIGIO VESUVIO ANTHRACITE	1070400000	ORO CALIFORNIA/GOLD	1070409000
ARGILLA CLAY	1070401000	ARAMEN COPPER	1070410000
BIANCO INTONACO/WHITE	1070403000	GRIGIO AVIO GREY AVIO	1070411000
NERO CARAVAGGIO BLACK	1070404000	ARGENTO COMETA/SILVER COMET	1070412000
MOKA MOCHA	1070405000	OTTONE VENEZIANO VENETIAN BRASS	1070413000
CROMO CHROME	1070408000	TERRA SENESE SENESE EARTH	1070417000

N.B. Il codice contiene n° 2 testate di chiusura / The code contains 2 closing dead ends

LAVORAZIONI / PROCESSING

DATI TECNICI TECHNICAL DATA	CODICE CODE
TAGLIO 90° ORIZZONTALE (PER ANGOLI FORMATI DA DUE PROFILI) HORIZONTAL 90° CUT (FOR CORNERS MADE OF TWO PROFILES)	190X
ASOLA / SLOT	100A
ASOLA CUSTOM / SLOT CUSTOM	100N
FORO / HOLE	100F

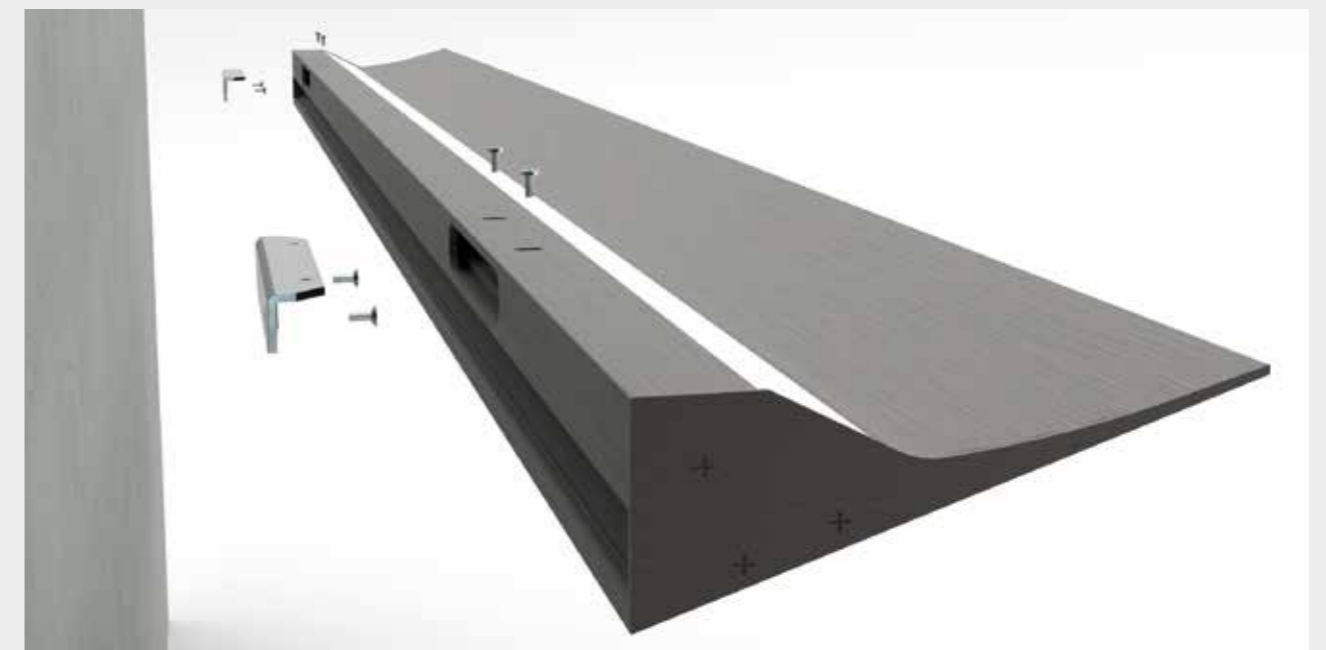

soffitto parete

designluce

wall ceiling

indice

olimpia [308](#)

altis [312](#)

orbita [316](#)

davinci [320](#)

micelangelo [324](#)

link [328](#)

link point + advanced [332](#)

t24 + m24 [338](#)

in + out [348](#)

kepler [354](#)

“nuove forme geometriche”

OLIMPIA inaugura la nuova sfida di Design Luce: illuminare gli spazi architettonici con nuove forme geometriche. Per questa lampada abbiamo pensato al cerchio, da sempre forma elementare ed armonica. OLIMPIA racchiude in se tutta l'eleganza e la leggerezza di una lampada LED dagli elevati contenuti tecnici ed illuminotecnici. Grazie allo studio del posizionamento dei gruppi ottici, che garantiscono la doppia emissione, alla regolazione luminosa, oltre ai diametri e finiture customizzabili.

OLIMPIA inaugurates the new challenge of Design Luce: lighting architectural spaces with new geometric shapes. For this lamp we have thought about the circle, elementary and harmonic. OLIMPIA embodies all the elegance and lightness of a LED lamp with high technical and engineering contents as the positioning of the optical groups, which guarantee a double emission, the luminous regulation and the customizable diameter and finishes.





Dmin = 45,00 cm / Dmax = 180,00 cm

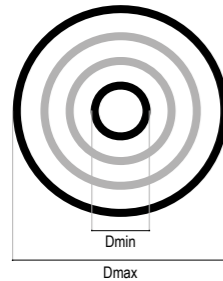

Il prodotto verrà fornito come unica circonferenza
The product will be supplied as a single circumference

D > 180,00 cm

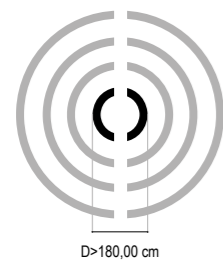

Il prodotto verrà fornito in più archi di circonferenza da giuntare
The product will be supplied in several circumference arcs to be joined

Per il dimensionamento della sezione del cavo di alimentazione contattare il Nostro reparto tecnico.
For the sizing of the power cable section, contact our technical department.

Gli schemi riportati nelle presenti schede sono puramente indicativi. Ogni richiesta di customizzazione va sottoposta esclusivamente alla Design Luce srl che ne valuterà la fattibilità tecnica.
The diagrams shown in these sheets are purely indicative. Any request for customization must be submitted exclusively to the Design Luce srl which will evaluate its technical feasibility.

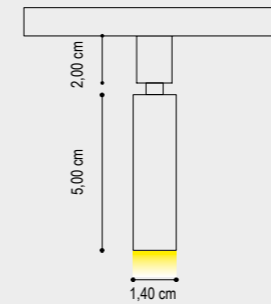

SEZIONE PROFILO/PROFILE SECTION

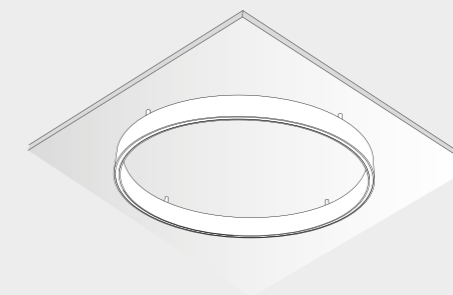

OLIMPIA CON DRIVER REMOTO
OLIMPIA WITH REMOTE DRIVER

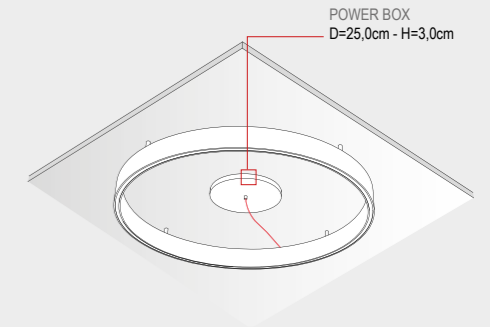

OLIMPIA CON BOX
OLIMPIA WITH POWER SUPPLY BOX



DRIVER 24V ON/OFF INCLUSO PER INSTALLAZIONE IN REMOTO
DRIVER 24V ON/OFF INCLUDED FOR REMOTE INSTALLATION
SUPPORTI FISSAGGIO SOFFITTO INCLUSI
CEILING MOUNTING SUPPORTS INCLUDED

CAVO ALIMENTAZIONE: 50 cm
ALIMENTATION CABLE: 50 cm

DATI TECNICI
TECHNICAL DATA

	D 45 cm	D 55 cm	D 75 cm
Nominal LED Flux:	5372 lm	6636 lm	9006 lm
Flux Tot:	4298 lm	5309 lm	7205 lm
Output:	158 lm/W	158 lm/W	158 lm/W
CCT:	3000 K	3000 K	3000 K
CRI:	>90	>90	>90
Power Tot:	34.0W	42.0W	57.0W
Weight:	1.42 Kg	1.90 Kg	2.50 Kg

Profilo/Profile: Alluminio/aluminum

Cover: Satinata/satin

FINITURA STRUTTURA
FINISHES

- BIANCO INTONACO/WHITE
- NERO CARAVAGGIO BLACK
- CROMO CHROME
- ORO CALIFORNIA/GOLD
- ARAMEN COPPER
- GRIGIO AVIO/GREY AVIO
- ARGENTO COMETA/SILVER COMET
- OTTONE VENEZIANO/VENETIAN BRASS

	D 45 cm	D 55 cm	D 75 cm
CODICE CODE	4055035045	4055035055	4055035075
CODICE CODE	4055045045	4055045055	4055045075
CODICE CODE	4055085045	4055085055	4055085075
CODICE CODE	4055095045	4055095055	4055095075
CODICE CODE	4055105045	4055105055	4055105075
CODICE CODE	4055115045	4055115055	4055115075
CODICE CODE	4055125045	4055125055	4055125075
CODICE CODE	4055135045	4055135055	4055135075

ATTENZIONE/PLEASE NOTE: SU RICHIESTA DIAMETRO CUSTOM / CUSTOM DIAMETER ON REQUEST

BOX DI ALIMENTAZIONE CON FORO CENTRALE / POWER SUPPLY BOX WITH CENTRAL HOLE

FINITURA STRUTTURA / FINISHES		BIANCO INTONACO/WHITE				
	60W	96W	120W (2x60W)	156W	192W (2x96W)	
TIPOLOGIA TYPE	CODICE CODE	CODICE CODE	CODICE CODE	CODICE CODE	CODICE CODE	
ON/OFF	F03060	F03096	F03120	F03156	F03192	
DALI	S03060	S03096	S03120	S03156	S03192	

N.B.: VERSIONE 120W E 192W CONFIGURATI PER DOPPIA ACCENSIONE / PLEASE NOTE: 120W AND 192W VERSION CONFIGURED FOR DOUBLE IGNITION



“eleganza e leggerezza”

ALTIS inaugura la nuova sfida di Design Luce: illuminare gli spazi architettonici con nuove forme geometriche. Per questa lampada abbiamo pensato al cerchio, da sempre forma elementare e armonica.

ALTIS racchiude in sé tutta l'eleganza e la leggerezza di una lampada LED dagli elevati contenuti tecnici ed illuminotecnici. Grazie allo studio del posizionamento dei gruppi ottici, alla regolazione luminosa oltre a diametri e finiture customizzabili.

ALTIS inaugurates the new challenge of Design Luce: lighting architectural spaces with new geometric shapes. For this lamp we have thought about the circle, elementary and harmonic. ALTIS embodies all the elegance and lightness of a LED lamp with high technical and engineering contents as the positioning of the optical groups, which guarantee a double emission, the luminous regulation and the customizable diameter and finishes.



altis

customizzazione

customization

Dmin = 45,00 cm / Dmax = 180,00 cm

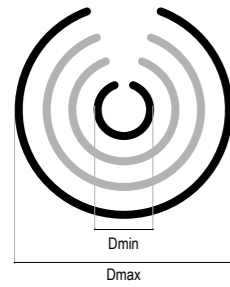

Il prodotto verrà fornito come unica circonferenza
The product will be supplied as a single circumference

D > 180,00 cm



Il prodotto verrà fornito in più archi di circonferenza da giuntare
The product will be supplied in several circumference arcs to be joined



Per il dimensionamento della sezione del cavo di alimentazione contattare il Nostro reparto tecnico.
For the sizing of the power cable section, contact our technical department.

Gli schemi riportati nelle presenti schede sono puramente indicativi. Ogni richiesta di customizzazione va sottoposta esclusivamente alla Design Luce srl che ne valuterà la fattibilità tecnica.
The diagrams shown in these sheets are purely indicative. Any request for customization must be submitted exclusively to the Design Luce srl which will evaluate its technical feasibility.

scheda tecnica

altis

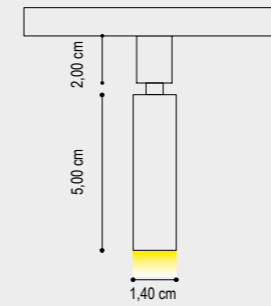

SEZIONE PROFILO/PROFILE SECTION

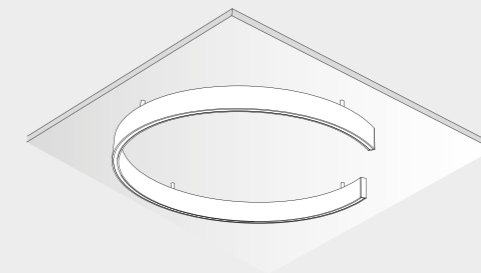

ALTIS CON DRIVER REMOTO
ALTIS WITH REMOTE DRIVER

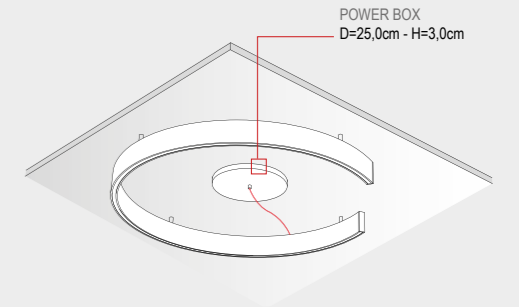

ALTIS CON BOX
ALTIS WITH POWER SUPPLY BOX



DATI TECNICI
TECHNICAL DATA

DRIVER 24V ON/OFF INCLUSO
PER INSTALLAZIONE IN REMOTO
DRIVER 24V ON/OFF INCLUDED
FOR REMOTE INSTALLATION

SUPPORTI FISSAGGIO SOFFITTO INCLUSI
CEILING MOUNTING SUPPORTS INCLUDED

CAVO ALIMENTAZIONE: 50 cm
ALIMENTATION CABLE: 50 cm

	D 45 cm	D 55 cm	D 75 cm
Nominal LED Flux:	4740 lm	6004 lm	8216 lm
Flux Tot:	3792 lm	4803 lm	6573 lm
Output:	158 lm/W	158 lm/W	158 lm/W
CCT:	3000 K	3000 K	3000 K
CRI:	>90	>90	>90
Power Tot:	30.0W	38.0W	52.0W
Weight:	1.42 Kg	1.90 Kg	2.50 Kg

Profilo/Profile: Alluminio/aluminum

Cover: Satinata/satin

FINITURA STRUTTURA
FINISHES

- BIANCO INTONACO/WHITE
- NERO CARAVAGGIO/BLACK
- CROMO/CHROME
- ORO CALIFORNIA/GOLD
- ARAMEN COPPER
- GRIGIO AVIO/GREY AVIO
- ARGENTO COMETA/SILVER COMET
- OTTONE VENEZIANO/VENETIAN BRASS

	D 45 cm	D 55 cm	D 75 cm
CODICE CODE	4155035045	4155035055	4155035075
CODICE CODE	4155045045	4155045055	4155045075
CODICE CODE	4155085045	4155085055	4155085075
CODICE CODE	4155095045	4155095055	4155095075
CODICE CODE	4155105045	4155105055	4155105075
CODICE CODE	4155115045	4155115055	4155115075
CODICE CODE	4155125045	4155125055	4155125075
CODICE CODE	4155135045	4155135055	4155135075

ATTENZIONE/PLEASE NOTE: SU RICHIESTA DIAMETRO CUSTOM / CUSTOM DIAMETER ON REQUEST

BOX DI ALIMENTAZIONE CON FORO CENTRALE /
POWER SUPPLY BOX WITH CENTRAL HOLE

FINITURA STRUTTURA / FINISHES		BIANCO INTONACO/WHITE				
	60W	96W	120W (2x60W)	156W	192W (2x96W)	
TIPOLOGIA TYPE	CODICE CODE	CODICE CODE	CODICE CODE	CODICE CODE	CODICE CODE	
ON/OFF	F03060	F03096	F03120	F03156	F03192	
DALI	S03060	S03096	S03120	S03156	S03192	

N.B.: VERSIONE 120W E 192W CONFIGURATI PER DOPPIA ACCENSIONE / PLEASE NOTE:
120W AND 192W VERSION CONFIGURED FOR DOUBLE IGNITION



“elisse come orbite”

ORBITA prosegue il progetto di Design Luce iniziato con OLIMPIA. L'ellisse è la naturale conseguenza del cerchio, una forma armonica che richiama le orbite che i corpi celesti descrivono intorno al Sole.

ORBITA racchiude in sé tutta l'eleganza e la leggerezza di una lampada LED dagli elevati contenuti tecnici ed illuminotecnici.

ORBITA continues the Design Luce project started with OLIMPIA. The ellipse is a new natural consequence of the circle, an harmonic form which recalls the orbit of celestial bodies. Around the sun. ORBITA embodies the elegance and lightness of a LED lamp with very high technical contents.

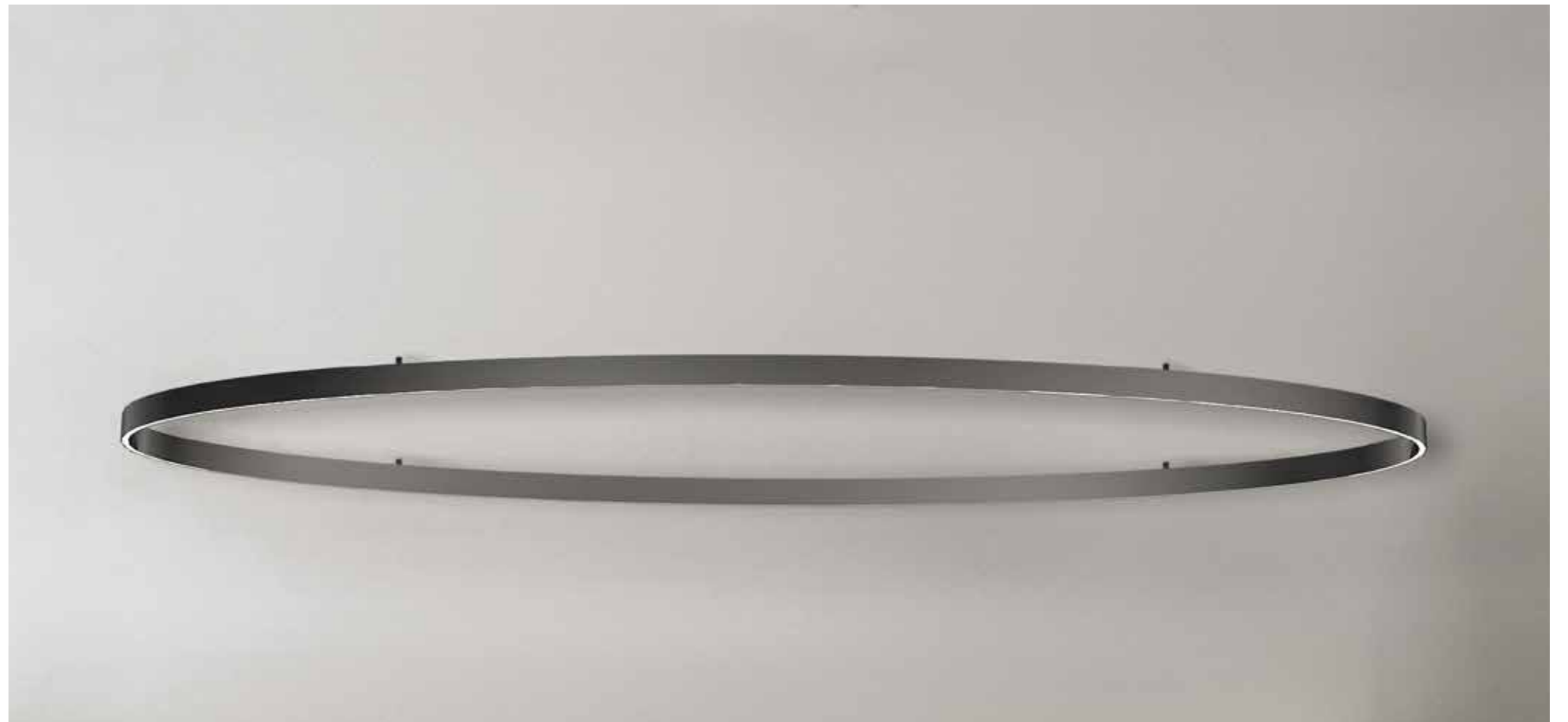

orbita

customizzazione

customization

Amin = 120,00 cm / Amax = 220,00 cm
Bmin = 60,00 cm / Bmax = 110,00 cm



Il prodotto verrà fornito come unica ellisse
The product will be supplied as a single ellipse

A > 220,00 cm
B > 110,00 cm

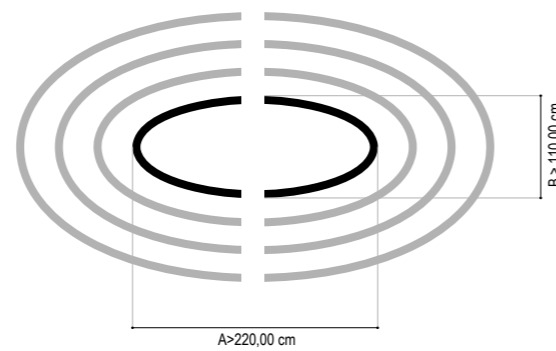

Il prodotto verrà fornito in più archi di ellisse da giuntare
The product will be supplied in several ellipse arcs to be joined



Per il dimensionamento della sezione del cavo di alimentazione contattare il Nostro reparto tecnico.
For the sizing of the power cable section, contact our technical department.

Gli schemi riportati nelle presenti schede sono puramente indicativi. Ogni richiesta di customizzazione va sottoposta esclusivamente alla Design Luce srl che ne valuterà la fattibilità tecnica.
The diagrams shown in these sheets are purely indicative. Any request for customization must be submitted exclusively to the Design Luce srl which will evaluate its technical feasibility.

scheda tecnica

orbita

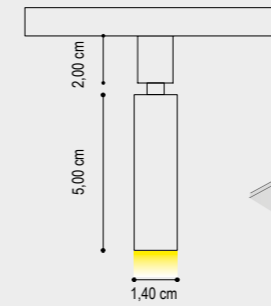

SEZIONE PROFILO/PROFILE SECTION

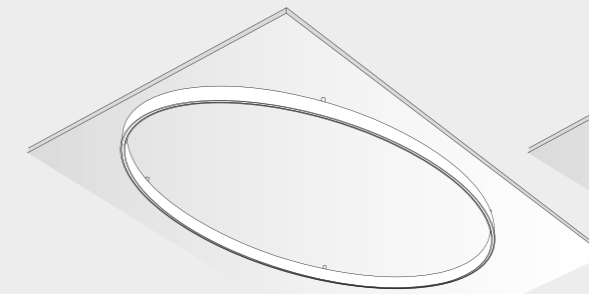

ORBITA CON DRIVER REMOTO
ORBITA WITH REMOTE DRIVER

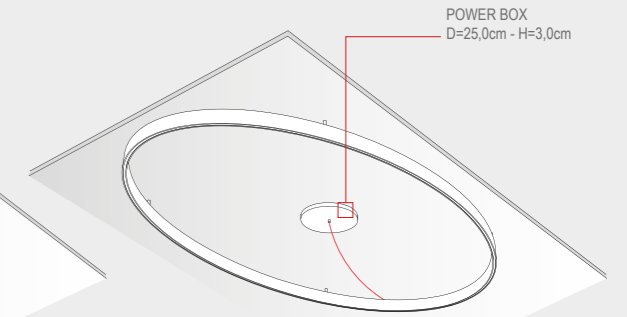

ORBITA CON BOX
ORBITA WITH POWER SUPPLY BOX



DRIVER 24V ON/OFF INCLUSO PER INSTALLAZIONE IN REMOTO
DRIVER 24V ON/OFF INCLUDED FOR REMOTE INSTALLATION

SUPPORTI FISSAGGIO SOFFITTO INCLUSI
CEILING MOUNTING SUPPORTS INCLUDED

CAVO ALIMENTAZIONE: 50 cm
ALIMENTATION CABLE: 50 cm

DATI TECNICI
TECHNICAL DATA

	COMPOSIZIONE C1		COMPOSIZIONE C2	
	120 cm / 60 cm	160 cm / 80 cm	160 cm / 80 cm	120 cm / 60 cm
Nominal LED Flux:	11218 lm	15010 lm	15010 lm	11218 lm
Flux Tot:	8974 lm	12008 lm	12008 lm	8974 lm
Output:	158 lm/W	158 lm/W	158 lm/W	158 lm/W
CCT:	3000 K	3000 K	3000 K	3000 K
CRI:	>90	>90	>90	>90
Power Tot:	71.0W	95.0W	95.0W	71.0W
Weight:	3.60 Kg	2.50 Kg	2.50 Kg	3.60 Kg

Profilo/Profile: Alluminio/aluminum

Cover: Satinata/satin

FINITURA STRUTTURA
FINISHES

- BIANCO INTONACO/WHITE
- NERO CARAVAGGIO BLACK
- ORO CALIFORNIA/GOLD
- ARAMEN COPPER
- GRIGIO AVIO GREY AVIO
- ARGENTO COMETA/SILVER COMET
- OTTONE VENEZIANO/VENETIAN BRASS

COMPOSIZIONE C1 120 cm / 60 cm
COMPOSIZIONE C2 160 cm / 80 cm

CODICE CODE	CODICE CODE
405503C1	405503C2
405504C1	405504C2
405509C1	405509C2
405510C1	405510C2
405511C1	405511C2
405512C1	405512C2
405513C1	405513C2

ATTENZIONE/PLEASE NOTE: SU RICHIESTA DIAMETRO CUSTOM / CUSTOM DIAMETER ON REQUEST

BOX DI ALIMENTAZIONE CON FORO CENTRALE / POWER SUPPLY BOX WITH CENTRAL HOLE

TIPOLOGIA TYPE	FINITURA STRUTTURA / FINISHES				
	60W	96W	120W (2x60W)	156W	192W (2x96W)
ON/OFF	F03060	F03096	F03120	F03156	F03192
DALI	S03060	S03096	S03120	S03156	S03192

N.B.: VERSIONE 120W E 192W CONFIGURATI PER DOPPIA ACCENSIONE / PLEASE NOTE: 120W AND 192W VERSION CONFIGURED FOR DOUBLE IGNITION



“accattivante ed estremamente versatile”

DAVINCI è stato disegnato per offrire agli architetti un prodotto flessibile e in linea con i migliori sistemi tecnologici. Il posizionamento dei gruppi ottici contribuiscono a ridurre l'abbagliamento e al recupero dell'efficienza illuminotecnica, rendendolo accattivante ed estremamente versatile. Viene proposto nella versione sospensione con luce diretta/indiretta e a soffitto con luce diretta. Il suo design è decisamente minimale e le sue eleganti finiture gli consentono di essere inserito in tutti gli ambienti architettonici.

DAVINCI has been design to offer a flexible product in line with the best technological systems. The positioning of the optical groups contributes to reduce every glare and recover lighting efficiency, making it attractive and extremely attractive. It's proposed in the suspended version with direct/indirect light and in the ceiling version with direct light. Its design is minimal and its elegant finishes allow it to be put in all architectural environments.



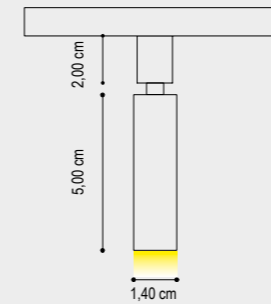

SEZIONE PROFILO/PROFILE SECTION

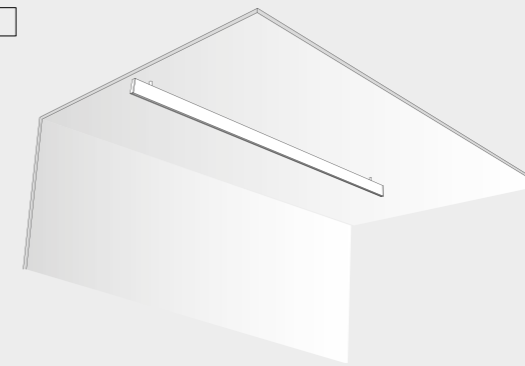

DAVINCI CON DRIVER REMOTO
DAVINCI WITH REMOTE DRIVER

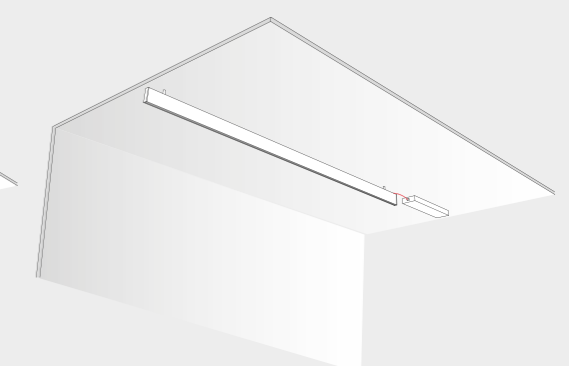

DAVINCI CON BOX
DAVINCI WITH POWER SUPPLY BOX



ARTICOLI COMPRESI NEL CODICE: SUPPORTI FISSAGGIO PLAFONE INCLUSI (DRIVER ON/OFF NON INCLUSO)
CEILING MOUNTING SUPPORTS INCLUDED (DRIVER NOT INCLUDED)

CAVO ALIMENTAZIONE TRASPARENTE: 50 cm
TRANSPARENT ALIMENTATION CABLE: 50 cm

DATI TECNICI
TECHNICAL DATA

	150 cm	200 cm	300 cm
Nominal LED Flux:	5688 lm	7584 lm	11376 lm
Flux Tot:	4550 lm	6067 lm	9100 lm
Output:	150 lm/W	150 lm/W	150 lm/W
CCT:	3000 K	3000 K	3000 K
CRI:	>90	>90	>90
Power Tot:	36.0W	48.0W	72.0W
Weight:	1.42 Kg	1.90 Kg	2.50 Kg

Profilo/Profile: Alluminio/aluminum

Cover: Satinata/satin

FINITURA STRUTTURA
FINISHES

- GRIGIO VESUVIO ANTHRACITE
- ARGILLA CLAY
- BIANCO INTONACO/WHITE
- NERO CARAVAGGIO BLACK
- ORO CALIFORNIA/GOLD
- ARAMEN COPPER
- GRIGIO AVIO/GREY AVIO
- ARGENTO COMETA/SILVER COMET
- OTTONE VENEZIANO/VENETIAN BRASS
- TITANIO/TITANIUM
- BRONZO RIACI/RIACI BRONZE
- TERRA SENESE SENESE EARTH
- CROMO CHROME

	150 cm	200 cm	300 cm
CODICE CODE	CODICE CODE	CODICE CODE	CODICE CODE
405500S150	405500S200	405500S300	
405501S150	405501S200	405501S300	
405503S150	405503S200	405503S300	
405504S150	405504S200	405504S300	
405509S150	405509S200	405509S300	
405510S150	405510S200	405510S300	
405511S150	405511S200	405511S300	
405512S150	405512S200	405512S300	
405513S150	405513S200	405513S300	
405514S150	405514S200	405514S300	
405515S150	405515S200	405515S300	
405517S150	405517S200	405517S300	
405508S150	405508S200		

BOX DI ALIMENTAZIONE / POWER SUPPLY BOX



	96W - ON/OFF (Ln 325 x Lr 75 x H 25) mm	120W - ON/OFF (Ln 374 x Lr 77 x H 35) mm	100W - DALI PUSH (Ln 374 x Lr 77 x H 35) mm	150W - DALI PUSH (Ln 374 x Lr 77 x H 35) mm
FINITURA FINISHES	CODICE CODE	CODICE CODE	CODICE CODE	CODICE CODE
BIANCO INTONACO/WHITE	10403096	10403120	10403100	10403150
NERO CARAVAGGIO/BLACK	10404096	10404120	10404100	10404150



“migliori standard illuminotecnici”

MICHELANGELO è un progetto talentuoso realizzato grazie alla continua ricerca del design e al saper fare della nostra azienda. Adotta i migliori sistemi tecnologici disponibili in materia di salvaguardia dell'ambiente. Infatti, il particolare posizionamento dei gruppi ottici concepiti per recuperare i flussi luminosi e ridurre l'abbagliamento gli consentono di raggiungere i migliori standard illuminotecnici. Disegnato per garantire ai progettisti un prodotto minimale con un accentuato senso decorativo la varietà delle finiture lo rendendolo accattivante ed estremamente versatile al punto da consentire ai lighting designer di adottarlo in tutti gli spazi architettonici, siano essi moderni, classici, luxury che futuristici.

MICHELANGELO is a talented project created thanks to the continuous research and know-how of our company. It has got the best technological system available for the environment: the particular positioning of the optical groups has been designed to recover the luminous flux and reduce glare; this allows MICHELANGELO to reach the best lighting standards.

It's a minimal product with a high decorative sense, the many finishes make it attractive and extremely versatile to the point of allowing designers to adopt it in all architectural spaces, whether modern, classic, luxury or futuristic.



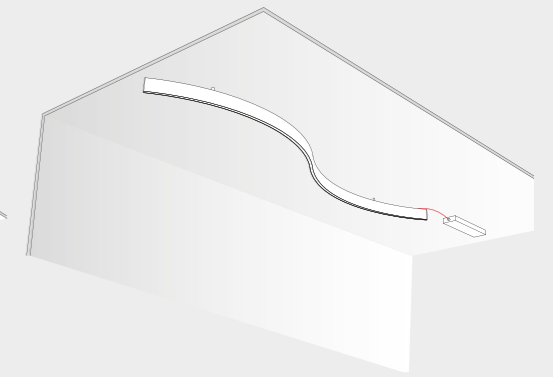
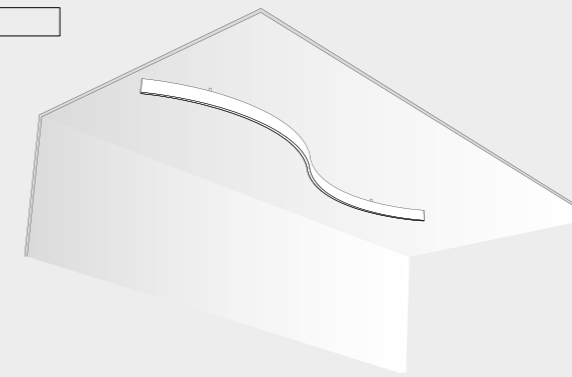
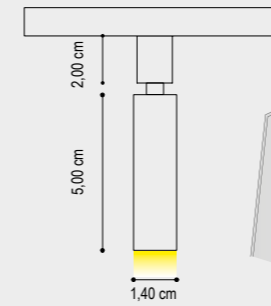

SEZIONE PROFILO/PROFILE SECTION

MICHELANGELO CON DRIVER REMOTO
MICHELANGELO WITH REMOTE DRIVER

MICHELANGELO CON BOX
MICHELANGELO WITH POWER SUPPLY BOX



DRIVER 24V ON/OFF NON INCLUSO/ NOT INCLUDED
DRIVER DA PAG. 828 - 829

SUPPORTI FISSAGGIO PLAFONE INCLUSI
CEILING MOUNTING SUPPORTS INCLUDED

ARTICOLI COMPRESI NEL CODICE:
ITEMS INCLUDED IN THE CODE:
CAVO ALIMENTAZIONE: 50 cm
ALIMENTATION CABLE: 50 cm

DATI TECNICI
TECHNICAL DATA

	150 cm	200 cm	300 cm
Nominal LED Flux:	6794 lm	8374 lm	12324 lm
Flux Tot:	5435 lm	6700 lm	9860 lm
Output:	158 lm/W	158 lm/W	158 lm/W
CCT:	3000 K	3000 K	3000 K
CRI:	>90	>90	>90
Power Tot:	43.0W	53.0W	78.0W
Weight:	1.42 Kg	1.90 Kg	2.50 Kg

Profilo/Profile: Alluminio/aluminum

Cover: Satinata/satin

FINITURA STRUTTURA
FINISHES

- GRIGIO VESUVIO ANTHRACITE
- ARGILLA CLAY
- BIANCO INTONACO/WHITE
- NERO CARAVAGGIO BLACK
- ORO CALIFORNIA/GOLD
- ARAMEN COPPER
- GRIGIO AVIO GREY AVIO
- ARGENTO COMETA/SILVER COMET
- OTTONE VENEZIANO VENETIAN BRASS
- TITANIO/TITANIUM
- BRONZO RIACI/RIACI BRONZE
- TERRA SENESE SENESE EARTH
- CROMO CHROME

	150 cm	200 cm	300 cm
CODICE CODE	CODICE CODE	CODICE CODE	CODICE CODE
405500C150	405500C200	405500C300	
405501C150	405501C200	405501C300	
405503C150	405503C200	405503C300	
405504C150	405504C200	405504C300	
405509C150	405509C200	405509C300	
405510C150	405510C200	405510C300	
405511C150	405511C200	405511C300	
405512C150	405512C200	405512C300	
405513C150	405513C200	405513C300	
405514C150	405514C200	405514C300	
405515C150	405515C200	405515C300	
405517C150	405517C200	405517C300	
405508C150	405508C200		

BOX DI ALIMENTAZIONE / POWER SUPPLY BOX



	96W - ON/OFF (Ln 325 x Lr 75 x H 25) mm	120W - ON/OFF (Ln 374 x Lr 77 x H 35) mm	100W - DALI PUSH (Ln 374 x Lr 77 x H 35) mm	150W - DALI PUSH (Ln 374 x Lr 77 x H 35) mm
FINITURA FINISHES	CODICE CODE	CODICE CODE	CODICE CODE	CODICE CODE
BIANCO INTONACO/WHITE	10403096	10403120	10403100	10403150
NERO CARAVAGGIO BLACK	10404096	10404120	10404100	10404150



“concepito per le esigenze espositive più complicate”

Un profilo con l'orientabilità di un proiettore. LINK è stato concepito per le esigenze espositive più sofisticate. Consente una illuminazione uniforme della parete o dello scaffale, nella misura richiesta. I suoi due elementi metallici di dimensioni ridotte lo rendono elegante e pulito. Con link si evita lo sgradevole effetto scalloping. L'elemento superiore può contenere alimentazione e cablaggio.

A light profile adjustable as a point. LINK is planned for sophisticated exhibition needs. For an uniform light on walls or shelves, in the perfect length. Composed by two small metallic parts, it is soft and elegant. Link is perfect to avoid scalloping effect on the wall. The upper part could contain ballasts and wiring.

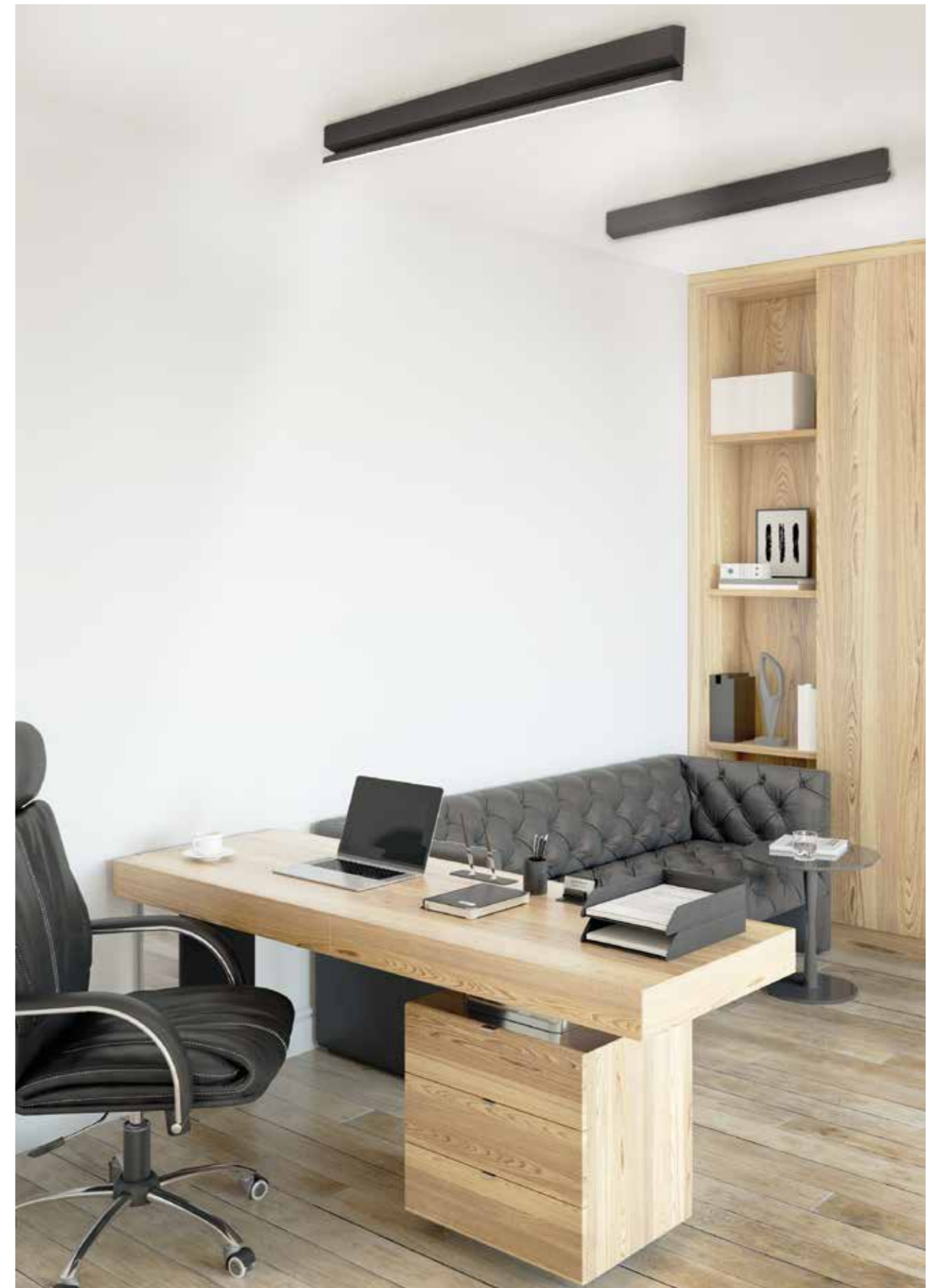

link

scheda tecnica



DATI TECNICI
TECHNICAL DATA

	1 cm - 24W/m	1 cm - 30W/m
Nominal LED Flux:	2975 lm/m	3150 lm/m
Flux Tot:	2380 lm/m	2550 lm/m
Output:	125 lm/W	105 lm/W
CCT:	3000 K	3000 K
CRI:	>95	>90
Power Tot:	24.0W/m	30.0W/m
Weight:	1.90 Kg/m	1.90 Kg/m

Profilo/Profile: Alluminio/aluminum Cover: Opale/opal

DRIVER 24V NON INCLUSO / NOT INCLUDED

LUNGHEZZA CAVO ALIMENTAZIONE: 50 cm
ALIMENTATION CABLE LENGTH: 50 cm

FINITURA STRUTTURA
FINISHES

- GRIGIO VESUVIO ANTHRACITE
- ARGILLA CLAY
- BIANCO INTONACO/WHITE
- NERO CARAVAGGIO BLACK
- MOKA MOCHA
- CROMO/CHROME
- ORO CALIFORNIA/GOLD
- ARGENTO COMETA/SILVER COMET
- OTTONE VENEZIANO/VENETIAN BRASS
- TERRA SENESE SENESE EARTH

DIFFUSORE
DIFFUSER

OPALE/OPAL

24W/m

30W/m

CODICE CODE	CODICE CODE
117H700001	1178100001
117H701001	1178101001
117H703001	1178103001
117H704001	1178104001
117H705001	1178105001
117H708001	1178108001
117H709001	1178109001
117H712001	1178112001
117H713001	1178113001
117H717001	1178117001

ATTENZIONE/PLEASE NOTE:

LUNGHEZZA MASSIMA VERSIONE CROMO = 2,00 m / MAXIMUM LENGTH CHROME VERSION = 2.00 m

TESTATE DI CHIUSURA / DEAD ENDS

FINITURA STRUTTURA FINISHES	CODICE CODE	FINITURA STRUTTURA FINISHES	CODICE CODE
GRIGIO VESUVIO ANTHRACITE	1170400000	ORO CALIFORNIA GOLD	1170409000
ARGILLA CLAY	1170401000	ARGENTO COMETA/SILVER COMET	1170412000
BIANCO INTONACO/WHITE	1170403000	OTTONE VENEZIANO/VENETIAN BRASS	1170413000
NERO CARAVAGGIO BLACK	1170404000	TERRA SENESE SENESE EARTH	1170417000
MOKA MOCHA	1170405000		
CROMO/CHROME	1170408000		

Nel codice sono comprese le viti per il fissaggio delle testate al profilo. Il codice contiene n° 2 testate di chiusura.
The code includes the screws for fixing the heads to the profile. The code contains 2 closing warheads

CODICE
CODE

1050A



MONTAGGIO CABLAGGIO COLLAUDO CE DRIVER 50W / MOUNTING WIRING TESTING CE MARKING DRIVER 50W



link 50/100/200

scheda tecnica



DATI TECNICI
TECHNICAL DATA

	50 cm	100 cm	200 cm
Nominal LED Flux:	1260 lm	2975 lm/m	5040 lm
Flux Tot:	1008 lm	2380 lm/m	4032 lm
Output:	105 lm/W	125 lm/W	105 lm/W
CCT:	3000 K	3000 K	3000 K
CRI:	>95	>95	>95
Power Tot:	12.0W	24.0W/m	48.0W
Weight:	0.85 Kg	1.90 Kg	3.40 Kg

Profilo/Profile: Alluminio/aluminum Cover: Satinata/satin

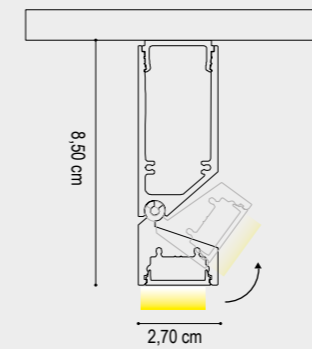

LUNGHEZZA CAVO ALIMENTAZIONE: 50 cm
ALIMENTATION CABLE LENGTH: 50 cm
Cavo: 2x0.75mm / Wire: 2x0.75mm

ARTICOLI INCLUSI NEL CODICE / ITEMS INCLUDED IN THE CODE:
DRIVER 24V ON/OFF / DRIVER ON/OFF INCLUDED
COPPIA DI TESTATE DI CHIUSURA / PAIR OF CLOSING HEADS

FINITURA STRUTTURA
FINISHES

- GRIGIO VESUVIO ANTHRACITE
- ARGILLA CLAY
- BIANCO INTONACO/WHITE
- NERO CARAVAGGIO BLACK
- MOKA MOCHA
- CROMO/CHROME
- ORO CALIFORNIA/GOLD
- ARAMEN COPPER
- ARGENTO COMETA/SILVER COMET
- OTTONE VENEZIANO BRASS
- TITANIO/TITANIUM
- BRONZO RIACI/RIACI BRONZE
- VERDE COSTA/GREEN COAST
- TERRA SENESE SENESE EARTH

DIFFUSORE
DIFFUSER

SATINATA/SATIN

CODICE CODE	CODICE CODE	CODICE CODE
117H700050	117H700100	117H700200
117H701050	117H701100	117H701200
117H703050	117H703100	117H703200
117H704050	117H704100	117H704200
117H705050	117H705100	117H705200
117H708050	117H708100	117H708200
117H709050	117H709100	117H709200
117H710050	117H710100	117H710200
117H712050	117H712100	117H712200
117H713050	117H713100	117H713200
117H714050	117H714100	117H714200
117H715050	117H715100	117H715200
117H716050	117H716100	117H716200
117H717050	117H717100	117H717200

“concepito per le esigenze espositive più complicate”

Un profilo con l'orientabilità di un proiettore. LINK Point è stato concepito per le esigenze espositive più sofisticate. Consente una illuminazione uniforme della parete o dello scaffale, nella misura richiesta. I suoi due elementi metallici di dimensioni ridotte lo rendono elegante e pulito. Con LINK Point si evita lo sgradevole effetto scalloping. L'elemento superiore può contenere alimentazione e cablaggio.

A light profile adjustable as a point. LINK Point is planned for sophisticated exhibition needs. For an uniform light on walls or shelves, in the perfect length. Composed by two small metallic parts is soft and elegant. LINK Point is perfect to avoid scalloping effect on the wall. The upper part could contain ballasts and wiring.



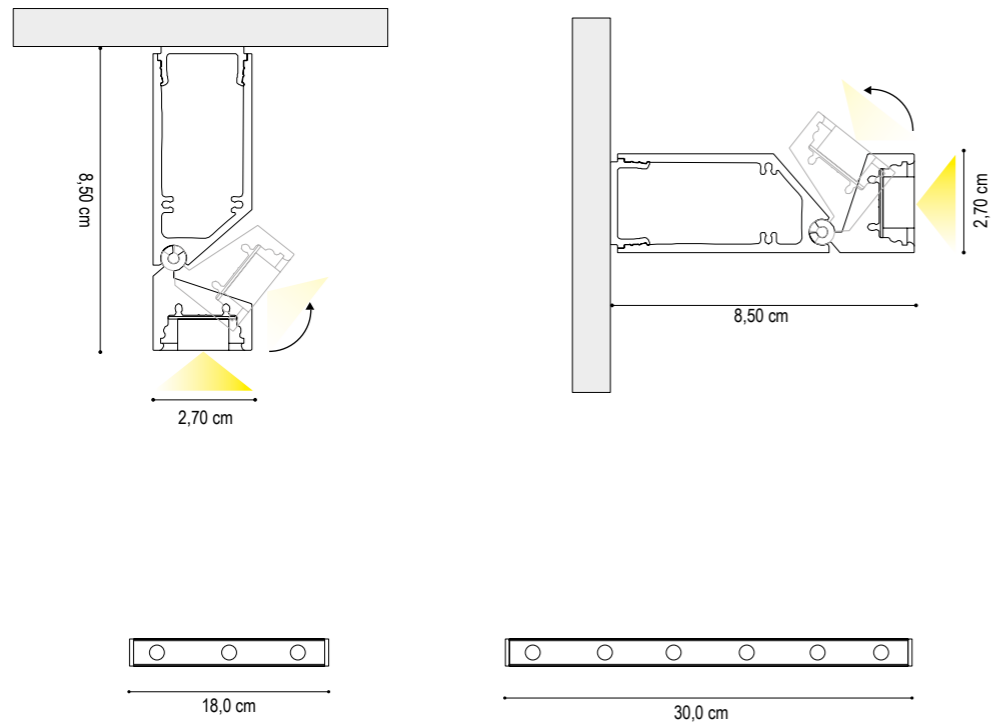

ARTICOLI INCLUSI NEL CODICE / ITEMS INCLUDED IN THE CODE:
 DRIVER 24V ON/OFF / DRIVER ON/OFF INCLUDED
 COPPIA DI TESTATE DI CHIUSURA / PAIR OF CLOSING HEADS

DATI TECNICI
 TECHNICAL DATA

	18 cm	30 cm
Nominal LED Flux:	762 lm	1524 lm
Flux Tot:	610 lm	1220 lm
Output:	121 lm/W	121 lm/W
CCT:	3000 K	3000 K
CRI:	>90	>90
Power Tot:	6.5W - DRIVER 700mA	13.0W - DRIVER 700mA
Weight:	0.35 Kg	0.70 Kg
Profilo/Profile:	Alluminio/aluminum	Cover: Opale/opal

FINITURA STRUTTURA
 FINISHES

- GRIGIO VESUVIO ANTHRACITE
- ARGILLA CLAY
- BIANCO INTONACO/WHITE
- NERO CARAVAGGIO BLACK
- MOKA MOCHA
- CROMO CHROME
- ORO CALIFORNIA/GOLD
- ARAMEN COPPER
- ARGENTO COMETA/SILVER COMET
- OTTONE VENEZIANO VENETIAN BRASS
- TITANIO/TITANIUM
- BRONZO RIACI/RIACI BRONZE
- VERDE COSTA/GREEN COAST
- TERRA SENESE SENESE EARTH
- NERO-CROMO/BLACK-CHROME

DIFFUSORE
 DIFFUSER

OPALE/OPAL

	18 cm	30 cm
CODICE CODE		
	1178400253	1178400256
	1178401253	1178401256
	1178403253	1178403256
	1178404253	1178404256
	1178405253	1178405256
	1178408253	1178408256
	1178409253	1178409256
	1178410253	1178410256
	1178412253	1178412256
	1178413253	1178413256
	1178414253	1178414256
	1178415253	1178415256
	1178416253	1178416256
	1178417253	1178417256
	1178448253	1178448256

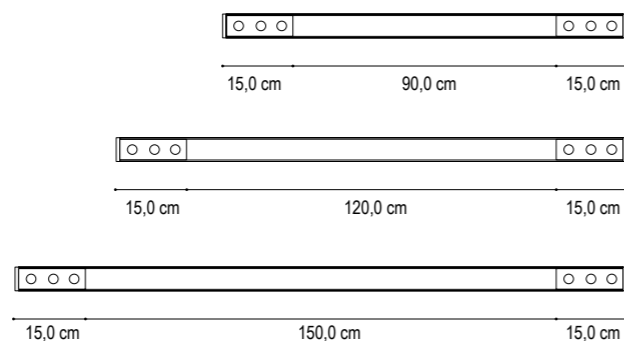
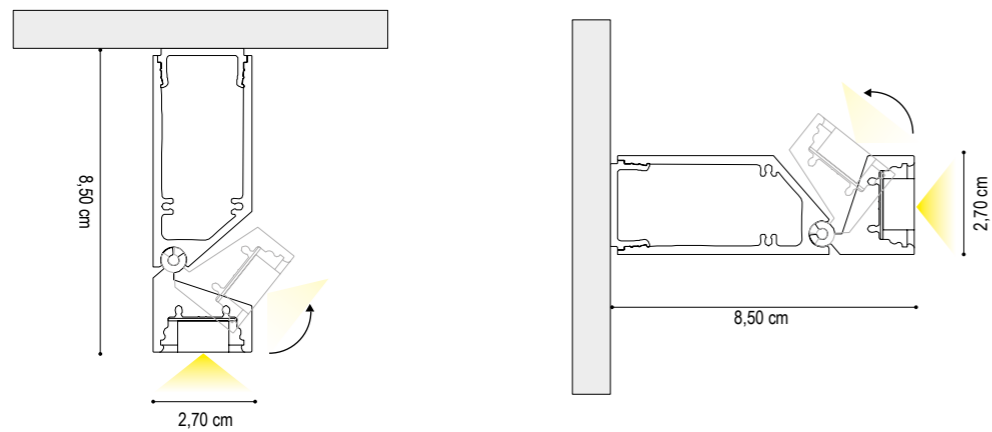

DATI TECNICI
TECHNICAL DATA

	120 cm (15+90+15)cm	150 cm (15+120+15)cm	180 cm (15+150+15)cm
Nominal LED Flux:	1890 lm	2520 lm	3150 lm
Nominal SPOT Flux:	1524 lm	1524 lm	1524 lm
Flux Tot:	2731 lm	3235 lm	3739 lm
Output:	105 lm/W + 121 lm/W	105 lm/W + 121 lm/W	105 lm/W + 121 lm/W
CCT:	3000 K	3000 K	3000 K
CRI:	>95	>95	>95
LED Power Tot:	18.0W	24.0W	30.0W
SPOT Power Tot:	18.0W (3W x 6)	18.0W (3W x 6)	18.0W (3W x 6)
Weight:	2.04 Kg	2.55 Kg	3.06 Kg
Profilo/Profile: Alluminio/aluminum			Cover: Opale/opal

ARTICOLI INCLUSI NEL CODICE / ITEMS INCLUDED IN THE CODE:
DRIVER 24V ON/OFF / DRIVER ON/OFF INCLUDED
COPPIA DI TESTATE DI CHIUSURA / PAIR OF CLOSING HEADS

FINITURA STRUTTURA
FINISHES

- GRIGIO VESUVIO ANTHRACITE
- ARGILLA CLAY
- BIANCO INTONACO/WHITE
- NERO CARAVAGGIO BLACK
- MOKA MOCHA
- CROMO CHROME
- ORO CALIFORNIA/GOLD
- ARAMEN COPPER
- ARGENTO COMETA/SILVER COMET
- OTTONE VENEZIANO VENETIAN BRASS
- TITANIO/TITANIUM
- BRONZO RIACI/RIACI BRONZE
- VERDE COSTA/GREEN COAST
- TERRA SENESE SENESE EARTH
- NERO-CROMO BLACK-CHROME

DIFFUSORE
DIFFUSER

OPALE/OPAL

	120 cm (15+90+15)cm	150 cm (15+120+15)cm	180 cm (15+150+15)cm
CODICE CODE	CODICE CODE	CODICE CODE	CODICE CODE
	1178400120	1178400150	1178400180
	1178401120	1178401150	1178401180
	1178403120	1178403150	1178403180
	1178404120	1178404150	1178404180
	1178405120	1178405150	1178405180
	1178408120	1178408150	1178408180
	1178409120	1178409150	1178409180
	1178410120	1178410150	1178410180
	1178412120	1178412150	1178412180
	1178413120	1178413150	1178413180
	1178414120	1178414150	1178414180
	1178415120	1178415150	1178415180
	1178416120	1178416150	1178416180
	1178417120	1178417150	1178417180
	1178448120	1178448150	1178448180



“profilo in alluminio estruso che scompare nella muratura”

I tagli di luce LED permettono di creare effetti di luce o di illuminare ambienti in modi del tutto nuovi utilizzando pareti e soffitti. T24 è un profilo in alluminio estruso che scompare nella muratura lasciando a vista solo il diffusore. Facile da installare e progettato con i migliori sistemi ottici atti a garantire la perfetta illuminazione degli spazi.

The LED light cuts allow you to create lighting effects or to illuminate environments in completely new ways using walls and ceilings. T24 is an extruded aluminum profile that disappears into the masonry leaving only the diffuser visible. Easy to install and designed with the best optical systems to ensure perfect lighting of spaces.





t24 - m24

t24 - m24

configurazioni

configurations

ATTENZIONE! GLI ACCESSORI PER L'INSTALLAZIONE A INCASSO SONO STATI DIMENSIONATI PER UN PANNELLO STANDARD IN CARTONGESSO DI SPESSORE 12,5 mm
WARNING! THE BUILT-IN INSTALLATION ACCESSORIES HAVE BEEN DIMENSIONED FOR A STANDARD PLASTERBOARD PANEL OF 12.5 mm THICKNESS

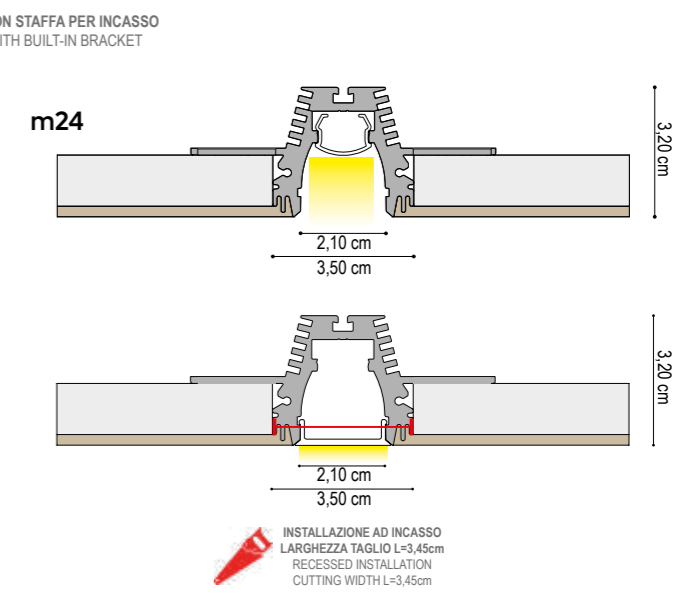
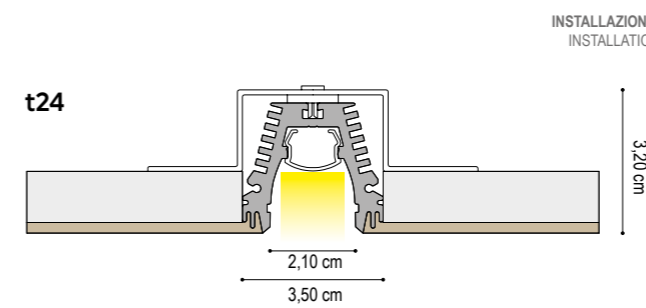
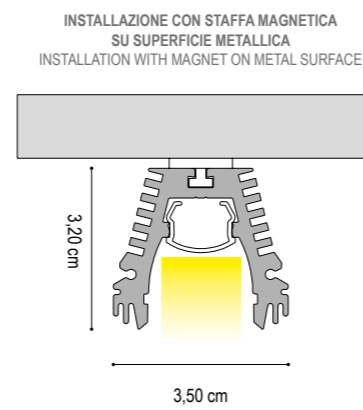
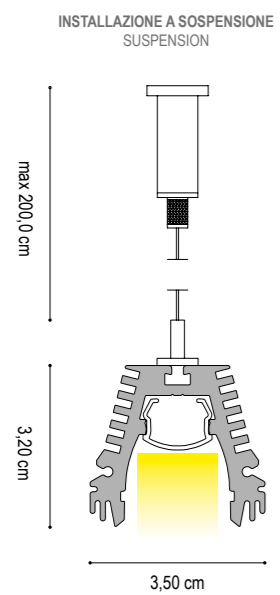

t24

led integrato

integrated led

TIPOLOGIE INSTALLAZIONE / TYPES OF INSTALLATION
 SOSPENSIONE / SUSPENSION
 SOFFITTO / CEILING
 INCASSO / RECESSED

DRIVER NON INCLUSO / NOT INCLUDED

LUNGHEZZA CAVO ALIMENTAZIONE: 50 cm
 ALIMENTATION CABLE LENGTH: 50 cm

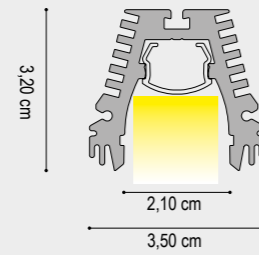

DATI TECNICI
 TECHNICAL DATA

COVER RECESSA / RECESSED DIFFUSER

	1 cm
Nominal LED Flux:	2975 lm/m
Flux Tot:	2380 lm/m
Output:	125 lm/W
CCT:	3000 K
CRI:	>95
Power Tot:	24.0W/m
Weight:	1.20 Kg/m

Profilo/Profile: Alluminio/aluminum
 Cover: Opale/opal - Eclissi/eclipse

Lmax = 300 cm

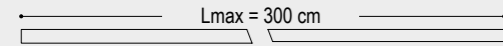

m24

led integrato

integrated led

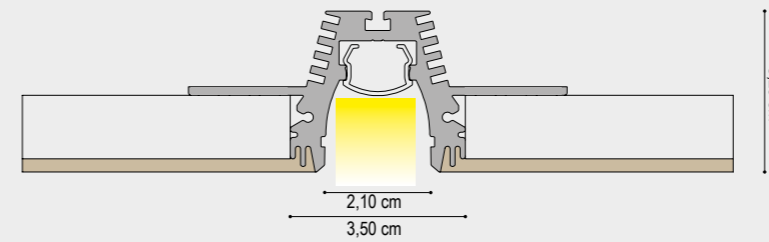

DRIVER NON INCLUSO / NOT INCLUDED

LUNGHEZZA CAVO ALIMENTAZIONE: 50 cm
 ALIMENTATION CABLE LENGTH: 50 cm

DATI TECNICI
 TECHNICAL DATA

COVER RECESSA / RECESSED DIFFUSER

	1 cm
Nominal LED Flux:	2975 lm/m
Flux Tot:	2380 lm/m
Output:	125 lm/W
CCT:	3000 K
CRI:	>95
Power Tot:	24.0W/m
Weight:	1.20 Kg/m

Profilo/Profile: Alluminio/aluminum
 Cover: Opale/opal - Eclissi/eclipse

FINITURA STRUTTURA
 FINISHES

BIANCO INTONACO/WHITE
NERO CARAVAGGIO/BLACK
ALLUMINIO NATURALE/ALUMINUM
ORO CALIFORNIA/GOLD
BIANCO INTONACO/WHITE
NERO CARAVAGGIO/BLACK
ALLUMINIO NATURALE/ALUMINUM
ORO CALIFORNIA/GOLD

DIFFUSORE
 DIFFUSER

ECLISSI ECLIPSE

OPALE/OPAL

CODICE 2700K
 CODE 2700K

24H603C001
24H604C001
24H606C001
24H609C001
24H603T001
24H604T001
24H606T001
24H609T001

CODICE 3000K
 CODE 3000K

24H703C001
24H704C001
24H706C001
24H709C001
24H703T001
24H704T001
24H706T001
24H709T001

CODICE 4000K
 CODE 4000K

24H803C001
24H804C001
24H806C001
24H809C001
24H803T001
24H804T001
24H806T001
24H809T001

TIPOLOGIE INSTALLAZIONE / TYPES OF INSTALLATION
 SOSPENSIONE / SUSPENSION
 SOFFITTO / CEILING
 INCASSO / RECESSED

DRIVER NON INCLUSO / NOT INCLUDED

LUNGHEZZA CAVO ALIMENTAZIONE: 50 cm
 ALIMENTATION CABLE LENGTH: 50 cm

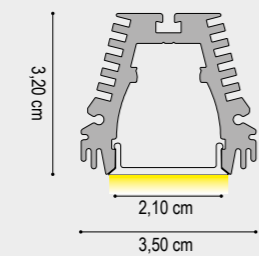

DATI TECNICI
 TECHNICAL DATA

COVER ESTERNA / EXTERNAL DIFFUSER

	1 cm
Nominal LED Flux:	2975 lm/m
Flux Tot:	2380 lm/m
Output:	125 lm/W
CCT:	3000 K
CRI:	>95
Power Tot:	24.0W/m
Weight:	1.20 Kg/m

Profilo/Profile: Alluminio/aluminum
 Cover: Opale/opal

Lmax = 300 cm

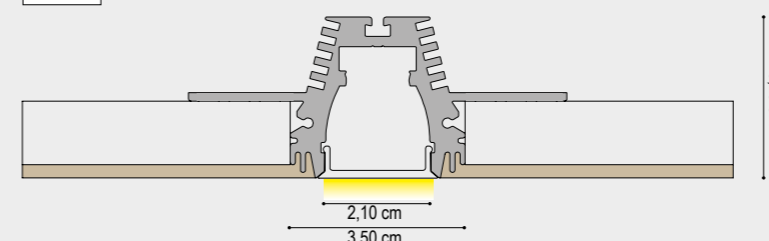
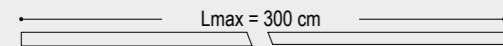

DRIVER NON INCLUSO / NOT INCLUDED

LUNGHEZZA CAVO ALIMENTAZIONE: 50 cm
 ALIMENTATION CABLE LENGTH: 50 cm

DATI TECNICI
 TECHNICAL DATA

COVER ESTERNA / EXTERNAL DIFFUSER

	1 cm
Nominal LED Flux:	2975 lm/m
Flux Tot:	2380 lm/m
Output:	125 lm/W
CCT:	3000 K
CRI:	>95
Power Tot:	24.0W/m
Weight:	1.20 Kg/m

Profilo/Profile: Alluminio/aluminum
 Cover: Opale/opal

FINITURA STRUTTURA
 FINISHES

ALLUMINIO NATURALE/ALUMINUM

DIFFUSORE
 DIFFUSER

OPALE/OPAL

CODICE 2700K
 CODE 2700K

24H606T011

CODICE 3000K
 CODE 3000K

24H706T011

CODICE 4000K
 CODE 4000K

24H806T011

NEL CODICE PROFILO È INCLUSA LA COVER POSA IN OPERA (COVER MONOUSO PER PROTEGGERE IL PROFILO DURANTE LE FASI DI INSTALLAZIONE)

THE COVER INSTALLED IS INCLUDED IN THE PROFILE CODE (DISPOSABLE COVER TO PROTECT THE PROFILE DURING THE INSTALLATION PHASES)

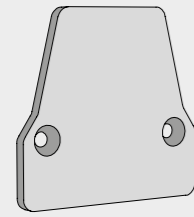

TESTATE DI CHIUSURA / DEAD ENDS

FINITURA STRUTTURA
FINISHES

BIANCO INTONACO/WHITE
NERO CARAVAGGIO/BLACK
ALLUMINIO NATURALE/ALUMINUM
ORO CALIFORNIA/GOLD

CODICE
CODE

240403
240404
240406
240409

Nel codice sono comprese le viti per il fissaggio delle testate al profilo. Il codice contiene n° 1 testate di chiusura.
The code includes the screws for fixing the heads to the profile. The code contains 1 closing warheads

GIUNTI / JOINTS

GIUNTO LINEA CONTINUA / STRAIGHT JOINT

Accessorio per giunzioni meccaniche lineari
Accessory for linear mechanical joints

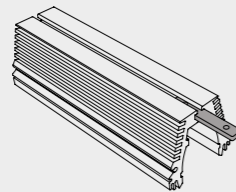
FINITURA
FINISHES

ALLUMINIO NATURALE/ALUMINUM

CODICE
CODE

1010500006

GIUNTO 90° ORIZZONTALE / HORIZONTAL JOINT 90°

Accessorio per giunzioni meccaniche con angolo 90°
Accessory for linear mechanical joints with 90° angle

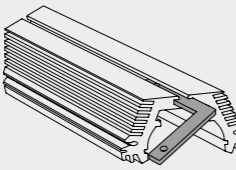

ALLUMINIO NATURALE/ALUMINUM

1010500005

GIUNTO 90° VERTICALE / VERTICAL JOINT 90°

Accessorio per giunzioni meccaniche con angolo 90°
Accessory for linear mechanical joints with 90° angle

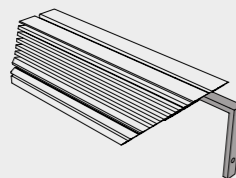

ALLUMINIO NATURALE/ALUMINUM

1010500007

Nel codice sono compresi i grani per il fissaggio del giunto / The code includes the grains for fixing the joint.

STAFFA DI FISSAGGIO / MOUNTING CLIP

FINITURA
FINISHESSUPERFICI PIANE 2mm
EVEN SURFACE 2mmCODICE
CODE

1020500003

SUPERFICI IRREGOLARI 3,5mm
UNEVEN SURFACE 3,5mm

1020500004

Accessorio per fissaggio a plafone/superficie. Quantità raccomandata: 1 pz ogni 50 cm di profilo
Ceiling/surface mounting accessory. Recommended quantity: 1 pc every 50 cm of profile

CALAMITA / MAGNET

CODICE
CODE

102050001

1020500210

PORTATA
RANGE

1 Kg

2 Kg

Quantità raccomandata: 1 pz ogni 25cm di profilo
Recommended quantity: 1 pc every 25cm of profile

KIT DI SOSPENSIONE / SUSPENSION KIT

DATI TECNICI
TECHNICAL DATA

ARTICOLI INCLUSI NEL CODICE
ARTICLES INCLUDED IN THE CODE

Cavo in acciaio 2,00m con puntalino
2.00m steel cable with tip
Boccola cromata con regolazione millimetrica
Chrome bush with millimeter adjustment
Archetto in alluminio per sospensione
Aluminum arch for suspension

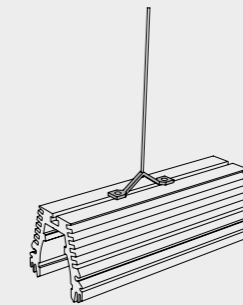
FINITURA STRUTTURA
FINISHES

BIANCO INTONACO/WHITE

NERO CARAVAGGIO/BLACK

ALLUMINIO NATURALE/ALUMINUM

ORO CALIFORNIA/GOLD

CODICE
CODE

1040503004

1040504004

1040506004

1040509004

STAFFA DI FISSAGGIO A CARTONGESSO PER T24 / PLASTERBOARD FIXING BRACKET FOR T24

Accessorio che consente l'incasso del profilo.
Accessory that allows the collection of the profile

Nel codice sono comprese le viti per il fissaggio del profilo alla staffa.
The code includes screws for fixing the profile to the bracket

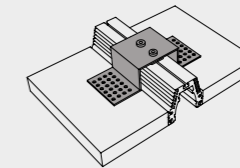
FINITURA
FINISHES

ALLUMINIO NATURALE/ALUMINUM

CODICE
CODE

240502

LAVORAZIONI / PROCESSING

DATI TECNICI
TECHNICAL DATA

TAGLIO 90° ORIZZONTALE (PER ANGOLI FORMATI DA DUE PROFILI)
HORIZONTAL 90 ° CUT (FOR CORNERS MADE OF TWO PROFILES)

190X

TAGLIO 90° VERTICALE (PER ANGOLI FORMATI DA DUE PROFILI)
VERTICAL 90 ° CUT (FOR CORNERS MADE OF TWO PROFILES)

190Y

TAGLIO ANGOLARE CUSTOM (PER ANGOLI FORMATI DA DUE PROFILI)
CUSTOM CORNER CUT (FOR CORNERS MADE OF TWO PROFILES)

190N

ASOLA / SLOT STANDARD 2x3

100A

FORO / HOLE

100F

ASOLA / SLOT NON STANDARD

100N

**“pensati allo scopo di illuminare
in modo deciso e netto gli angoli chiusi e aperti”**

Le società moderne tendono a trasformare sempre di più i luoghi in ambienti confortevoli siano essi dedicati al lavoro al relax o allo shopping. La luce ha un ruolo fondamentale per creare scenografie che trasmettono benessere, calore ed emozioni, essa influenza positivamente la sfera emozionale delle persone che li vivono. IN e OUT sono stati pensati allo scopo di illuminare in modo deciso e netto gli angoli chiusi e aperti, molto presenti nel costruito, ma spesso non bene illuminati. Le due soluzioni disegnate per consentire ai progettisti di creare negli ambienti linee luminose in grado di evidenziarne gli aspetti, rendendoli più visibili eleganti e dall'aspetto futuristico.

Modern societies tend to increasingly transform places into comfortable environments whether they are dedicated to work, relaxation or shopping. Light plays a fundamental role in creating scenographies that transmit well-being, warmth and emotions, it positively influences the emotional sphere of the people who live them. IN and OUT - have been designed with the aim of clearly and decisively illuminating closed and open corners, very present in the building, but often not well lit. The two solutions designed to allow designers to create luminous lines in the rooms that are able to highlight their aspects, making them more visible, elegant and with a futuristic appearance.



in

installazione

installation

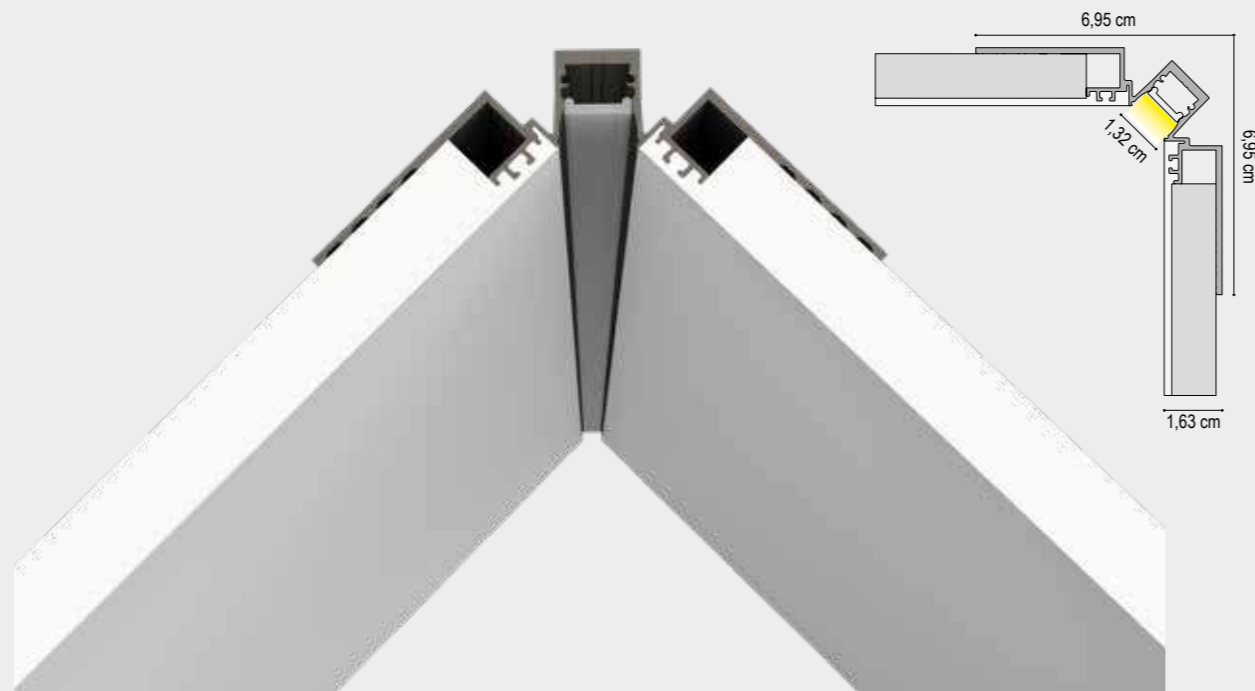

in

installazione

installation

ATTENZIONE! IL PROFILO E' STATO DIMENSIONATO PER UN PANNELLO STANDARD IN CARTONGESSO DI SPESSORE 12,5 mm

WARNING! THE PROFILE HAS BEEN SIZED FOR A STANDARD PLASTERBOARD PANEL OF 12.5 mm THICKNESS

DRIVER NON INCLUSO / NOT INCLUDED

LUNGHEZZA CAVO ALIMENTAZIONE: 50 cm
ALIMENTATION CABLE LENGTH: 50 cm

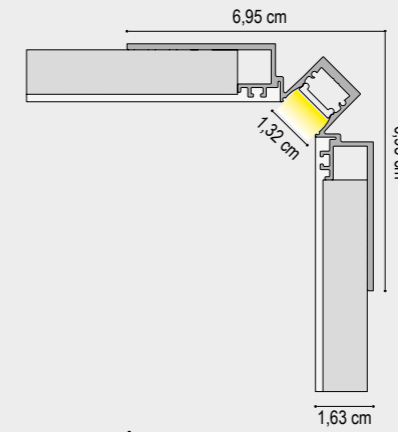

DATI TECNICI
TECHNICAL DATA

1 cm	
Nominal LED Flux:	2975 lm/m
Flux Tot:	2380 lm/m
Output:	125 lm/W
CCT:	3000 K
CRI:	>95
Power Tot:	24.0W/m
Weight:	0.50 Kg/m

Profilo/Profile: Alluminio/aluminum
Cover: Opale/opal - Eclissi/eclipse

Lmax = 300 cm

FINITURA STRUTTURA
FINISHES

- BIANCO INTONACO/WHITE
- NERO CARAVAGGIO/BLACK**
- ALLUMINIO NATURALE/ALUMINUM
- BIANCO INTONACO/WHITE
- NERO CARAVAGGIO/BLACK**
- ALLUMINIO NATURALE/ALUMINUM
- ORO CALIFORNIA/GOLD**

DIFFUSORE
DIFFUSER

ECLISSI/ECLIPSE

OPALE/OPAL

1 cm

CODICE 2700K
CODE 2700K
28H603C001
28H604C001
28H606C001
28H603N001
28H604N001
28H606N001
28H609N001

1 cm

CODICE 3000K
CODE 3000K
28H703C001
28H704C001
28H706C001
28H703N001
28H704N001
28H706N001
28H709N001

1 cm

CODICE 4000K
CODE 4000K
28H803C001
28H804C001
28H806C001
28H803N001
28H804N001
28H806N001
28H809N001

out

installazione

installation

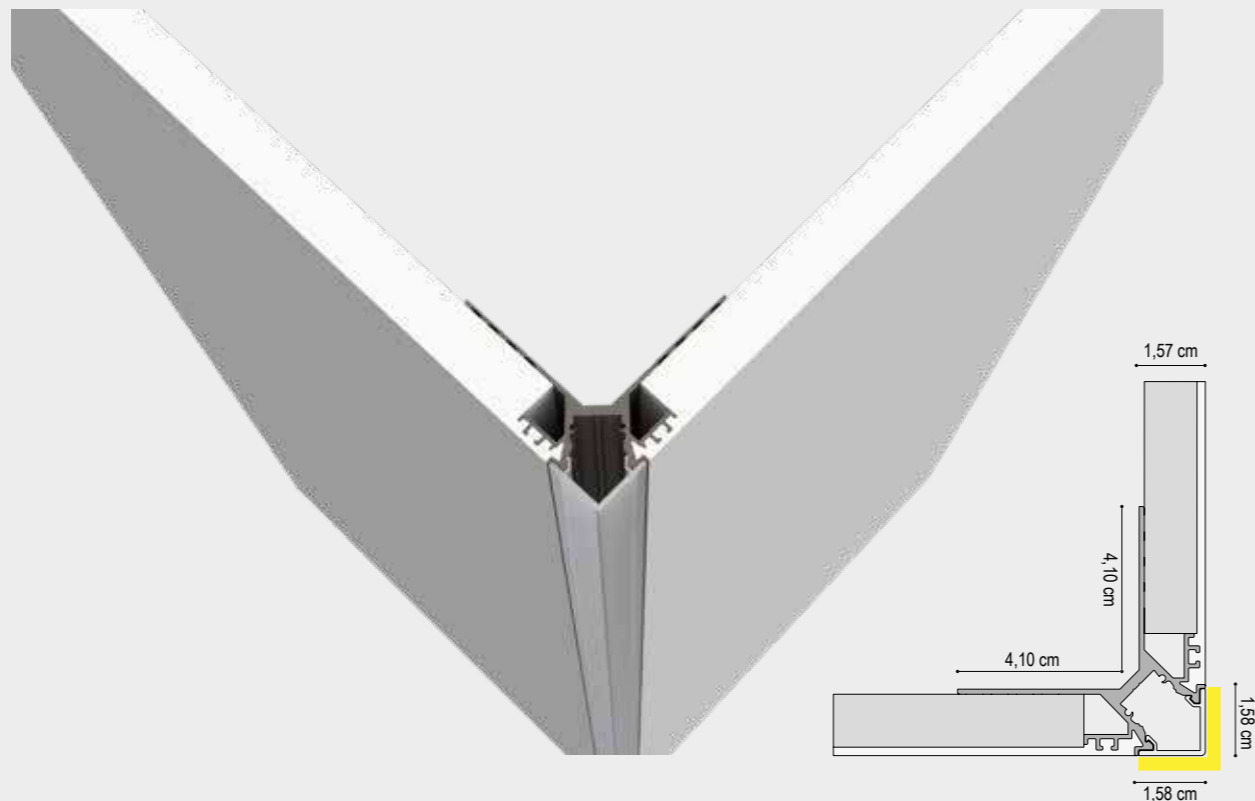

out

led integrato

integrated led

ATTENZIONE! IL PROFILO E' STATO DIMENSIONATO PER UN PANNELLO STANDARD IN CARTONGESSO DI SPESSORE 12,5 mm

WARNING! THE PROFILE HAS BEEN SIZED FOR A STANDARD PLASTERBOARD PANEL OF 12.5 mm THICKNESS

DRIVER NON INCLUSO / NOT INCLUDED

LUNGHEZZA CAVO ALIMENTAZIONE: 50 cm
ALIMENTATION CABLE LENGTH: 50 cm

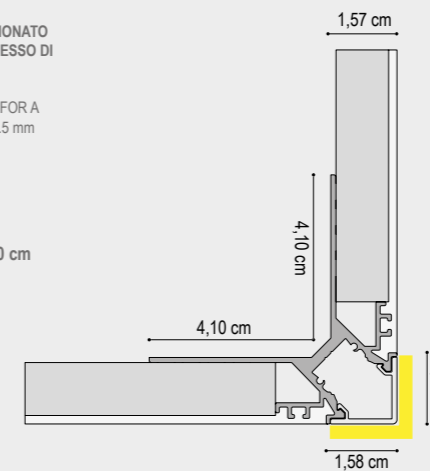

DATI TECNICI
TECHNICAL DATA

1 cm	
Nominal LED Flux:	2975 lm/m
Flux Tot:	2380 lm/m
Output:	125 lm/W
CCT:	3000 K
CRI:	>95
Power Tot:	24.0W/m
Weight:	0.50 Kg/m

Profilo/Profile: Alluminio/aluminum
Cover: Opale/opal - Eclissi/eclipse

Lmax = 300 cm

FINITURA STRUTTURA
FINISHES

ALLUMINIO NATURALE/ALUMINUM

DIFFUSORE
DIFFUSER

OPALE/OPAL

1 cm

CODICE 2700K
CODE 2700K
28H606T001

1 cm

CODICE 3000K
CODE 3000K
28H706T001

1 cm

CODICE 4000K
CODE 4000K
28H806T001



in

profilo e cover

profile and diffuser

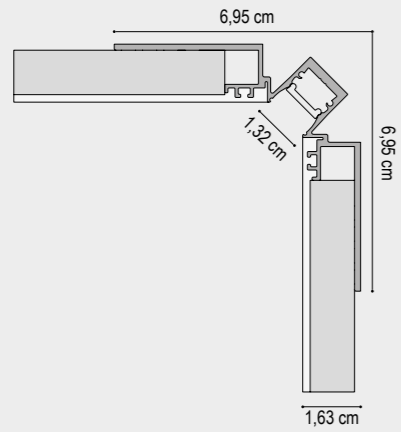

ATTENZIONE! IL PROFILO E' STATO DIMENSIONATO PER UN PANNELLO STANDARD IN CARTONGESSO DI SPESSORE 12,5 mm
WARNING! THE PROFILE HAS BEEN SIZED FOR A STANDARD PLASTERBOARD PANEL OF 12.5 mm THICKNESS

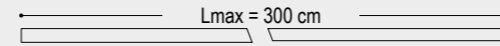

FINITURA STRUTTURA
FINISHES

BIANCO INTONACO/WHITE
NERO CARAVAGGIO BLACK
ALLUMINIO NATURALE/ALUMINUM
BIANCO INTONACO/WHITE
NERO CARAVAGGIO BLACK
ALLUMINIO NATURALE/ALUMINUM

DIFFUSORE
DIFFUSER

ECLISSI/ECLIPSE
OPALE/OPAL

	1 cm	200 cm	300 cm
CODICE CODE	CODICE CODE	CODICE CODE	CODICE CODE
280303C001	280303C200	280303C300	
280304C001	280304C200	280304C300	
280306C001	280306C200	280306C300	
280303N001	280303N200	280303N300	
280304N001	280304N200	280304N300	
280306N001	280306N200	280306N300	

out

profilo e cover

profile and diffuser

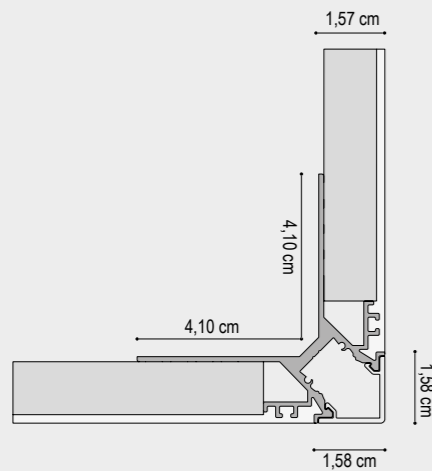

ATTENZIONE! IL PROFILO E' STATO DIMENSIONATO PER UN PANNELLO STANDARD IN CARTONGESSO DI SPESSORE 12,5 mm
WARNING! THE PROFILE HAS BEEN SIZED FOR A STANDARD PLASTERBOARD PANEL OF 12.5 mm THICKNESS

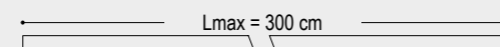

FINITURA STRUTTURA
FINISHES

ALLUMINIO NATURALE/ALUMINUM

DIFFUSORE
DIFFUSER

OPALE/OPAL

	1 cm	200 cm	300 cm
CODICE CODE	CODICE CODE	CODICE CODE	CODICE CODE
280306T001	280306T200	280306T300	

out

led integrated

integrated led

LED compatibili / LED compatibility

HIGH QUALITY CRI>90 CRI>95	HIGH OUTPUT CRI>90 CRI>95	HIGH EFFICIENT CRI>90 CRI>95	HIGH INTENSITY CRI>90 CRI>95	LOW POWER CRI>90	ULTRA SLIM CRI>90 CRI>95 CRI>97	RGB	RGB WHITE	RGB TW	TUNABLE WHITE
9,6W 14,4W 19,2W	12,3W 14,4W 19,2W 20W 24W	12,3W 14,4W 19,2W 20W 24W	24W 24W (700 LED)	6W	9,6W 12W 14,4W	14W	14W	14,4W 23W	19,2W

in

accessori

accessories

TESTATE DI CHIUSURA / DEAD ENDS

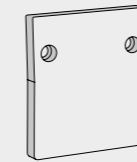

FINITURA STRUTTURA
FINISHES

BIANCO INTONACO/WHITE
NERO CARAVAGGIO BLACK
ORO CALIFORNIA GOLD
ALLUMINIO NATURALE/ALUMINUM

CODICE
CODE

280403N
280404N
280409N
280406N

Nel codice sono comprese le viti per il fissaggio delle testate al profilo. Il codice contiene n° 1 testate di chiusura.
The code includes the screws for fixing the heads to the profile. The code contains 1 closing warheads

out

accessori

accessories

TESTATE DI CHIUSURA / DEAD ENDS

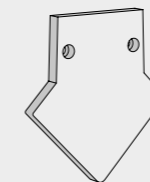

FINITURA STRUTTURA
FINISHES

BIANCO INTONACO/WHITE
NERO CARAVAGGIO BLACK
ALLUMINIO NATURALE/ALUMINUM

CODICE
CODE

280403U
280404U
280406U

Nel codice sono comprese le viti per il fissaggio delle testate al profilo. Il codice contiene n° 1 testate di chiusura.
The code includes the screws for fixing the heads to the profile. The code contains 1 closing warheads

LAVORAZIONI / PROCESSING

DATI TECNICI TECHNICAL DATA	CODICE CODE
ASOLA / SLOT	100A
FORO / HOLE	100F
CABLAGGIO - COLLAUDO - CE AL CENTIMETRO INSTALLATION AND TESTING LED MODULE AT CENTIMETER	2801

**“luce radente,
illuminazione perfetta”**

Il sistema KEPLER è un profilo in alluminio estruso che consente di illuminare con luce radente le pareti degli ambienti lavorativi e abitativi. Scompare nel controsoffitto, facile da installare e progettato con i migliori sistemi ottici atti a garantire la perfetta illuminazione degli spazi. Viene proposto in due versioni: con diffusore recesso per un effetto “gola luminosa” e con diffusore esterno per una continuità visiva.

The KEPLER system is an extruded aluminum profile that allows you to illuminate the walls of working and living environments with grazing light. It disappears into the false ceiling, easy to install and designed with the best optical systems to guarantee perfect lighting of spaces. It is proposed in two versions: with recessed diffuser for a “luminous throat” effect and with external diffuser for visual continuity.

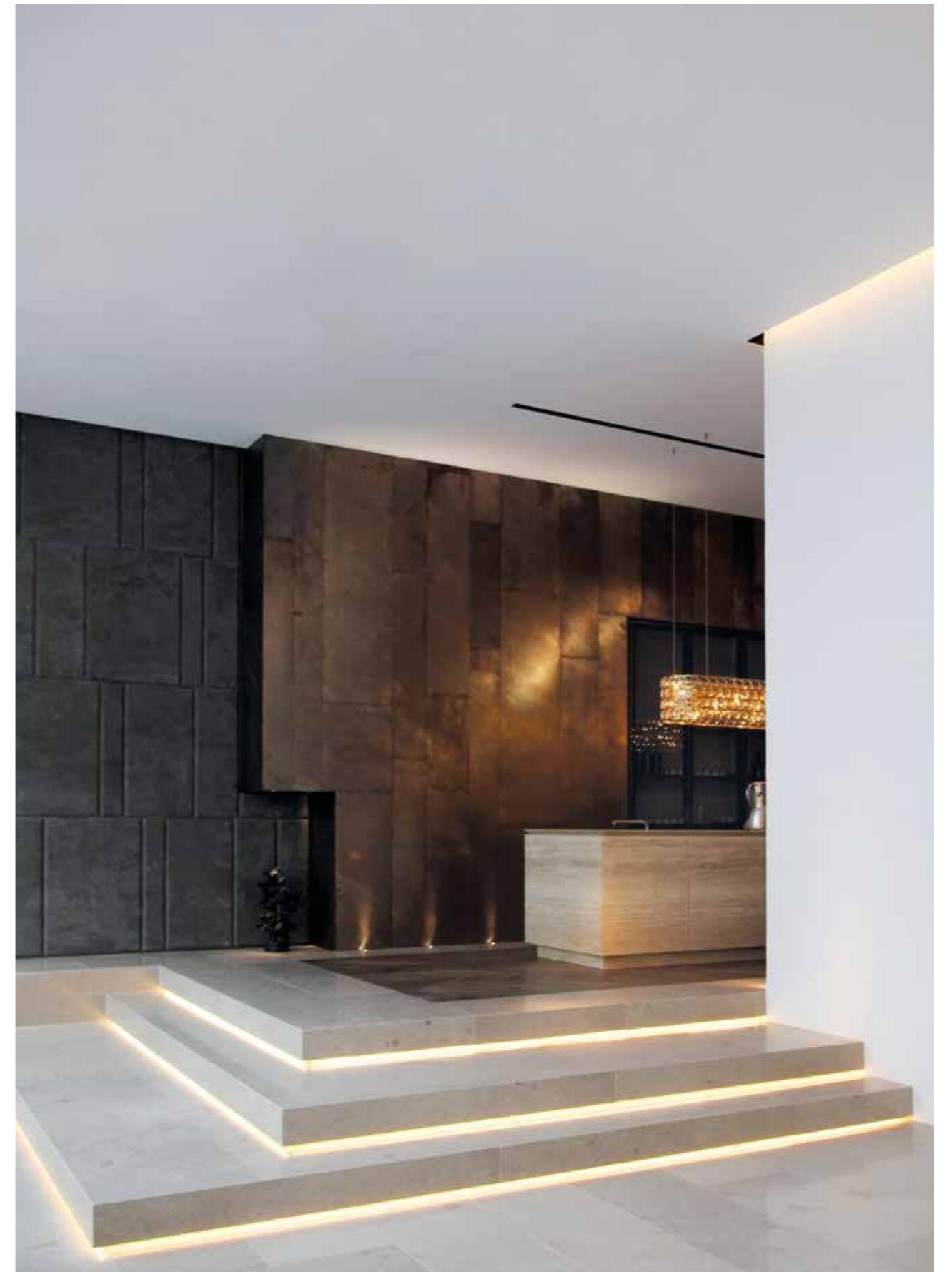

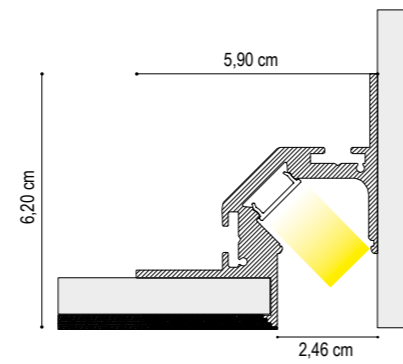

KEPLER CON COVER RECESSA
KEPLER WITH RECESSED COVER

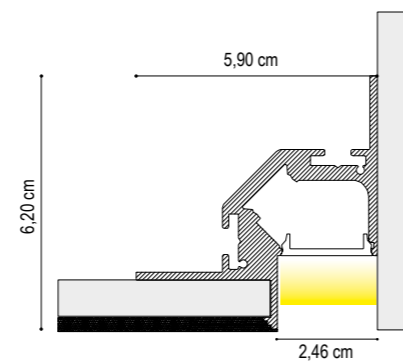

KEPLER CON COVER ESTERNA
KEPLER WITH EXTERNAL COVER

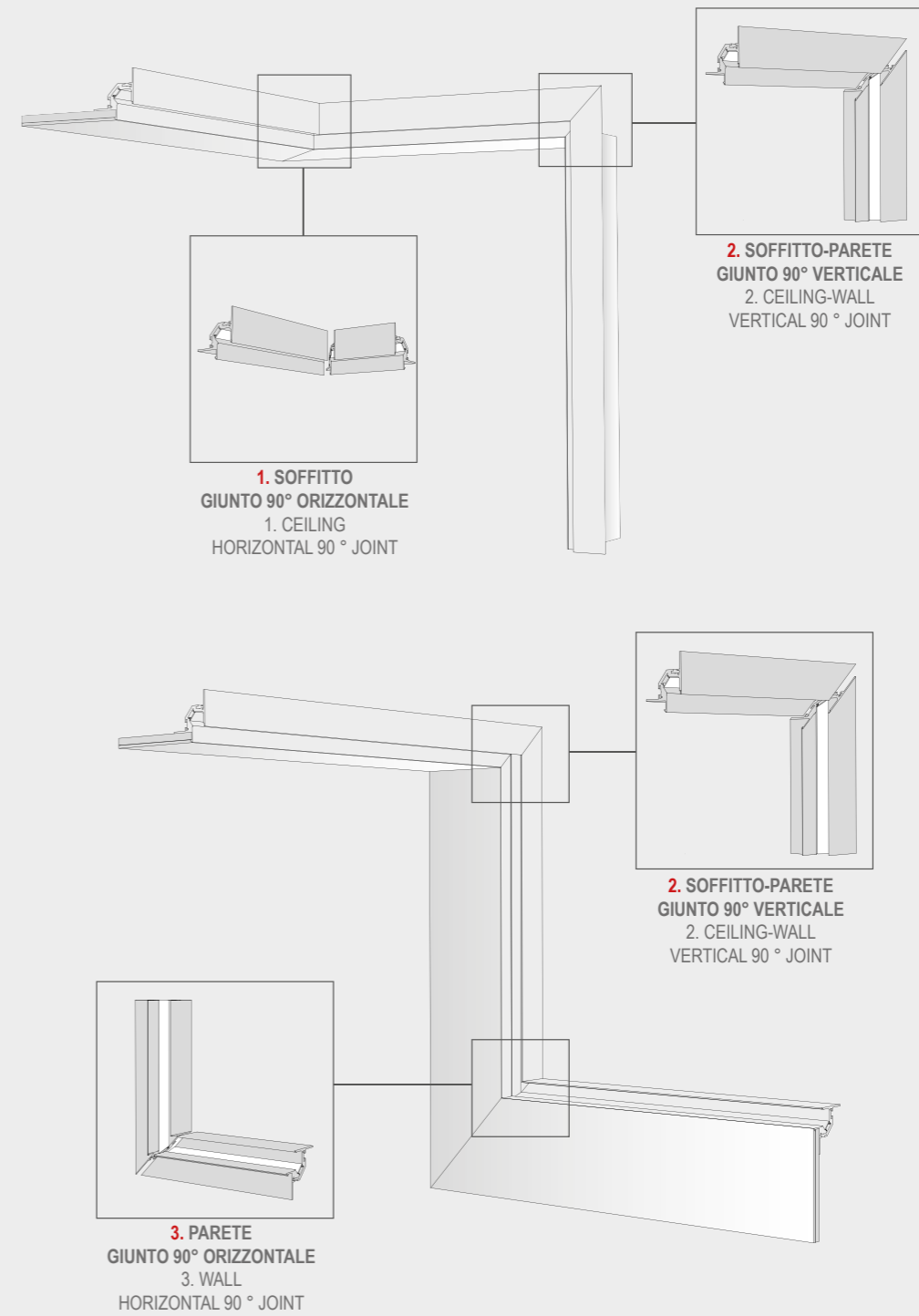
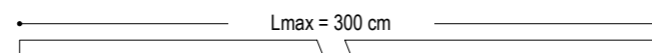

	ACCESSORI RICHIESTI ACCESSORIES REQUIRED	CODICE CODE	LAVORAZIONI PROCESSING
1. SOFFITTO 1. CEILING	N°1 GIUNTO MECCANICO N° 1 MECHANICAL JOINT	210500	TAGLIO ANGOLARE - CODICE 190X CORNER CUT - CODE 190X
2. SOFFITTO-PARETE 2. CEILING-WALL	N°1 GIUNTO MECCANICO N° 1 MECHANICAL JOINT	IL GIUNTO PUÒ ESSERE UTILIZZATO PER COMPORRE ANGOLI ORIZZONTALI E VERTICALI THE JOINT CAN BE USED TO COMBINE HORIZONTAL AND VERTICAL CORNERS.	TAGLIO ANGOLARE - CODICE 190Y CORNER CUT - CODE 190Y
3. PARETE 3. WALL	N°1 GIUNTO MECCANICO N° 1 MECHANICAL JOINT		TAGLIO ANGOLARE - CODICE 190X CORNER CUT - CODE 190X

kepler

led integrato

integrated led



DRIVER NON INCLUSO / NOT INCLUDED

LUNGHEZZA CAVO ALIMENTAZIONE: 50 cm
ALIMENTATION CABLE LENGTH: 50 cm

ATTENZIONE! IL PROFILO E' STATO DIMENSIONATO PER UN PANNELLO STANDARD IN CARTONGESSO DI SPESSORE 12,5 mm

WARNING! THE PROFILE HAS BEEN SIZED FOR A STANDARD PLASTERBOARD PANEL OF 12.5 mm THICKNESS

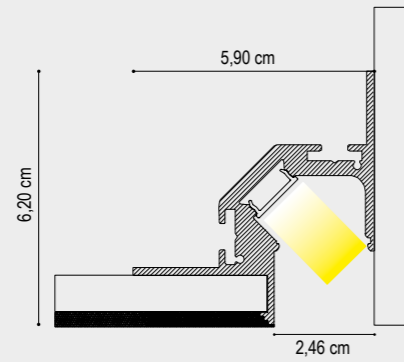

DATI TECNICI
TECHNICAL DATA

COVER RECESSA / RECESSED DIFFUSER

20W/m

1 cm

LED Flux: 2200 lm/m
Flux Tot: 1760 lm/m
Output: 105 lm/W
CCT: 3000 K
CRI: >90
Power Tot: 20.0W/m
Weight: 0.90 Kg/m

Profilo/Profile: Alluminio/aluminum
Cover: Opale/opal

1 cm

1 cm

1 cm

FINITURA STRUTTURA
FINISHES

BIANCO INTONACO/WHITE

NERO CARAVAGGIO/BLACK

ALLUMINIO NATURALE/ALUMINUM

ORO CALIFORNIA/GOLD

DIFFUSORE
DIFFUSER

OPALE/OPAL

CODICE 2700K
CODE 2700K

2146030001

2146040001

2146060001

2146090001

CODICE 3000K
CODE 3000K

2147030001

2147040001

2147060001

2147090001

CODICE 4000K
CODE 4000K

2148030001

2148040001

2148060001

2148090001

NEL CODICE PROFILO È INCLUSA LA COVER POSA IN OPERA (COVER MONOUSO PER PROTEGGERE IL PROFILO DURANTE LE FASI DI INSTALLAZIONE)

THE COVER INSTALLED IS INCLUDED IN THE PROFILE CODE (DISPOSABLE COVER TO PROTECT THE PROFILE DURING THE INSTALLATION PHASES)

kepler

led integrato

integrated led



DRIVER NON INCLUSO / NOT INCLUDED

LUNGHEZZA CAVO ALIMENTAZIONE: 50 cm
ALIMENTATION CABLE LENGTH: 50 cm

ATTENZIONE! IL PROFILO E' STATO DIMENSIONATO PER UN PANNELLO STANDARD IN CARTONGESSO DI SPESSORE 12,5 mm

WARNING! THE PROFILE HAS BEEN SIZED FOR A STANDARD PLASTERBOARD PANEL OF 12.5 mm THICKNESS

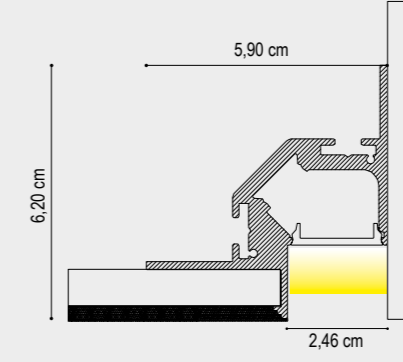

DATI TECNICI
TECHNICAL DATA

COVER ESTERNA / EXTERNAL DIFFUSER

20W/m

1 cm

LED Flux: 2200 lm/m
Flux Tot: 1760 lm/m
Output: 105 lm/W
CCT: 3000 K
CRI: >90
Power Tot: 20.0W/m
Weight: 0.90 Kg/m

Profilo/Profile: Alluminio/aluminum
Cover: Opale/opal

1 cm

1 cm

1 cm

FINITURA STRUTTURA
FINISHES

BIANCO INTONACO/WHITE

NERO CARAVAGGIO/BLACK

ALLUMINIO NATURALE/ALUMINUM

ORO CALIFORNIA/GOLD

DIFFUSORE
DIFFUSER

OPALE/OPAL

CODICE 2700K
CODE 2700K

2146030011

2146040011

2146060011

2146090011

CODICE 3000K
CODE 3000K

2147030011

2147040011

2147060011

2147090011

CODICE 4000K
CODE 4000K

2148030011

2148040011

2148060011

2148090011

NEL CODICE PROFILO È INCLUSA LA COVER POSA IN OPERA (COVER MONOUSO PER PROTEGGERE IL PROFILO DURANTE LE FASI DI INSTALLAZIONE)

THE COVER INSTALLED IS INCLUDED IN THE PROFILE CODE (DISPOSABLE COVER TO PROTECT THE PROFILE DURING THE INSTALLATION PHASES)

kepler

profilo e cover recessa

profile and recessed diffuser



ATTENZIONE! IL PROFILO E' STATO DIMENSIONATO PER UN PANNELLO STANDARD IN CARTONGESSO DI SPESSORE 12,5 mm

WARNING! THE PROFILE HAS BEEN SIZED FOR A STANDARD PLASTERBOARD PANEL OF 12.5 mm THICKNESS

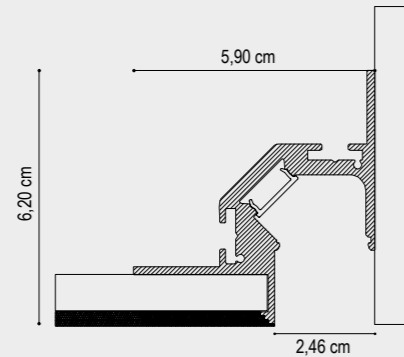

Profilo/profile: Alluminio / aluminum
Cover: Opale / opal

1 cm

200 cm

300 cm

FINITURA STRUTTURA
FINISHES

BIANCO INTONACO/WHITE

NERO CARAVAGGIO/BLACK

ALLUMINIO NATURALE/ALUMINUM

ORO CALIFORNIA/GOLD

DIFFUSORE
DIFFUSER

OPALE/OPAL

CODICE
CODE

2103031001

2103041001

2103061001

2103091001

CODICE
CODE

2103031200

2103041200

2103061200

2103091200

CODICE
CODE

2103031300

2103041300

2103061300

2103091300



kepler

profilo e cover esterna

profile and external diffuser



ATTENZIONE! IL PROFILO E' STATO DIMENSIONATO PER UN PANNELLO STANDARD IN CARTONGESSO DI SPESSORE 12,5 mm

WARNING! THE PROFILE HAS BEEN SIZED FOR A STANDARD PLASTERBOARD PANEL OF 12.5 mm THICKNESS

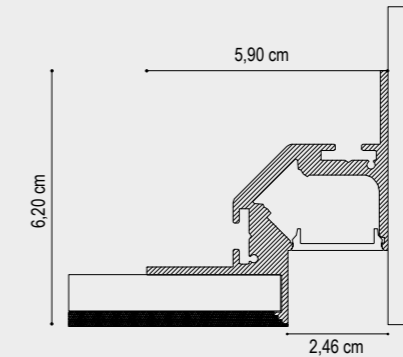

Profilo/profile: Alluminio / aluminum
Cover: Opale / opal

1 cm

200 cm

300 cm

FINITURA STRUTTURA
FINISHES

BIANCO INTONACO/WHITE

NERO CARAVAGGIO/BLACK

ALLUMINIO NATURALE/ALUMINUM

ORO CALIFORNIA/GOLD

DIFFUSORE
DIFFUSER

OPALE/OPAL

CODICE
CODE

2103033001

2103043001

2103063001

2103093001

CODICE
CODE

2103033200

2103043200

2103063200

2103093200

CODICE
CODE

2103033300

2103043300

2103063300

2103093300

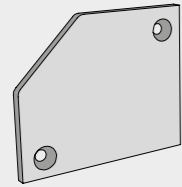

TESTATE DI CHIUSURA / DEAD ENDS

FINITURA STRUTTURA
 FINISHES

BIANCO INTONACO/WHITE
NERO CARAVAGGIO/BLACK
ALLUMINIO NATURALE/ALUMINUM
ORO CALIFORNIA/GOLD

CODICE
 CODE

210403
210404
210406
210409

Nel codice sono comprese le viti per il fissaggio delle testate al profilo. Il codice contiene n° 1 testate di chiusura.
 The code includes the screws for fixing the heads to the profile. The code contains 1 closing warheads

GIUNTI / JOINTS

GIUNTO LINEA CONTINUA / STRAIGHT JOINT

Accessorio per giunzioni meccaniche lineari
 Accessory for linear mechanical joints

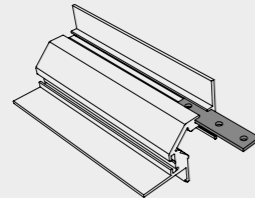
FINITURA
 FINISHES

CODICE
 CODE

ALLUMINIO NATURALE/ALUMINUM

210501

GIUNTO 90° ORIZZONTALE / HORIZONTAL JOINT
90°

Accessorio per giunzioni meccaniche con angolo
 90°
 Accessory for linear mechanical joints with 90° angle

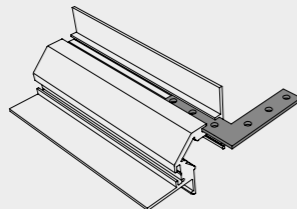
ALLUMINIO NATURALE/ALUMINUM

210500

Nel codice sono compresi i grani per il fissaggio del giunto/The code includes the grains for fixing the joint.
 Il codice contiene n°1 giunto/The code includes n°1 joint

LAVORAZIONI / PROCESSING

DATI TECNICI
 TECHNICAL DATA

CODICE
 CODE

TAGLIO 90° ORIZZONTALE (PER ANGOLI FORMATI DA DUE PROFILI)
 HORIZONTAL 90 ° CUT (FOR CORNERS MADE OF TWO PROFILES)

190X

TAGLIO 90° VERTICALE (PER ANGOLI FORMATI DA DUE PROFILI)
 VERTICAL 90 ° CUT (FOR CORNERS MADE OF TWO PROFILES)

190Y

ASOLA / SLOT

100A

FORO / HOLE

100F

CABLAGGIO - COLLAUDO - CE AL CENTIMETRO
 INSTALLATION AND TESTING LED MODULE AT CENTIMETER

2801

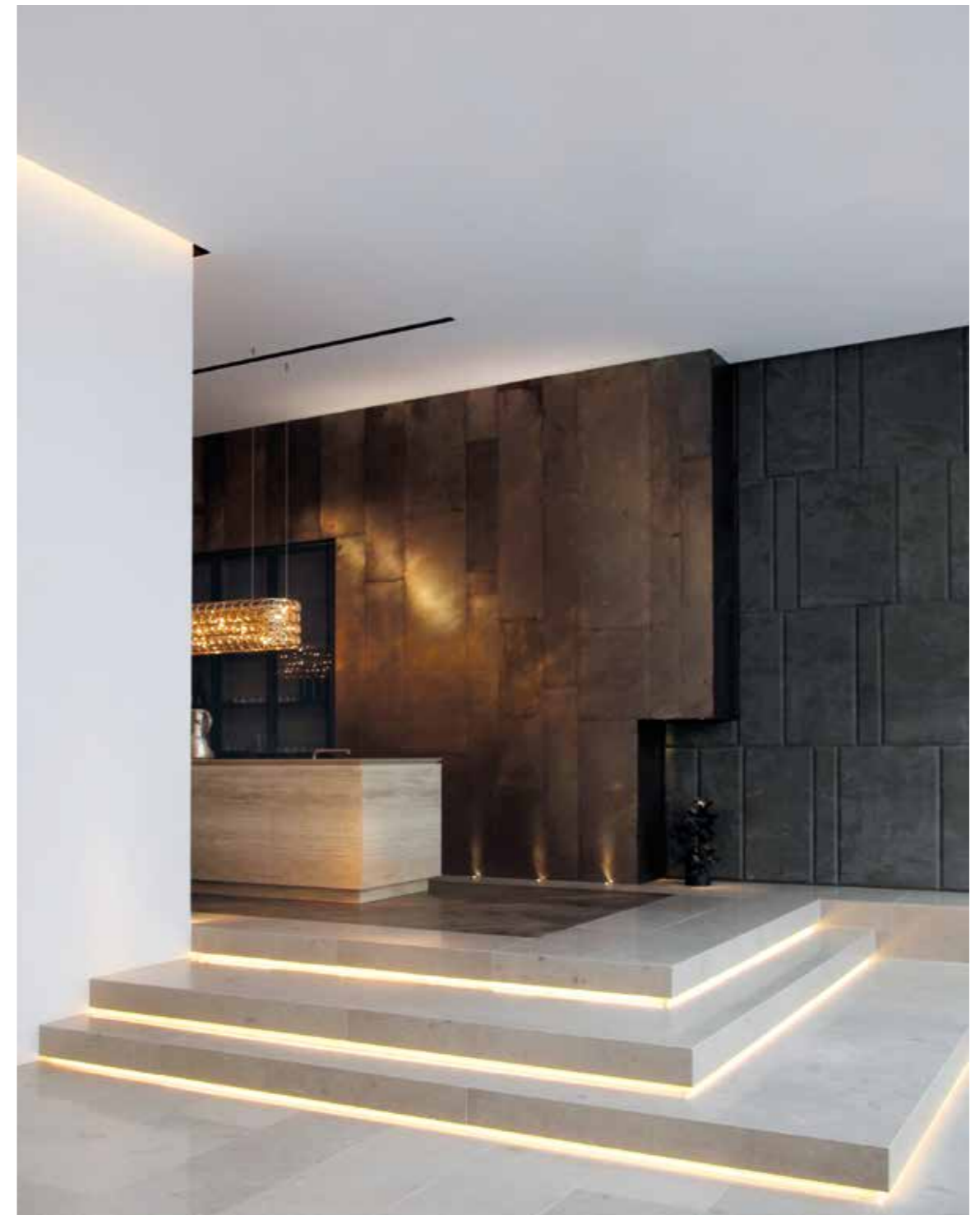

zero55	364	hydria tondo	710
zero75	380	flama quadra	710
zero35	402	flama tondo	710
zero35 – p	414		
zero35 spot advanced	422		
zero35 x	426		
zero35 xp	436		
zero35 t + zero35 m	446		
zero65 + zero65 x	458		
zero65 p	468		
zero65 spot advanced	480		
zero66	484		
q10	492		
q20	500		
structurae	510		
k40	522		
k25	530		
k15	538		
s21	546		
ch012	554		
lc020	566		
lc014	576		
lc021	592		
sc015	600		
ms07	608		
ms08	616		
ms09	624		
ut01 + ut02	636		
u01	642		
u02 + u02 spot	658		
u03	680		
mira	692		
mc01 + mc02	698		
mf01	704		
mf02	778		
quadra	706		
faretti			
hydria quadro	710		

**“tecnologia al top
per qualità, resa cromatica,
lumen emessi, temperatura colore”**

ZER055 costruito in estruso di alluminio si avvale della tecnologia degli schermi in policarbonato per diffondere la luce per mezzo di LED al top, per qualità, resa cromatica, lumen emessi, ed accurata selezione della temperatura colore, scelta in base al progetto scenografico che vogliamo ottenere. ZER035 offre una gamma di finiture e di accessori, i tagli lineari e a 45° o su MISURA, rendono realizzabile qualsiasi progetto sia esso da incasso a parete, plafone o sospensione.

ZER055 is made in extruded aluminium. Use polycarbonate technology for diffusing led light with high precision, use high quality like led, colour rendering, lumen output and accurate colour temperature for ensuring optimal results for each type of project. ZER035 offers a wide gamma of finishing's and accessories, several lengths, 45°cuts or completely customized. With Zer035 it's possible to realize any kind of projects like wall-recessed, surface mounting or pendant. Epedio comnist

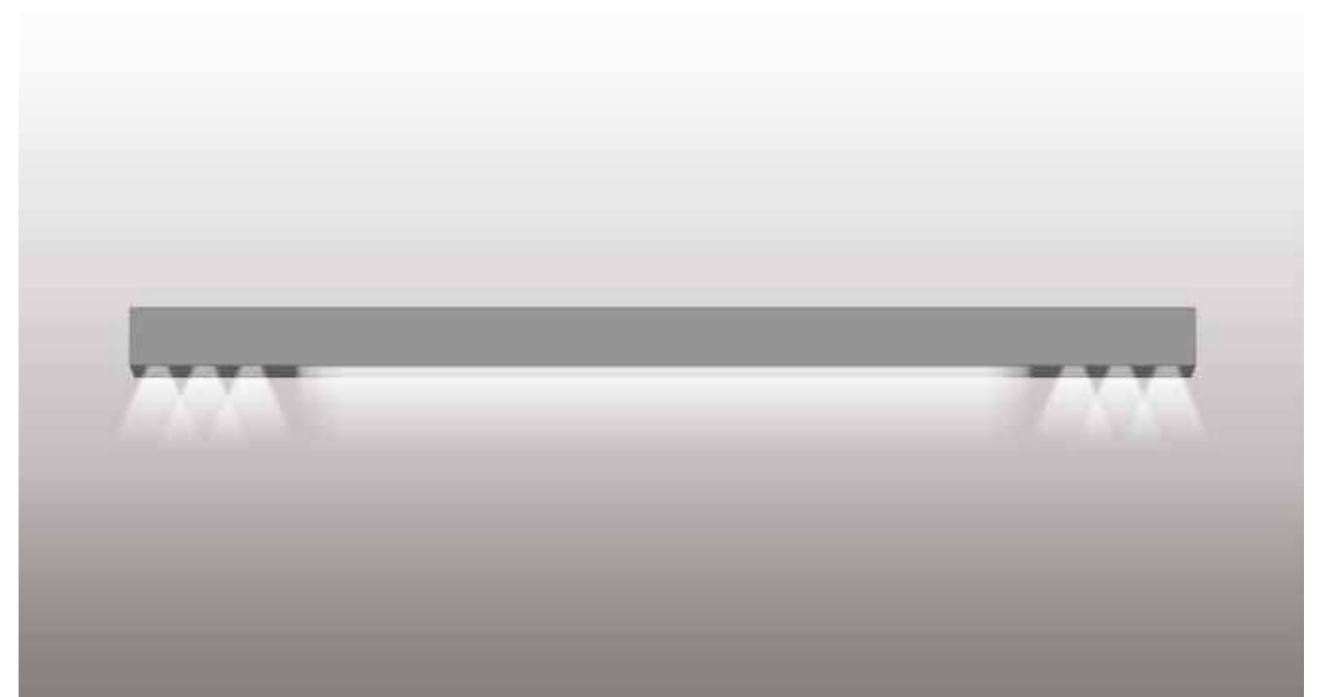
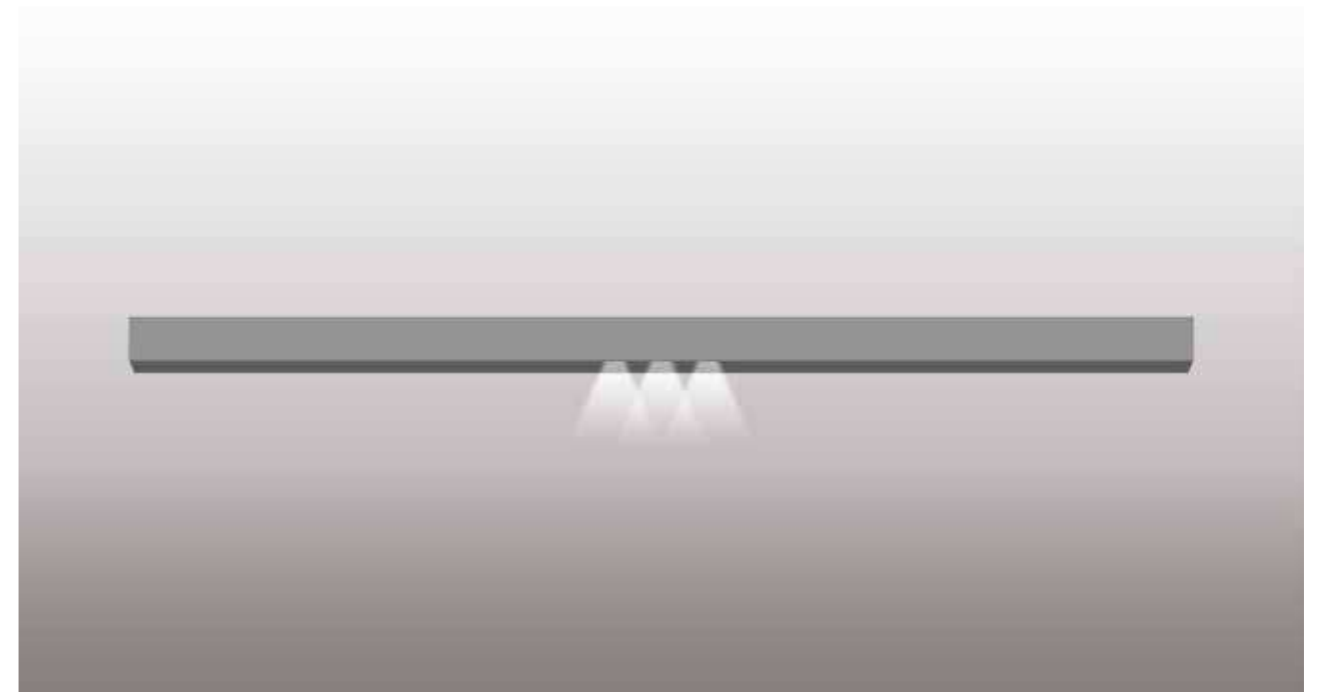

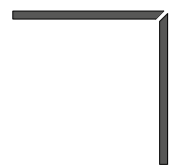

A. COMPOSIZIONE ANGOLARE A "L"
A. L-ANGLE COMPOSITION

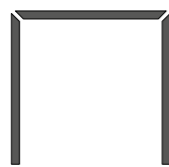

B. COMPOSIZIONE ANGOLARE A "C"
B. C-ANGLE COMPOSITION

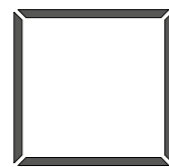

C. COMPOSIZIONE POLIGONALE (QUADRATO/RETTANGOLO)
C. POLYGONAL COMPOSITION (SQUARE / RECTANGLE)



D. COMPOSIZIONE POLIGONALE (PENTAGONO/ESAGONO)
D. POLYGONAL COMPOSITION (PENTAGON / HEX)

INSTALLAZIONE A SOSPENSIONE
SUSPENSION

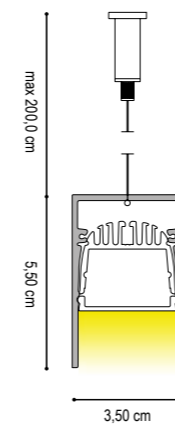

INSTALLAZIONE A SOFFITTO
CEILING INSTALLATION

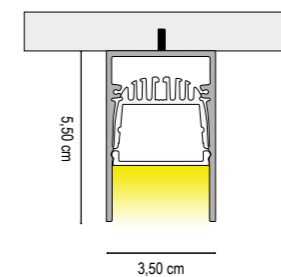

INSTALLAZIONE A INCASSO IN CARTONGESSO
RECESSED INSTALLATION IN PLASTERBOARD

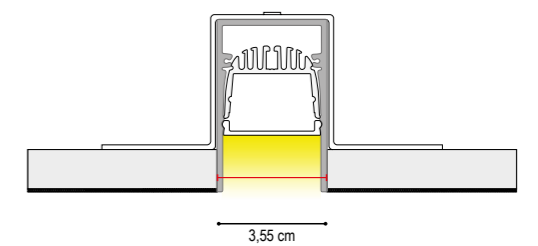

INSTALLAZIONE AD INCASSO
LARGHEZZA TAGLIO L=3,55cm
RECESSED INSTALLATION
CUTTING WIDTH L=3,50 cm

ATTENZIONE! GLI ACCESSORI PER L'INSTALLAZIONE A INCASSO SONO STATI DIMENSIONATI PER UN PANNELLO STANDARD IN CARTONGESSO DI SPESSORE 12,5 mm
WARNING! THE BUILT-IN INSTALLATION ACCESSORIES HAVE BEEN DIMENSIONED FOR A STANDARD PLASTERBOARD PANEL OF 12.5 mm THICKNESS

ESEMPIO 1 / TYPE 1

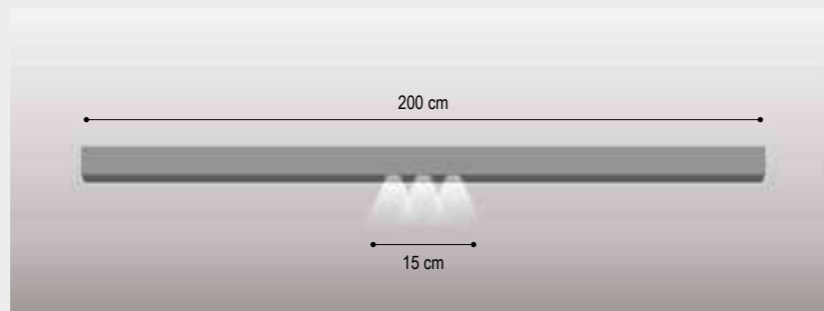

VISTA FRONTALE / FRONT VIEW

ESEMPIO 4 / TYPE 4

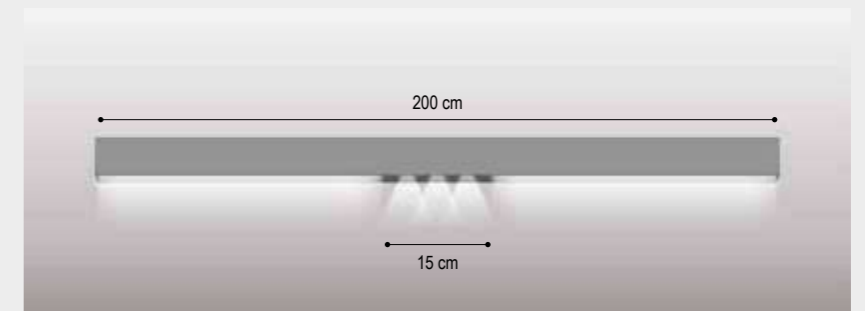

VISTA FRONTALE / FRONT VIEW

ESEMPIO 2 / TYPE 2



VISTA LATERALE / SIDE VIEW

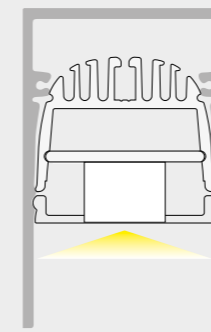

VISTA LATERALE / SIDE VIEW

ESEMPIO 5 / TYPE 5



VISTA LATERALE / SIDE VIEW

ESEMPIO 3 / TYPE 3

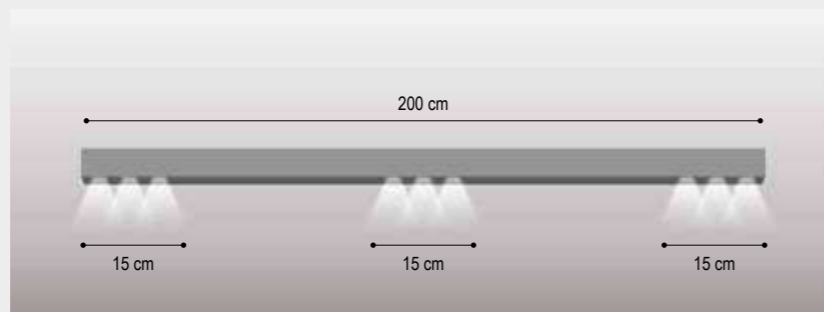

VISTA FRONTALE / FRONT VIEW

ESEMPIO 6 / TYPE 6

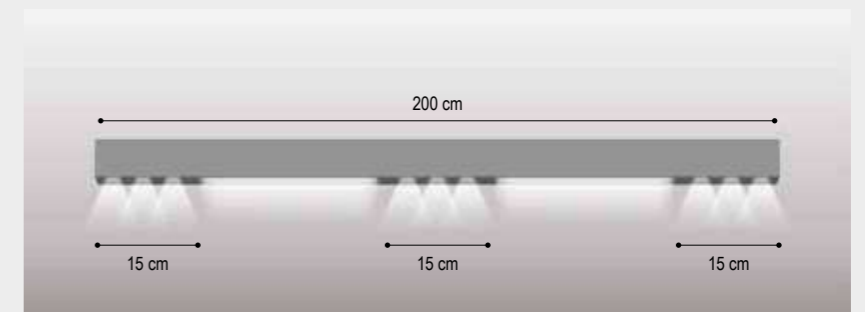

VISTA FRONTALE / FRONT VIEW

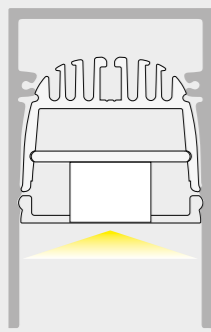

VISTA LATERALE / SIDE VIEW

zero55

led integrato

integrated led

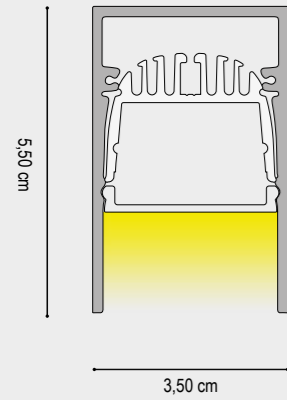

DATI TECNICI
TECHNICAL DATA

	1 cm - 2700K	1 cm - 3000K	1 cm - 4000K
Nominal LED Flux:	2100 lm/m	2200 lm/m	2350 lm/m
Flux Tot:	1680 lm/m	1760 lm/m	1880 lm/m
Output:	105 lm/W	110 lm/W	117 lm/W
CCT:	2700 K	3000 K	4000 K
CRI:	>90	>90	>90
Power Tot:	20.0 W/m	20.0 W/m	20.0 W/m
Weight:	0.90 Kg/m	0.90 Kg/m	0.90 Kg/m

Profilo/Profile: Alluminio/aluminum

Cover: Opale/opal

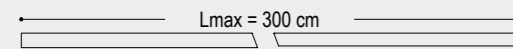

DRIVER NON INCLUSO / NOT INCLUDED

CAVO ALIMENTAZIONE: 50 cm
ALIMENTATION CABLE: 50 cm

zero55 — ugr<19

led integrato

integrated led

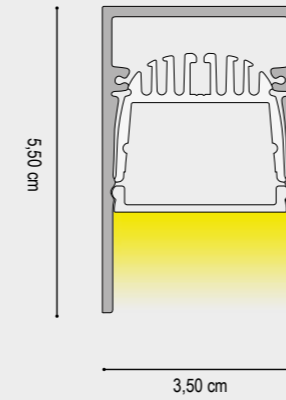

DATI TECNICI
TECHNICAL DATA

	1 cm - 2700K	1 cm - 3000K	1 cm - 4000K
Nominal LED Flux:	2100 lm/m	2200 lm/m	2350 lm/m
Flux Tot:	1890 lm/m	1980 lm/m	2115 lm/m
Output:	105 lm/W	110 lm/W	117 lm/W
CCT:	2700 K	3000 K	4000 K
CRI:	>90	>90	>90
Power Tot:	20.0 W/m	20.0 W/m	20.0 W/m
Weight:	0.90 Kg/m	0.90 Kg/m	0.90 Kg/m

Profilo/Profile: Alluminio/aluminum

Cover: Prismaticata/
Prismatic

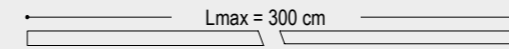

DRIVER NON INCLUSO / NOT INCLUDED

CAVO ALIMENTAZIONE: 50 cm
ALIMENTATION CABLE: 50 cm

FINITURA STRUTTURA FINISHES	DIFFUSORE DIFFUSER	1 cm - 2700K	1 cm - 3000K	1 cm - 4000K
		CODICE CODE	CODICE CODE	CODICE CODE
GRIGIO VESUVIO ANTHRACITE	OPALE/OPAL	5546000001	5547000001	5548000001
ARGILLA CLAY		5546010001	5547010001	5548010001
ARGENTO OPACO/MATT SILVER		5546020001	5547020001	5548020001
BIANCO INTONACO/WHITE		5546030001	5547030001	5548030001
NERO CARAVAGGIO/BLACK		5546040001	5547040001	5548040001
MOKA MOCHA		5546050001	5547050001	5548050001
CROMO/CHROME		5546080001	5547080001	5548080001
ORO CALIFORNIA/GOLD		5546090001	5547090001	5548090001
ARAMEN COPPER		5546100001	5547100001	5548100001
GRIGIO AVIO/GREY AVIO		5546110001	5547110001	5548110001
ARGENTO COMETA/SILVER COMET		5546120001	5547120001	5548120001
OTTONE VENEZIANO/BRASS		5546130001	5547130001	5548130001
TITANIO/TITANIUM		5546140001	5547140001	5548140001
BRONZO RIACI/RIACI BRONZE		5546150001	5547150001	5548150001
VERDE COSTA/GREEN COAST		5546160001	5547160001	5548160001
TERRA SENESE SENESE EARTH		5546170001	5547170001	5548170001

N.B./P.N.:

LUNGHEZZA MASSIMA VERSIONE CROMO = 2,00 m / MAXIMUM LENGTH CHROME VERSION = 2.00 m
TESTATE NON INCLUSE / DEAD ENDS NOT INCLUDED

FINITURA STRUTTURA FINISHES	DIFFUSORE DIFFUSER	1 cm - 2700K	1 cm - 3000K	1 cm - 4000K
		CODICE CODE	CODICE CODE	CODICE CODE
GRIGIO VESUVIO ANTHRACITE	PRISMATIZZATO PRISMATIC	5546003001	5547003001	5548003001
ARGILLA CLAY		5546013001	5547013001	5548013001
ARGENTO OPACO/MATT SILVER		5546023001	5547023001	5548023001
BIANCO INTONACO/WHITE		5546033001	5547033001	5548033001
NERO CARAVAGGIO/BLACK		5546043001	5547043001	5548043001
MOKA MOCHA		5546053001	5547053001	5548053001
CROMO/CHROME		5546083001	5547083001	5548083001
ORO CALIFORNIA/GOLD		5546093001	5547093001	5548093001
ARAMEN COPPER		5546103001	5547103001	5548103001
GRIGIO AVIO/GREY AVIO		5546113001	5547113001	5548113001
ARGENTO COMETA/SILVER COMET		5546123001	5547123001	5548123001
OTTONE VENEZIANO/BRASS		5546133001	5547133001	5548133001
TITANIO/TITANIUM		5546143001	5547143001	5548143001
BRONZO RIACI/RIACI BRONZE		5546153001	5547153001	5548153001
VERDE COSTA/GREEN COAST		5546163001	5547163001	5548163001
TERRA SENESE SENESE EARTH		5546173001	5547173001	5548173001

N.B./P.N.:

LUNGHEZZA MASSIMA VERSIONE CROMO = 2,00 m / MAXIMUM LENGTH CHROME VERSION = 2.00 m
TESTATE NON INCLUSE / DEAD ENDS NOT INCLUDED



zero55

led integrato

integrated led

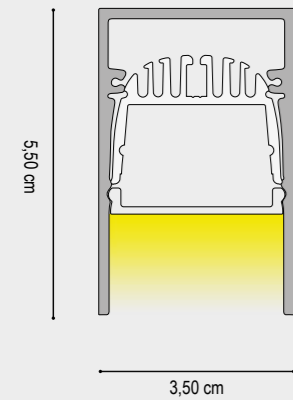

DATI TECNICI
TECHNICAL DATA

	1 cm - 2700K	1 cm - 3000K	1 cm - 4000K
Nominal LED Flux:	2916 lm/m	3024 lm/m	3125 lm/m
Flux Tot:	2333 lm/m	2419 lm/m	2500 lm/m
Output:	135 lm/W	140 lm/W	145 lm/W
CCT:	2700 K	3000 K	4000 K
CRI:	>90	>90	>90
Power Tot:	22 W/m	22 W/m	22 W/m
Weight:	0.90 Kg/m	0.90 Kg	0.90 Kg

Profilo/Profile: Alluminio/aluminum

Cover: Opale/opal

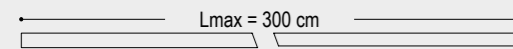

DRIVER NON INCLUSO / NOT INCLUDED

CAVO ALIMENTAZIONE: 50 cm
ALIMENTATION CABLE: 50 cm

zero55 — ugr<19

led integrato

integrated led

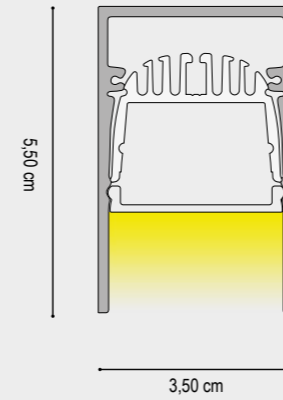

DATI TECNICI
TECHNICAL DATA

	1 cm - 2700K	1 cm - 3000K	1 cm - 4000K
Nominal LED Flux:	2916 lm/m	3024 lm/m	3125 lm/m
Flux Tot:	2624 lm/m	2722 lm/m	2812 lm/m
Output:	135 lm/W	140 lm/W	145 lm/W
CCT:	2700 K	3000 K	4000 K
CRI:	>90	>90	>90
Power Tot:	22 W/m	22 W/m	22 W/m
Weight:	0.90 Kg/m	0.90 Kg	0.90 Kg

Profilo/Profile: Alluminio/aluminum

Cover: Prismaticata/
Prismatic

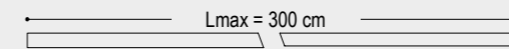

DRIVER NON INCLUSO / NOT INCLUDED

CAVO ALIMENTAZIONE: 50 cm
ALIMENTATION CABLE: 50 cm

FINITURA STRUTTURA
FINISHES

- GRIGIO VESUVIO ANTHRACITE
- ARGILLA CLAY
- ARGENTO OPACO/MATT SILVER
- BIANCO INTONACO/WHITE
- NERO CARAVAGGIO BLACK
- MOKA MOCHA
- CROMO/CHROME
- ORO CALIFORNIA/GOLD
- ARAMEN COPPER
- GRIGIO AVIO GREY AVIO
- ARGENTO COMETA/SILVER COMET
- OTTONE VENEZIANO BRASS
- TITANIO/TITANIUM
- BRONZO RIACI/RIACI BRONZE
- VERDE COSTA/GREEN COAST
- TERRA SENESE SENESE EARTH

DIFFUSORE
DIFFUSER

OPALE/OPAL

	1 cm - 2700K	1 cm - 3000K	1 cm - 4000K
CODICE CODE	CODICE CODE	CODICE CODE	CODICE CODE
5586000001	5587000001	5588000001	
5586010001	5587010001	5588010001	
5586020001	5587020001	5588020001	
5586030001	5587030001	5588030001	
5586040001	5587040001	5588040001	
5586050001	5587050001	5588050001	
5586080001	5587080001	5588080001	
5586090001	5587090001	5588090001	
5586100001	5587100001	5588100001	
5586110001	5587110001	5588110001	
5586120001	5587120001	5588120001	
5586130001	5587130001	5588130001	
5586140001	5587140001	5588140001	
5586150001	5587150001	5588150001	
5586160001	5587160001	5588160001	
5586170001	5587170001	5588170001	

N.B./P.N.:
LUNGHEZZA MASSIMA VERSIONE CROMO = 2,00 m / MAXIMUM LENGTH CHROME VERSION = 2.00 m
TESTATE NON INCLUSE / DEAD ENDS NOT INCLUDED

FINITURA STRUTTURA
FINISHES

- GRIGIO VESUVIO ANTHRACITE
- ARGILLA CLAY
- ARGENTO OPACO/MATT SILVER
- BIANCO INTONACO/WHITE
- NERO CARAVAGGIO BLACK
- MOKA MOCHA
- CROMO/CHROME
- ORO CALIFORNIA/GOLD
- ARAMEN COPPER
- GRIGIO AVIO GREY AVIO
- ARGENTO COMETA/SILVER COMET
- OTTONE VENEZIANO BRASS
- TITANIO/TITANIUM
- BRONZO RIACI/RIACI BRONZE
- VERDE COSTA/GREEN COAST
- TERRA SENESE SENESE EARTH

DIFFUSORE
DIFFUSER

PRISMATIZZATO
PRISMATIC

	1 cm - 2700K	1 cm - 3000K	1 cm - 4000K
CODICE CODE	CODICE CODE	CODICE CODE	CODICE CODE
5586003001	5587003001	5588003001	
5586013001	5587013001	5588013001	
5586023001	5587023001	5588023001	
5586033001	5587033001	5588033001	
5586043001	5587043001	5588043001	
5586053001	5587053001	5588053001	
5586083001	5587083001	5588083001	
5586093001	5587093001	5588093001	
5586103001	5587103001	5588103001	
5586113001	5587113001	5588113001	
5586123001	5587123001	5588123001	
5586133001	5587133001	5588133001	
5586143001	5587143001	5588143001	
5586153001	5587153001	5588153001	
5586163001	5587163001	5588163001	
5586173001	5587173001	5588173001	

N.B./P.N.:
LUNGHEZZA MASSIMA VERSIONE CROMO = 2,00 m / MAXIMUM LENGTH CHROME VERSION = 2.00 m
TESTATE NON INCLUSE / DEAD ENDS NOT INCLUDED



zero55

led integrato

integrated led

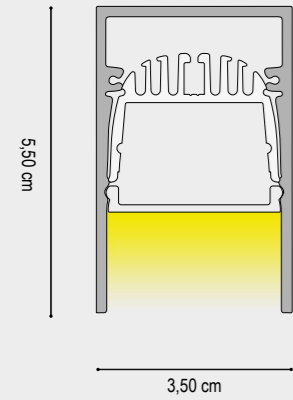

DATI TECNICI
TECHNICAL DATA

	1 cm - 2700K	1 cm - 3000K	1 cm - 4000K
Nominal LED Flux:	3680 lm/m	4000 lm/m	4160 lm/m
Flux Tot:	2944 lm/m	3200 lm/m	3328 lm/m
Output:	115 lm/W	125 lm/W	130 lm/W
CCT:	2700 K	3000 K	4000 K
CRI:	>90	>90	>90
Power Tot:	32.0 W/m	32.0 W/m	32.0 W/m
Weight:	0.90 Kg/m	0.90 Kg/m	0.90 Kg/m

Profilo/Profile: Alluminio/aluminum

Cover: Opale/opal

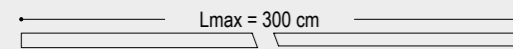

DRIVER NON INCLUSO / NOT INCLUDED

CAVO ALIMENTAZIONE: 50 cm
ALIMENTATION CABLE: 50 cm

zero55 — ugr<19

led integrato

integrated led

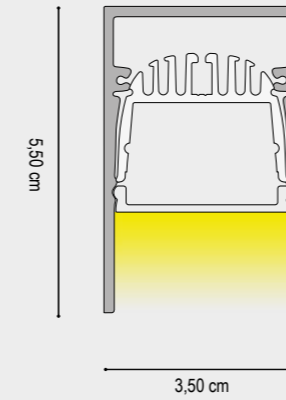

DATI TECNICI
TECHNICAL DATA

	1 cm - 2700K	1 cm - 3000K	1 cm - 4000K
Nominal LED Flux:	3680 lm/m	4000 lm/m	4160 lm/m
Flux Tot:	2944 lm/m	3200 lm/m	3328 lm/m
Output:	115 lm/W	125 lm/W	130 lm/W
CCT:	2700 K	3000 K	4000 K
CRI:	>90	>90	>90
Power Tot:	32.0 W/m	32.0 W/m	32.0 W/m
Weight:	0.90 Kg/m	0.90 Kg/m	0.90 Kg/m

Profilo/Profile: Alluminio/aluminum

Cover: Prismaticata/
Prismatic

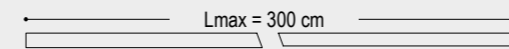

DRIVER NON INCLUSO / NOT INCLUDED

CAVO ALIMENTAZIONE: 50 cm
ALIMENTATION CABLE: 50 cm

FINITURA STRUTTURA
FINISHES

- GRIGIO VESUVIO ANTHRACITE
- ARGILLA CLAY
- ARGENTO OPACO/MATT SILVER
- BIANCO INTONACO/WHITE
- NERO CARAVAGGIO/BLACK
- MOKA MOCHA
- CROMO/CHROME
- ORO CALIFORNIA/GOLD
- ARAMEN COPPER
- GRIGIO AVIO/GREY AVIO
- ARGENTO COMETA/SILVER COMET
- OTTONE VENEZIANO/BRASS
- TITANIO/TITANIUM
- BRONZO RIACI/RIACI BRONZE
- VERDE COSTA/GREEN COAST
- TERRA SENESE SENESE EARTH

DIFFUSORE
DIFFUSER

OPALE/OPAL

	1 cm - 2700K	1 cm - 3000K	1 cm - 4000K
CODICE CODE	55J2000001	55J3000001	55J4000001
55J2010001	55J3010001	55J4010001	
55J2020001	55J3020001	55J4020001	
55J2030001	55J3030001	55J4030001	
55J2040001	55J3040001	55J4040001	
55J2050001	55J3050001	55J4050001	
55J2080001	55J3080001	55J4080001	
55J2090001	55J3090001	55J4090001	
55J2100001	55J3100001	55J4100001	
55J2110001	55J3110001	55J4110001	
55J2120001	55J3120001	55J4120001	
55J2130001	55J3130001	55J4130001	
55J2140001	55J3140001	55J4140001	
55J2150001	55J3150001	55J4150001	
55J2160001	55J3160001	55J4160001	
55J2170001	55J3170001	55J4170001	

N.B./P.N.:
LUNGHEZZA MASSIMA VERSIONE CROMO = 2,00 m / MAXIMUM LENGTH CHROME VERSION = 2.00 m
TESTATE NON INCLUSE / DEAD ENDS NOT INCLUDED

FINITURA STRUTTURA
FINISHES

- GRIGIO VESUVIO ANTHRACITE
- ARGILLA CLAY
- ARGENTO OPACO/MATT SILVER
- BIANCO INTONACO/WHITE
- NERO CARAVAGGIO/BLACK
- MOKA MOCHA
- CROMO/CHROME
- ORO CALIFORNIA/GOLD
- ARAMEN COPPER
- GRIGIO AVIO/GREY AVIO
- ARGENTO COMETA/SILVER COMET
- OTTONE VENEZIANO/BRASS
- TITANIO/TITANIUM
- BRONZO RIACI/RIACI BRONZE
- VERDE COSTA/GREEN COAST
- TERRA SENESE SENESE EARTH

DIFFUSORE
DIFFUSER

PRISMATIZZATO
PRISMATIC

	1 cm - 2700K	1 cm - 3000K	1 cm - 4000K
CODICE CODE	55J2003001	55J3003001	55J4003001
55J2013001	55J3013001	55J4013001	
55J2023001	55J3023001	55J4023001	
55J2033001	55J3033001	55J4033001	
55J2043001	55J3043001	55J4043001	
55J2053001	55J3053001	55J4053001	
55J2083001	55J3083001	55J4083001	
55J2093001	55J3093001	55J4093001	
55J2103001	55J3103001	55J4103001	
55J2113001	55J3113001	55J4113001	
55J2123001	55J3123001	55J4123001	
55J2133001	55J3133001	55J4133001	
55J2143001	55J3143001	55J4143001	
55J2153001	55J3153001	55J4153001	
55J2163001	55J3163001	55J4163001	
55J2173001	55J3173001	55J4173001	

N.B./P.N.:
LUNGHEZZA MASSIMA VERSIONE CROMO = 2,00 m / MAXIMUM LENGTH CHROME VERSION = 2.00 m
TESTATE NON INCLUSE / DEAD ENDS NOT INCLUDED



zero55

led integrato

integrated led

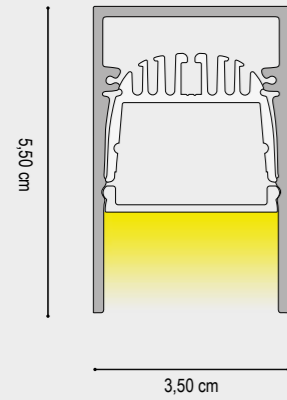

DATI TECNICI
TECHNICAL DATA

	1 cm - 2700K	1 cm - 3000K	1 cm - 4000K
Nominal LED Flux:	3900 lm/m	4050 lm/m	4200 lm/m
Flux Tot:	3000 lm/m	3120 lm/m	3240 lm/m
Output:	130 lm/W	135 lm/W	140 lm/W
CCT:	2700 K	3000 K	4000 K
CRI:	>90	>90	>90
Power Tot:	30.0 W/m	30.0 W/m	30.0 W/m
Weight:	0.90 Kg/m	0.90 Kg/m	0.90 Kg/m

Profilo/Profile: Alluminio/aluminum

Cover: Opale/opal

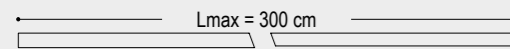

DRIVER NON INCLUSO / NOT INCLUDED

CAVO ALIMENTAZIONE: 50 cm
ALIMENTATION CABLE: 50 cm

zero55 — ugr<19

led integrato

integrated led

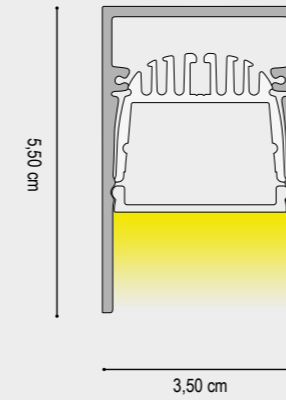

DATI TECNICI
TECHNICAL DATA

	1 cm - 2700K	1 cm - 3000K	1 cm - 4000K
Nominal LED Flux:	3900 lm/m	4050 lm/m	4200 lm/m
Flux Tot:	3375 lm/m	3510 lm/m	3645 lm/m
Output:	130 lm/W	135 lm/W	140 lm/W
CCT:	2700 K	3000 K	4000 K
CRI:	>90	>90	>90
Power Tot:	30.0 W/m	30.0 W/m	30.0 W/m
Weight:	0.90 Kg/m	0.90 Kg/m	0.90 Kg/m

Profilo/Profile: Alluminio/aluminum

Cover: Prismaticata/
Prismatic

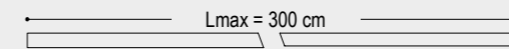

DRIVER NON INCLUSO / NOT INCLUDED

CAVO ALIMENTAZIONE: 50 cm
ALIMENTATION CABLE: 50 cm

FINITURA STRUTTURA FINISHES	DIFFUSORE DIFFUSER	1 cm - 2700K	1 cm - 3000K	1 cm - 4000K
		CODICE CODE	CODICE CODE	CODICE CODE
GRIGIO VESUVIO ANTHRACITE	OPALE/OPAL	558000001	558100001	558200001
ARGILLA CLAY		558001001	558101001	558201001
ARGENTO OPACO/MATT SILVER		558002001	558102001	558202001
BIANCO INTONACO/WHITE		558003001	558103001	558203001
NERO CARAVAGGIO/BLACK		558004001	558104001	558204001
MOKA MOCHA		558005001	558105001	558205001
CROMO/CHROME		558008001	558108001	558208001
ORO CALIFORNIA/GOLD		558009001	558109001	558209001
ARAMEN COPPER		558010001	558110001	558210001
GRIGIO AVIO/GREY AVIO		558011001	558111001	558211001
ARGENTO COMETA/SILVER COMET		558012001	558112001	558212001
OTTONE VENEZIANO/BRASS		558013001	558113001	558213001
TITANIO/TITANIUM		558014001	558114001	558214001
BRONZO RIACI/RIACI BRONZE		558015001	558115001	558215001
VERDE COSTA/GREEN COAST		558016001	558116001	558216001
TERRA SENESE/SENESE EARTH		558017001	558117001	558217001

N.B./P.N.:
LUNGHEZZA MASSIMA VERSIONE CROMO = 2,00 m / MAXIMUM LENGTH CHROME VERSION = 2.00 m
TESTATE NON INCLUSE / DEAD ENDS NOT INCLUDED

FINITURA STRUTTURA FINISHES	DIFFUSORE DIFFUSER	1 cm - 2700K	1 cm - 3000K	1 cm - 4000K
		CODICE CODE	CODICE CODE	CODICE CODE
GRIGIO VESUVIO ANTHRACITE	PRISMATIZZATO PRISMATIC	5580003001	5581003001	5582003001
ARGILLA CLAY		5580013001	5581013001	5582013001
ARGENTO OPACO/MATT SILVER		5580023001	5581023001	5582023001
BIANCO INTONACO/WHITE		5580033001	5581033001	5582033001
NERO CARAVAGGIO/BLACK		5580043001	5581043001	5582043001
MOKA MOCHA		5580053001	5581053001	5582053001
CROMO/CHROME		5580083001	5581083001	5582083001
ORO CALIFORNIA/GOLD		5580093001	5581093001	5582093001
ARAMEN COPPER		5580103001	5581103001	5582103001
GRIGIO AVIO/GREY AVIO		5580113001	5581113001	5582113001
ARGENTO COMETA/SILVER COMET		5580123001	5581123001	5582123001
OTTONE VENEZIANO/BRASS		5580133001	5581133001	5582133001
TITANIO/TITANIUM		5580143001	5581143001	5582143001
BRONZO RIACI/RIACI BRONZE		5580153001	5581153001	5582153001
VERDE COSTA/GREEN COAST		5580163001	5581163001	5582163001
TERRA SENESE/SENESE EARTH		5580173001	5581173001	5582173001

N.B./P.N.:
LUNGHEZZA MASSIMA VERSIONE CROMO = 2,00 m / MAXIMUM LENGTH CHROME VERSION = 2.00 m
TESTATE NON INCLUSE / DEAD ENDS NOT INCLUDED



TESTATE DI CHIUSURA / DEAD ENDS

FINITURA STRUTTURA FINISHES	CODICE CODE	FINITURA STRUTTURA FINISHES	CODICE CODE
GRIGIO VESUVIO ANTHRACITE	550400	ARAMEN COPPER	550410
ARGILLA CLAY	550401	GRIGIO AVIO GREY AVIO	550411
ARGENTO OPACO MATT SILVER	550402	ARGENTO COMETA SILVER COMET	550412
BIANCO INTONACO WHITE	550403	OTTONE VENEZIANO BRASS	550413
NERO CARAVAGGIO BLACK	550404	TITANIO/TITANIUM	550414
MOKA MOCHA	550405	BRONZO RIACI/RIACI BRONZE	550415
CROMO CHROME	550408	VERDE COSTA/GREEN COAST	550416
ORO CALIFORNIA GOLD	550409	TERRA SENESE SENESE EARTH	550417

Nel codice sono comprese le viti per il fissaggio delle testate al profilo. Il codice contiene n° 1 testate di chiusura.
The code includes the screws for fixing the heads to the profile. The code contains 1 closing warheads

KIT DI SOSPENSIONE / SUSPENSION KIT

ARTICOLI INCLUSI NEL CODICE ARTICLES INCLUDED IN THE CODE	FINITURA FINISHES	CODICE CODE
Cavo in acciaio 2,00m con puntalino 2.00m steel cable with tip Boccola cromata con regolazione millimetrica Chrome bush with millimeter adjustment	CROMO CHROME	1100508200
Cavo in acciaio 3,00m con puntalino 3.00m steel cable with tip		1100508F30

STAFFA DI FISSAGGIO A CARTONGESSO / MOUNTING CLIP FOR PLASTERBOARD

Accessorio che consente l'incasso del profilo. Accessory that allows the collection of the profile	FINITURA FINISHES	CODICE CODE
Nel codice sono comprese le viti per il fissaggio del profilo alla staffa. The code includes screws for fixing the profile to the bracket	ALLUMINIO NATURALE ALUMINUM	550502

GIUNTI / JOINTS

	FINITURA FINISHES	CODICE CODE
GIUNTO LINEA CONTINUA / STRAIGHT JOINT Accessorio per giunzioni meccaniche lineari Accessory for linear mechanical joints	ALLUMINIO NATURALE ALUMINUM	55050601
GIUNTO 90° ORIZZONTALE / HORIZONTAL JOINT 90° Accessorio per giunzioni meccaniche con angolo 90° Accessory for linear mechanical joints with 90° angle	ALLUMINIO NATURALE ALUMINUM	55050602
GIUNTO 90° VERTICALE INTERNO / VERTICAL JOINT 90° Accessorio per giunzioni meccaniche con angolo 90° Accessory for linear mechanical joints with 90° angle	ALLUMINIO NATURALE ALUMINUM	55050603
GIUNTO 90° ANGOLARE VERTICALE ESTERNO / VERTICAL JOINT 90° Accessorio per giunzioni meccaniche con angolo 90° Accessory for linear mechanical joints with 90° angle	ALLUMINIO NATURALE ALUMINUM	55050604
GIUNTO ANGOLARE A T / ANGULAR T-JOINT Accessorio per giunzioni meccaniche a T Accessory for mechanical T-junctions	ALLUMINIO NATURALE ALUMINUM	55050606
GIUNTO ANGOLARE A X / ANGULAR T-JOINT Accessorio per giunzioni meccaniche a X Accessory for mechanical T-junctions	ALLUMINIO NATURALE ALUMINUM	55050607

Nel codice sono compresi i grani per il fissaggio del giunto / The code includes the grains for fixing the joint.

LAVORAZIONI / PROCESSING

DATI TECNICI TECHNICAL DATA	CODICE CODE
TAGLIO 90° ORIZZONTALE (PER ANGOLI FORMATI DA DUE PROFILI) HORIZONTAL 90° CUT (FOR CORNERS MADE OF TWO PROFILES)	190X
TAGLIO 90° VERTICALE (PER ANGOLI FORMATI DA DUE PROFILI) VERTICAL 90° CUT (FOR CORNERS MADE OF TWO PROFILES)	190Y
TAGLIO ANGOLARE CUSTOM (PER ANGOLI FORMATI DA DUE PROFILI) CUSTOM CORNER CUT (FOR CORNERS MADE OF TWO PROFILES)	190N
ASOLA STANDARD 2X1CM / STANDARD SLOT 2X1CM	100A
ASOLA CUSTOMIZZATA / CUSTOM SLOT	100N
FORO / HOLE	100F
CABLAGGIO - COLLAUDO - CE LED AL CENTIMETRO INSTALLATION AND TESTING LED MODULE AT CENTIMETER	1101
CONNETTORE MASCHIO/FEMMINA MALE/FEMALE CONNECTOR	98CFM
CONNETTORE MASCHIO/FEMMINA MONTATO NEL PRODOTTO MALE/FEMALE CONNECTOR FITTED IN THE PRODUCT	98MFM
CAVO DI ALIMENTAZIONE 2X0,75 TONDO TRASPARENTE 1CM POWER CABLE 2X0,75 ROUND TRANSPARENT 1CM	98CTT001

**“tecnologia al top
per qualità, resa cromatica,
lumen emessi, temperatura colore”**

ZER075 costruito in estruso di alluminio si avvale della tecnologia degli schermi in policarbonato per diffondere la luce per mezzo di LED al top, per qualità, resa cromatica, lumen emessi, ed accurata selezione della temperatura colore, scelta in base al progetto scenografico che vogliamo ottenere. ZER035 offre una gamma di finiture e di accessori, i tagli lineari e a 45° o su MISURA, rendono realizzabile qualsiasi progetto sia esso da incasso a parete, plafone o sospensione.

ZER075 is made in extruded aluminium. Use polycarbonate technology for diffusing led light with high precision, use high quality like led, colour rendering, lumen output and accurate colour temperature for ensuring optimal results for each type of project. ZER035 offers a wide gamma of finishing's and accessories, several lengths, 45°cuts or completely customized. With Zer035 it's possible to realize any kind of projects like wall-recessed, surface mounting or pendant. Epedio comnist

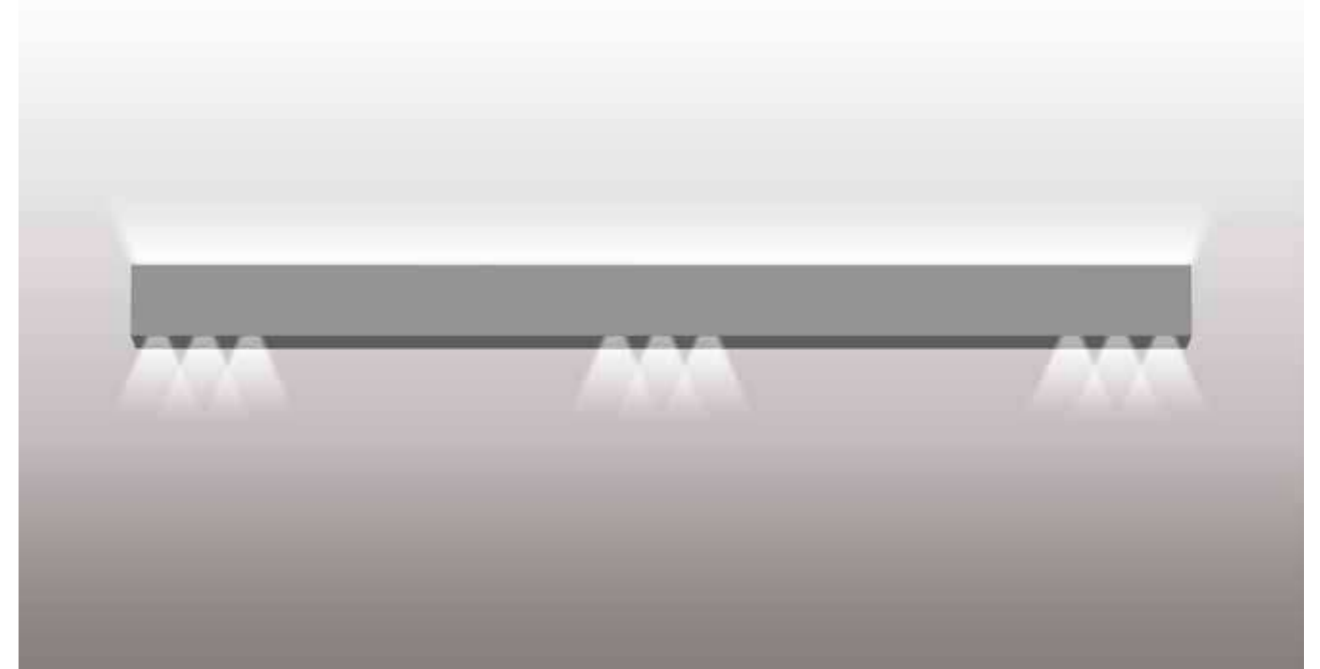

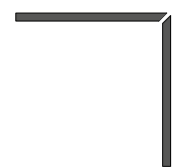
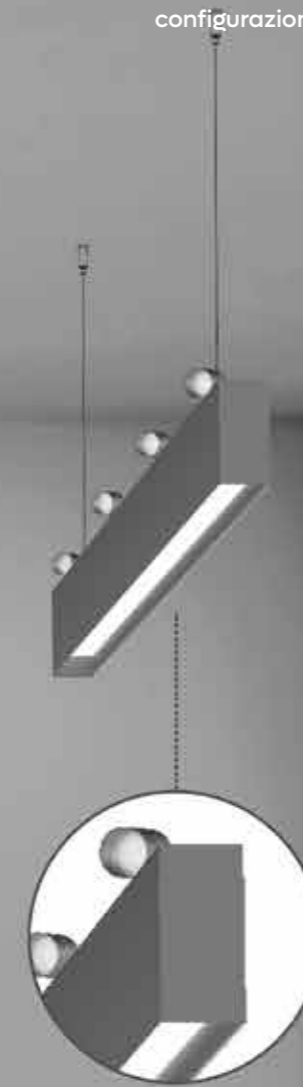
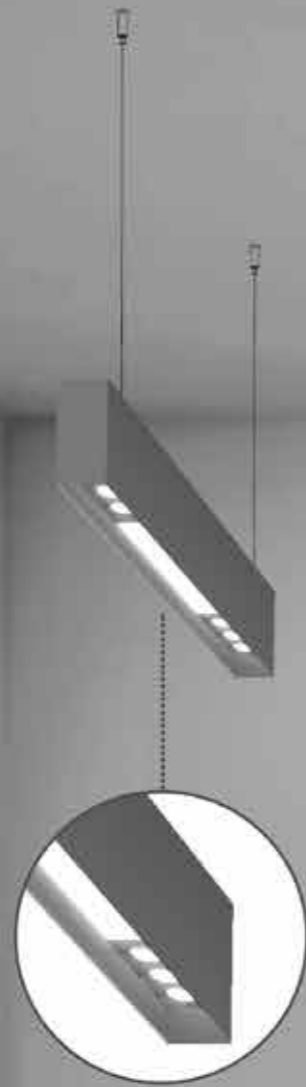

A. COMPOSIZIONE ANGOLARE A "L"
A. L-ANGLE COMPOSITION

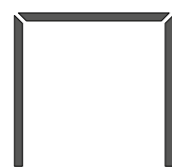

B. COMPOSIZIONE ANGOLARE A "C"
B. C-ANGLE COMPOSITION

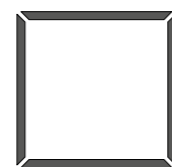

C. COMPOSIZIONE POLIGONALE (QUADRATO/RETTANGOLO)
C. POLYGONAL COMPOSITION (SQUARE / RECTANGLE)



D. COMPOSIZIONE POLIGONALE (PENTAGONO/ESAGONO)
D. POLYGONAL COMPOSITION (PENTAGON / HEX)

INSTALLAZIONE A SOSPENSIONE
SUSPENSION

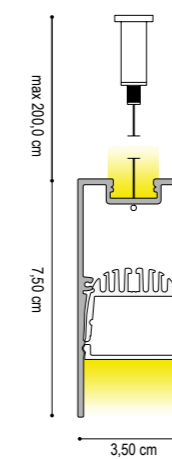

ESEMPIO 1 / TYPE 1

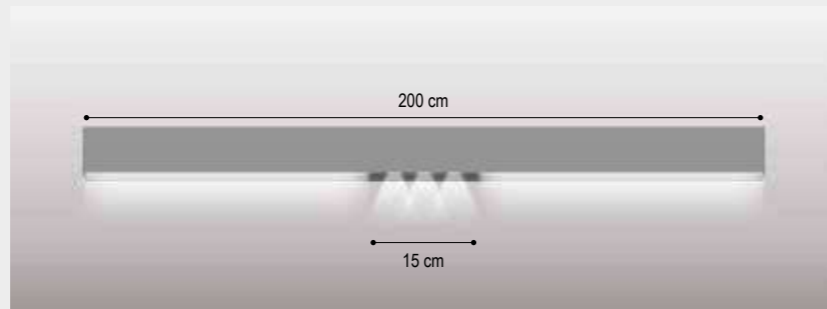

VISTA FRONTALE / FRONT VIEW

ESEMPIO 2 / TYPE 2



VISTA LATERALE / SIDE VIEW

ESEMPIO 3 / TYPE 3

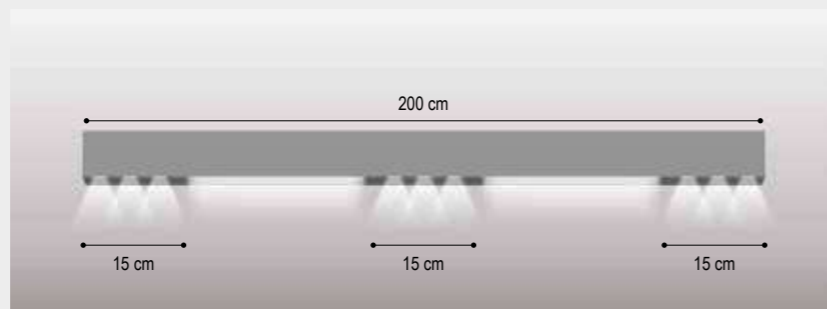

VISTA FRONTALE / FRONT VIEW

ESEMPIO 4 / TYPE 4

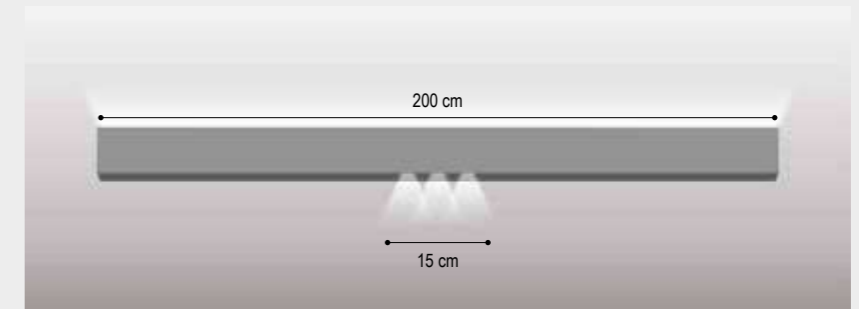

VISTA FRONTALE / FRONT VIEW

ESEMPIO 5 / TYPE 5

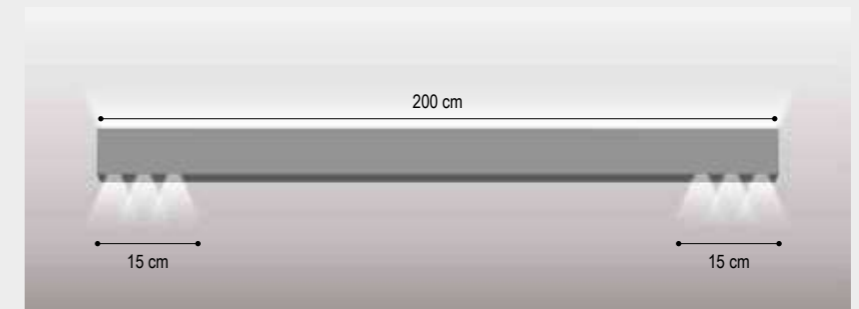

VISTA LATERALE / SIDE VIEW

ESEMPIO 6 / TYPE 6

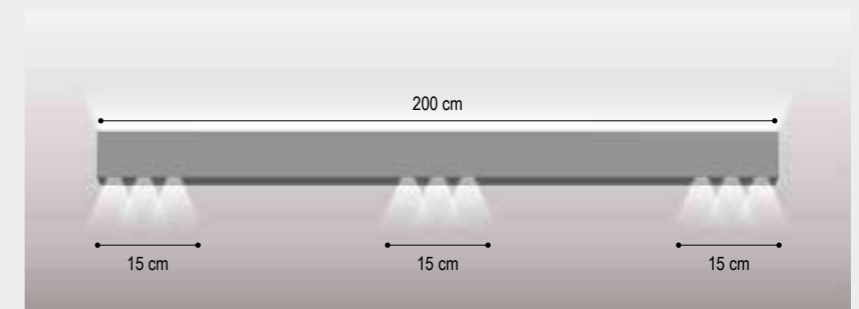

VISTA FRONTALE / FRONT VIEW

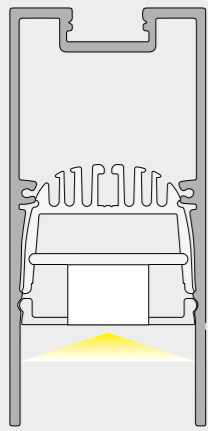

VISTA LATERALE / SIDE VIEW

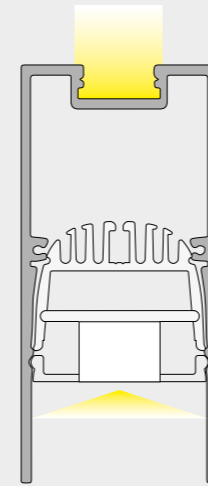

VISTA LATERALE / SIDE VIEW

zero75

led integrato

integrated led

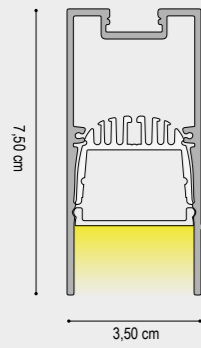

DATI TECNICI
TECHNICAL DATA

	1 cm - 2700K	1 cm - 3000K	1 cm - 4000K
Nominal LED Flux:	2100 lm/m	2200 lm/m	2350 lm/m
Flux Tot:	1680 lm/m	1760 lm/m	1880 lm/m
Output:	105 lm/W	110 lm/W	117 lm/W
CCT:	2700 K	3000 K	4000 K
CRI:	>90	>90	>90
Power Tot:	20.0 W/m	20.0 W/m	20.0 W/m
Weight:	0.90 Kg/m	0.90 Kg/m	0.90 Kg/m
Profilo/Profile:	Alluminio/aluminum		Cover: Opale/opal

DRIVER NON INCLUSO / NOT INCLUDED

CAVO ALIMENTAZIONE: 50 cm
ALIMENTATION CABLE: 50 cm

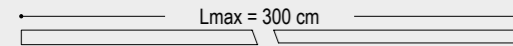

zero75 — ugr<19

led integrato

integrated led

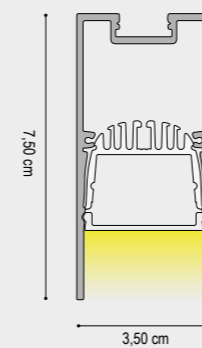

DATI TECNICI
TECHNICAL DATA

	1 cm - 2700K	1 cm - 3000K	1 cm - 4000K
Nominal LED Flux:	2100 lm/m	2200 lm/m	2350 lm/m
Flux Tot:	1890 lm/m	1980 lm/m	2115 lm/m
Output:	105 lm/W	110 lm/W	117 lm/W
CCT:	2700 K	3000 K	4000 K
CRI:	>90	>90	>90
Power Tot:	20.0 W/m	20.0 W/m	20.0 W/m
Weight:	0.90 Kg/m	0.90 Kg/m	0.90 Kg/m
Profilo/Profile:	Alluminio/aluminum		Cover: Prismaticata/Prismatic

DRIVER NON INCLUSO / NOT INCLUDED

CAVO ALIMENTAZIONE: 50 cm
ALIMENTATION CABLE: 50 cm

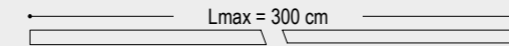

FINITURA STRUTTURA FINISHES	DIFFUSORE DIFFUSER	1 cm - 2700K	1 cm - 3000K	1 cm - 4000K
		CODICE CODE	CODICE CODE	CODICE CODE
GRIGIO VESUVIO ANTHRACITE	OPALE/OPAL	754600001	754700001	754800001
ARGILLA CLAY		754601001	754701001	754801001
ARGENTO OPACO/MATT SILVER		754602001	754702001	754802001
BIANCO INTONACO/WHITE		754603001	754703001	754803001
NERO CARAVAGGIO/BLACK		754604001	754704001	754804001
MOKA MOCHA		754605001	754705001	754805001
CROMO/CHROME		754608001	754708001	754808001
ORO CALIFORNIA/GOLD		754609001	754709001	754809001
ARAMEN COPPER		754610001	754710001	754810001
GRIGIO AVIO/GREY AVIO		754611001	754711001	754811001
ARGENTO COMETA/SILVER COMET		754612001	754712001	754812001
OTTONE VENEZIANO/BRASS		754613001	754713001	754813001
TITANIO/TITANIUM		754614001	754714001	754814001
BRONZO RIACI/RIACI BRONZE		754615001	754715001	754815001
VERDE COSTA/GREEN COAST		754616001	754716001	754816001
TERRA SENESE SENESE EARTH		754617001	754717001	754817001

N.B./P.N.:
LUNGHEZZA MASSIMA VERSIONE CROMO = 2,00 m / MAXIMUM LENGTH CHROME VERSION = 2.00 m
TESTATE NON INCLUSE / DEAD ENDS NOT INCLUDED

FINITURA STRUTTURA FINISHES	DIFFUSORE DIFFUSER	1 cm - 2700K	1 cm - 3000K	1 cm - 4000K
		CODICE CODE	CODICE CODE	CODICE CODE
GRIGIO VESUVIO ANTHRACITE	PRISMATIZZATO PRISMATIC	7546003001	7547003001	7548003001
ARGILLA CLAY		7546013001	7547013001	7548013001
ARGENTO OPACO/MATT SILVER		7546023001	7547023001	7548023001
BIANCO INTONACO/WHITE		7546033001	7547033001	7548033001
NERO CARAVAGGIO/BLACK		7546043001	7547043001	7548043001
MOKA MOCHA		7546053001	7547053001	7548053001
CROMO/CHROME		7546083001	7547083001	7548083001
ORO CALIFORNIA/GOLD		7546093001	7547093001	7548093001
ARAMEN COPPER		7546103001	7547103001	7548103001
GRIGIO AVIO/GREY AVIO		7546113001	7547113001	7548113001
ARGENTO COMETA/SILVER COMET		7546123001	7547123001	7548123001
OTTONE VENEZIANO/BRASS		7546133001	7547133001	7548133001
TITANIO/TITANIUM		7546143001	7547143001	7548143001
BRONZO RIACI/RIACI BRONZE		7546153001	7547153001	7548153001
VERDE COSTA/GREEN COAST		7546163001	7547163001	7548163001
TERRA SENESE SENESE EARTH		7546173001	7547173001	7548173001

N.B./P.N.:
LUNGHEZZA MASSIMA VERSIONE CROMO = 2,00 m / MAXIMUM LENGTH CHROME VERSION = 2.00 m
TESTATE NON INCLUSE / DEAD ENDS NOT INCLUDED



zero75

led integrato

integrated led

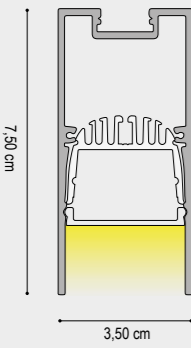

DATI TECNICI
TECHNICAL DATA

	1 cm - 2700K	1 cm - 3000K	1 cm - 4000K
Nominal LED Flux:	2916 lm/m	3024 lm/m	3125 lm/m
Flux Tot:	2333 lm/m	2419 lm/m	2500 lm/m
Output:	135 lm/W	140 lm/W	145 lm/W
CCT:	2700 K	3000 K	4000 K
CRI:	>90	>90	>90
Power Tot:	22 W/m	22 W/m	22 W/m
Weight:	0.90 Kg/m	0.90 Kg	0.90 Kg
Profilo/Profile:	Alluminio/aluminum		Cover: Opale/opal

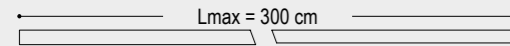

DRIVER NON INCLUSO / NOT INCLUDED

CAVO ALIMENTAZIONE: 50 cm
ALIMENTATION CABLE: 50 cm

FINITURA STRUTTURA
FINISHES

- GRIGIO VESUVIO ANTHRACITE
- ARGILLA CLAY
- ARGENTO OPACO/MATT SILVER
- BIANCO INTONACO/WHITE
- NERO CARAVAGGIO BLACK
- MOKA MOCHA
- CROMO CHROME
- ORO CALIFORNIA/GOLD
- ARAMEN COPPER
- GRIGIO AVIO/GREY AVIO
- ARGENTO COMETA/SILVER COMET
- OTTONE VENEZIANO/BRASS
- TITANIO/TITANIUM
- BRONZO RIACI/RIACI BRONZE
- VERDE COSTA/GREEN COAST
- TERRA SENESE SENESE EARTH

DIFFUSORE
DIFFUSER

OPALE/OPAL

	1 cm - 2700K	1 cm - 3000K	1 cm - 4000K
CODICE CODE	CODICE CODE	CODICE CODE	CODICE CODE
7586000001	7587000001	7588000001	
7586010001	7587010001	7588010001	
7586020001	7587020001	7588020001	
7586030001	7587030001	7588030001	
7586040001	7587040001	7588040001	
7586050001	7587050001	7588050001	
7586080001	7587080001	7588080001	
7586090001	7587090001	7588090001	
7586100001	7587100001	7588100001	
7586110001	7587110001	7588110001	
7586120001	7587120001	7588120001	
7586130001	7587130001	7588130001	
7586140001	7587140001	7588140001	
7586150001	7587150001	7588150001	
7586160001	7587160001	7588160001	
7586170001	7587170001	7588170001	

N.B./P.N.:

LUNGHEZZA MASSIMA VERSIONE CROMO = 2,00 m / MAXIMUM LENGTH CHROME VERSION = 2.00 m
TESTATE NON INCLUDE / DEAD ENDS NOT INCLUDED



zero75 — ugr<19

led integrato

integrated led

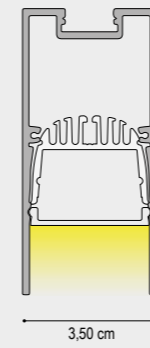

DATI TECNICI
TECHNICAL DATA

	1 cm - 2700K	1 cm - 3000K	1 cm - 4000K
Nominal LED Flux:	2916 lm/m	3024 lm/m	3125 lm/m
Flux Tot:	2624 lm/m	2722 lm/m	2812 lm/m
Output:	135 lm/W	140 lm/W	145 lm/W
CCT:	2700 K	3000 K	4000 K
CRI:	>90	>90	>90
Power Tot:	22 W/m	22 W/m	22 W/m
Weight:	0.90 Kg/m	0.90 Kg	0.90 Kg
Profilo/Profile:	Alluminio/aluminum		Cover: Prismaticata/Prismatic

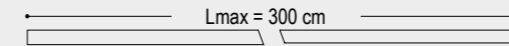

DRIVER NON INCLUSO / NOT INCLUDED

CAVO ALIMENTAZIONE: 50 cm
ALIMENTATION CABLE: 50 cm

FINITURA STRUTTURA
FINISHES

- GRIGIO VESUVIO ANTHRACITE
- ARGILLA CLAY
- ARGENTO OPACO/MATT SILVER
- BIANCO INTONACO/WHITE
- NERO CARAVAGGIO BLACK
- MOKA MOCHA
- CROMO CHROME
- ORO CALIFORNIA/GOLD
- ARAMEN COPPER
- GRIGIO AVIO/GREY AVIO
- ARGENTO COMETA/SILVER COMET
- OTTONE VENEZIANO/BRASS
- TITANIO/TITANIUM
- BRONZO RIACI/RIACI BRONZE
- VERDE COSTA/GREEN COAST
- TERRA SENESE SENESE EARTH

DIFFUSORE
DIFFUSER

PRISMATIZZATO
PRISMATIC

	1 cm - 2700K	1 cm - 3000K	1 cm - 4000K
CODICE CODE	CODICE CODE	CODICE CODE	CODICE CODE
7586003001	7587003001	7588003001	
7586013001	7587013001	7588013001	
7586023001	7587023001	7588023001	
7586033001	7587033001	7588033001	
7586043001	7587043001	7588043001	
7586053001	7587053001	7588053001	
7586083001	7587083001	7588083001	
7586093001	7587093001	7588093001	
7586103001	7587103001	7588103001	
7586113001	7587113001	7588113001	
7586123001	7587123001	7588123001	
7586133001	7587133001	7588133001	
7586143001	7587143001	7588143001	
7586153001	7587153001	7588153001	
7586163001	7587163001	7588163001	
7586173001	7587173001	7588173001	

N.B./P.N.:

LUNGHEZZA MASSIMA VERSIONE CROMO = 2,00 m / MAXIMUM LENGTH CHROME VERSION = 2.00 m
TESTATE NON INCLUDE / DEAD ENDS NOT INCLUDED



zero75

led integrato

integrated led

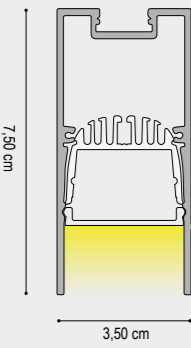

DATI TECNICI
TECHNICAL DATA

	1 cm - 2700K	1 cm - 3000K	1 cm - 4000K
Nominal LED Flux:	3750 lm/m	3900 lm/m	4050 lm/m
Flux Tot:	3000 lm/m	3120 lm/m	3240 lm/m
Output:	125 lm/W	130 lm/W	135 lm/W
CCT:	2700 K	3000 K	4000 K
CRI:	>90	>90	>90
Power Tot:	30.0 W/m	30.0 W/m	30.0 W/m
Weight:	0.90 Kg/m	0.90 Kg/m	0.90 Kg/m

Profilo/Profile: Alluminio/aluminum

Cover: Opale/opal

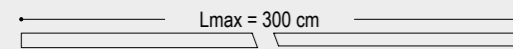

DRIVER NON INCLUSO / NOT INCLUDED

CAVO ALIMENTAZIONE: 50 cm
ALIMENTATION CABLE: 50 cm

FINITURA STRUTTURA
FINISHES

- GRIGIO VESUVIO ANTHRACITE
- ARGILLA CLAY
- ARGENTO OPACO MATT SILVER
- BIANCO INTONACO/WHITE
- NERO CARAVAGGIO BLACK
- MOKA MOCHA
- CROMO CHROME
- ORO CALIFORNIA/GOLD
- ARAMEN COPPER
- GRIGIO AVIO/GREY AVIO
- ARGENTO COMETA/SILVER COMET
- OTTONE VENEZIANO BRASS
- TITANIO/TITANIUM
- BRONZO RIACI/RIACI BRONZE
- VERDE COSTA/GREEN COAST
- TERRA SENESE SENESE EARTH

DIFFUSORE
DIFFUSER

OPALE/OPAL

	1 cm - 2700K	1 cm - 3000K	1 cm - 4000K
CODICE CODE			
7580000001	7581000001	7582000001	
7580010001	7581010001	7582010001	
7580020001	7581020001	7582020001	
7580030001	7581030001	7582030001	
7580040001	7581040001	7582040001	
7580050001	7581050001	7582050001	
7580080001	7581080001	7582080001	
7580090001	7581090001	7582090001	
7580100001	7581100001	7582100001	
7580110001	7581110001	7582110001	
7580120001	7581120001	7582120001	
7580130001	7581130001	7582130001	
7580140001	7581140001	7582140001	
7580150001	7581150001	7582150001	
7580160001	7581160001	7582160001	
7580170001	7581170001	7582170001	

N.B./P.N.:
LUNGHEZZA MASSIMA VERSIONE CROMO = 2,00 m / MAXIMUM LENGTH CHROME VERSION = 2.00 m
TESTATE NON INCLUSE / DEAD ENDS NOT INCLUDED



zero75 — ugr<19

led integrato

integrated led

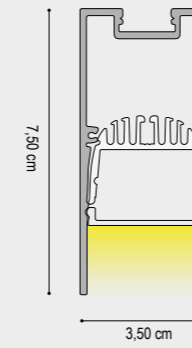

DATI TECNICI
TECHNICAL DATA

	1 cm - 2700K	1 cm - 3000K	1 cm - 4000K
Nominal LED Flux:	3750 lm/m	3900 lm/m	4050 lm/m
Flux Tot:	3375 lm/m	3510 lm/m	3645 lm/m
Output:	125 lm/W	130 lm/W	135 lm/W
CCT:	2700 K	3000 K	4000 K
CRI:	>90	>90	>90
Power Tot:	30.0 W/m	30.0 W/m	30.0 W/m
Weight:	0.90 Kg/m	0.90 Kg/m	0.90 Kg/m

Profilo/Profile: Alluminio/aluminum

Cover: Prismatizzata/Prismatic

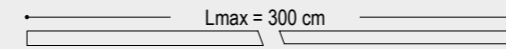

DRIVER NON INCLUSO / NOT INCLUDED

CAVO ALIMENTAZIONE: 50 cm
ALIMENTATION CABLE: 50 cm

FINITURA STRUTTURA
FINISHES

- GRIGIO VESUVIO ANTHRACITE
- ARGILLA CLAY
- ARGENTO OPACO MATT SILVER
- BIANCO INTONACO/WHITE
- NERO CARAVAGGIO BLACK
- MOKA MOCHA
- CROMO CHROME
- ORO CALIFORNIA/GOLD
- ARAMEN COPPER
- GRIGIO AVIO/GREY AVIO
- ARGENTO COMETA/SILVER COMET
- OTTONE VENEZIANO BRASS
- TITANIO/TITANIUM
- BRONZO RIACI/RIACI BRONZE
- VERDE COSTA/GREEN COAST
- TERRA SENESE SENESE EARTH

DIFFUSORE
DIFFUSER

PRISMATIZZATO
PRISMATIC

	1 cm - 2700K	1 cm - 3000K	1 cm - 4000K
CODICE CODE			
7580003001	7581003001	7582003001	
7580013001	7581013001	7582013001	
7580023001	7581023001	7582023001	
7580033001	7581033001	7582033001	
7580043001	7581043001	7582043001	
7580053001	7581053001	7582053001	
7580083001	7581083001	7582083001	
7580093001	7581093001	7582093001	
7580103001	7581103001	7582103001	
7580113001	7581113001	7582113001	
7580123001	7581123001	7582123001	
7580133001	7581133001	7582133001	
7580143001	7581143001	7582143001	
7580153001	7581153001	7582153001	
7580163001	7581163001	7582163001	
7580173001	7581173001	7582173001	

N.B./P.N.:
LUNGHEZZA MASSIMA VERSIONE CROMO = 2,00 m / MAXIMUM LENGTH CHROME VERSION = 2.00 m
TESTATE NON INCLUSE / DEAD ENDS NOT INCLUDED



zero75

led integrato

integrated led

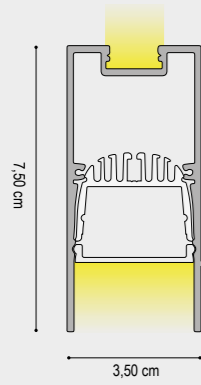

DATI TECNICI
TECHNICAL DATA

	1 cm - 2700K	1 cm - 3000K	1 cm - 4000K
Nominal LED Flux:	↑ 1440 lm - 2100 lm ↓	↑ 1440 lm - 2200 lm ↓	↑ 1440 lm - 2350 lm/m ↓
Flux Tot:	↑ 1152 lm - 1680 lm ↓	↑ 1152 lm - 1760 lm ↓	↑ 1152 lm - 1880 lm/m ↓
Output:	↑ 100 lm/W - 105 lm/W ↓	↑ 100 lm/W - 110 lm/W ↓	↑ 100 lm/W - 117 lm/W ↓
CCT:	2700 K	3000 K	4000 K
CRI:	>90	>90	>90
Power Tot:	35.0 W/m	35.0 W/m	35.0 W/m
Weight:	0.90 Kg/m	0.90 Kg/m	0.90 Kg/m
Profilo/Profile:	Alluminio/aluminum		Cover: Opale/opal Satinata/Satin

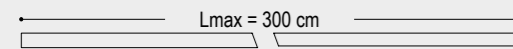

DRIVER NON INCLUSO / NOT INCLUDED

CAVO ALIMENTAZIONE: 50 cm
ALIMENTATION CABLE: 50 cm

zero75 — ugr<19

led integrato

integrated led

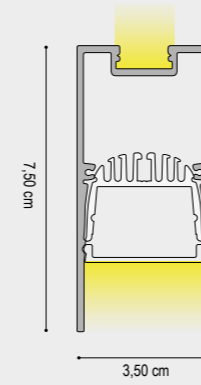

DATI TECNICI
TECHNICAL DATA

	1 cm - 2700K	1 cm - 3000K	1 cm - 4000K
Nominal LED Flux:	↑ 1440 lm - 2100 lm ↓	↑ 1440 lm - 2200 lm ↓	↑ 1440 lm - 2350 lm/m ↓
Flux Tot:	↑ 1296 lm - 1890 lm ↓	↑ 1296 lm - 1980 lm ↓	↑ 1296 lm - 2115 lm/m ↓
Output:	↑ 100 lm/W - 105 lm/W ↓	↑ 100 lm/W - 110 lm/W ↓	↑ 100 lm/W - 117 lm/W ↓
CCT:	2700 K	3000 K	4000 K
CRI:	>90	>90	>90
Power Tot:	35.0 W/m	35.0 W/m	35.0 W/m
Weight:	0.90 Kg/m	0.90 Kg/m	0.90 Kg/m
Profilo/Profile:	Alluminio/aluminum		Cover: Prismatizzata/Prismatic Satinata/Satin

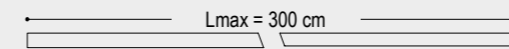

DRIVER NON INCLUSO / NOT INCLUDED

CAVO ALIMENTAZIONE: 50 cm
ALIMENTATION CABLE: 50 cm

FINITURA STRUTTURA FINISHES	DIFFUSORE DIFFUSER	1 cm - 2700K CODICE CODE	1 cm - 3000K CODICE CODE	1 cm - 4000K CODICE CODE
GRIGIO VESUVIO ANTHRACITE		75G4600001	75G4700001	75G4800001
ARGILLA CLAY		75G4601001	75G4701001	75G4801001
ARGENTO OPACO MATT SILVER		75G4602001	75G4702001	75G4802001
BIANCO INTONACO/WHITE		75G4603001	75G4703001	75G4803001
NERO CARAVAGGIO BLACK		75G4604001	75G4704001	75G4804001
MOKA MOCHA		75G4605001	75G4705001	75G4805001
CROMO CHROME		75G4608001	75G4708001	75G4808001
ORO CALIFORNIA/GOLD	SATINATA/SATIN	75G4609001	75G4709001	75G4809001
ARAMEN COPPER	OPALE/OPAL	75G4610001	75G4710001	75G4810001
GRIGIO AVIO/GREY AVIO		75G4611001	75G4711001	75G4811001
ARGENTO COMETA/SILVER COMET		75G4612001	75G4712001	75G4812001
OTTONE VENEZIANO BRASS		75G4613001	75G4713001	75G4813001
TITANIO/TITANIUM		75G4614001	75G4714001	75G4814001
BRONZO RIACI/RIACI BRONZE		75G4615001	75G4715001	75G4815001
VERDE COSTA/GREEN COAST		75G4616001	75G4716001	75G4816001
TERRA SENESE SENESE EARTH		75G4617001	75G4717001	75G4817001

N.B./P.N.:
LUNGHEZZA MASSIMA VERSIONE CROMO = 2,00 m / MAXIMUM LENGTH CHROME VERSION = 2.00 m
TESTATE NON INCLUSE / DEAD ENDS NOT INCLUDED

FINITURA STRUTTURA FINISHES	DIFFUSORE DIFFUSER	1 cm - 2700K CODICE CODE	1 cm - 3000K CODICE CODE	1 cm - 4000K CODICE CODE
GRIGIO VESUVIO ANTHRACITE		75G4600301	75G4700301	75G4800301
ARGILLA CLAY		75G4601301	75G4701301	75G4801301
ARGENTO OPACO MATT SILVER		75G4602301	75G4702301	75G4802301
BIANCO INTONACO/WHITE		75G4603301	75G4703301	75G4803301
NERO CARAVAGGIO BLACK		75G4604301	75G4704301	75G4804301
MOKA MOCHA		75G4605301	75G4705301	75G4805301
CROMO CHROME	SATINATA/SATIN	75G4608301	75G4708301	75G4808301
ORO CALIFORNIA/GOLD	PRISMATIZZATO PRISMATIC	75G4609301	75G4709301	75G4809301
ARAMEN COPPER		75G4610301	75G4710301	75G4810301
GRIGIO AVIO/GREY AVIO		75G4611301	75G4711301	75G4811301
ARGENTO COMETA/SILVER COMET		75G4612301	75G4712301	75G4812301
OTTONE VENEZIANO BRASS		75G4613301	75G4713301	75G4813301
TITANIO/TITANIUM		75G4614301	75G4714301	75G4814301
BRONZO RIACI/RIACI BRONZE		75G4615301	75G4715301	75G4815301
VERDE COSTA/GREEN COAST		75G4616301	75G4716301	75G4816301
TERRA SENESE SENESE EARTH		75G4617301	75G4717301	75G4817301

N.B./P.N.:
LUNGHEZZA MASSIMA VERSIONE CROMO = 2,00 m / MAXIMUM LENGTH CHROME VERSION = 2.00 m
TESTATE NON INCLUSE / DEAD ENDS NOT INCLUDED



zero75

led integrato

integrated led

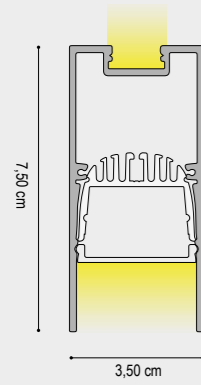

DATI TECNICI
TECHNICAL DATA

	1 cm - 2700K	1 cm - 3000K	1 cm - 4000K
Nominal LED Flux:	↑ 1440 lm/m - 2916 lm/m ↓	↑ 1440 lm/m - 3024 lm/m ↓	↑ 1440 lm/m - 3125 lm/m ↓
Flux Tot:	↑ 1152 lm/m - 2333 lm/m ↓	↑ 1152 lm/m - 2419 lm/m ↓	↑ 1152 lm/m - 2500 lm/m ↓
Output:	↑ 100 lm/W - 135 lm/W ↓	↑ 100 lm/W - 140 lm/W ↓	↑ 100 lm/W - 145 lm/W ↓
CCT:	2700 K	3000 K	4000 K
CRI:	>90	>90	>90
Power Tot:	36.0 W/m	36.0 W/m	36.0 W/m
Weight:	0.90 Kg/m	0.90 Kg	0.90 Kg

Profilo/Profile: Alluminio/aluminum

Cover: Opale/opal
Satinata/Satin

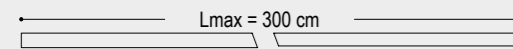

DRIVER NON INCLUSO / NOT INCLUDED

CAVO ALIMENTAZIONE: 50 cm
ALIMENTATION CABLE: 50 cm

zero75 — ugr<19

led integrato

integrated led

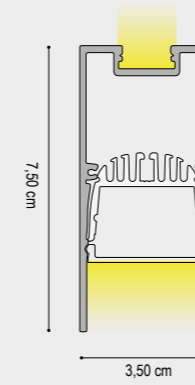

DATI TECNICI
TECHNICAL DATA

	1 cm - 2700K	1 cm - 3000K	1 cm - 4000K
Nominal LED Flux:	↑ 1440 lm/m - 2916 lm/m ↓	↑ 1440 lm/m - 3024 lm/m ↓	↑ 1440 lm/m - 3125 lm/m ↓
Flux Tot:	↑ 1296 lm/m - 2624 lm/m ↓	↑ 1296 lm/m - 2722 lm/m ↓	↑ 1296 lm/m - 2812 lm/m ↓
Output:	↑ 100 lm/W - 135 lm/W ↓	↑ 100 lm/W - 140 lm/W ↓	↑ 100 lm/W - 145 lm/W ↓
CCT:	2700 K	3000 K	4000 K
CRI:	>90	>90	>90
Power Tot:	36.0 W/m	36.0 W/m	36.0 W/m
Weight:	0.90 Kg/m	0.90 Kg	0.90 Kg

Profilo/Profile: Alluminio/aluminum

Cover: Prismaticata/Prismatic
Satinata/Satin

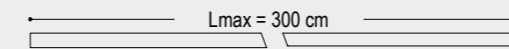

DRIVER NON INCLUSO / NOT INCLUDED

CAVO ALIMENTAZIONE: 50 cm
ALIMENTATION CABLE: 50 cm

FINITURA STRUTTURA FINISHES	DIFFUSORE DIFFUSER	1 cm - 2700K	1 cm - 3000K	1 cm - 4000K
		CODICE CODE	CODICE CODE	CODICE CODE
GRIGIO VESUVIO ANTHRACITE	SATINATA/SATIN OPALE/OPAL	75G8600001	75G8700001	75G8800001
ARGILLA CLAY		75G8601001	75G8701001	75G8801001
ARGENTO OPACO MATT SILVER		75G8602001	75G8702001	75G8802001
BIANCO INTONACO/WHITE		75G8603001	75G8703001	75G8803001
NERO CARAVAGGIO BLACK		75G8604001	75G8704001	75G8804001
MOKA MOCHA		75G8605001	75G8705001	75G8805001
CROMO CHROME		75G8608301	75G8708301	75G8808301
ORO CALIFORNIA/GOLD		75G8609001	75G8709001	75G8809001
ARAMEN COPPER		75G8610001	75G8710001	75G8810001
GRIGIO AVIO/GREY AVIO		75G8611001	75G8711001	75G8811001
ARGENTO COMETA/SILVER COMET		75G8612001	75G8712001	75G8812001
OTTONE VENEZIANO BRASS		75G8613001	75G8713001	75G8813001
TITANIO/TITANIUM		75G8614001	75G8714001	75G8814001
BRONZO RIACI/RIACI BRONZE		75G8615001	75G8715001	75G8815001
VERDE COSTA/GREEN COAST		75G8616001	75G8716001	75G8816001
TERRA SENESE SENESE EARTH		75G8617001	75G8717001	75G8817001

N.B./P.N.:
LUNGHEZZA MASSIMA VERSIONE CROMO = 2,00 m / MAXIMUM LENGTH CHROME VERSION = 2.00 m
TESTATE NON INCLUSE / DEAD ENDS NOT INCLUDED

FINITURA STRUTTURA FINISHES	DIFFUSORE DIFFUSER	1 cm - 2700K	1 cm - 3000K	1 cm - 4000K
		CODICE CODE	CODICE CODE	CODICE CODE
GRIGIO VESUVIO ANTHRACITE	SATINATA/SATIN PRISMATIZZATO PRISMATIC	75G8600301	75G8700301	75G8800301
ARGILLA CLAY		75G8601301	75G8701301	75G8801301
ARGENTO OPACO MATT SILVER		75G8602301	75G8702301	75G8802301
BIANCO INTONACO/WHITE		75G8603301	75G8703301	75G8803301
NERO CARAVAGGIO BLACK		75G8604301	75G8704301	75G8804301
MOKA MOCHA		75G8605301	75G8705301	75G8805301
CROMO CHROME		75G8608301	75G8708301	75G8808301
ORO CALIFORNIA/GOLD		75G8609301	75G8709301	75G8809301
ARAMEN COPPER		75G8610301	75G8710301	75G8810301
GRIGIO AVIO/GREY AVIO		75G8611301	75G8711301	75G8811301
ARGENTO COMETA/SILVER COMET		75G8612301	75G8712301	75G8812301
OTTONE VENEZIANO BRASS		75G8613301	75G8713301	75G8813301
TITANIO/TITANIUM		75G8614301	75G8714301	75G8814301
BRONZO RIACI/RIACI BRONZE		75G8615301	75G8715301	75G8815301
VERDE COSTA/GREEN COAST		75G8616301	75G8716301	75G8816301
TERRA SENESE SENESE EARTH		75G8617301	75G8717301	75G8817301

N.B./P.N.:
LUNGHEZZA MASSIMA VERSIONE CROMO = 2,00 m / MAXIMUM LENGTH CHROME VERSION = 2.00 m
TESTATE NON INCLUSE / DEAD ENDS NOT INCLUDED



zero75

led integrato

integrated led

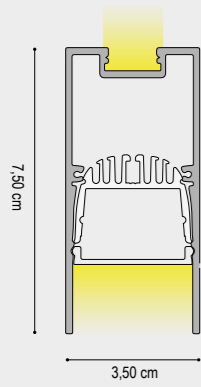

DATI TECNICI
TECHNICAL DATA

	1 cm - 2700K	1 cm - 3000K	1 cm - 4000K
Nominal LED Flux:	↑1440 lm/m - 3750 lm/m ↓	↑1440 lm/m - 3900 lm/m ↓	↑1440 lm/m - 4050 lm/m ↓
Flux Tot:	↑1152 lm/m - 3000 lm/m ↓	↑1152 lm/m - 3120 lm/m ↓	↑1152 lm/m - 3240 lm/m ↓
Output:	↑100 lm/W - 125 lm/W ↓	↑100 lm/W - 1130 lm/W ↓	↑100 lm/W - 1135 lm/W ↓
CCT:	2700 K	3000 K	4000 K
CRI:	>90	>90	>90
Power Tot:	45.0 W/m	45.0 W/m	45.0 W/m
Weight:	0.90 Kg/m	0.90 Kg/m	0.90 Kg/m
Profilo/Profile:	Alluminio/aluminum		Cover: Opale/opal Satinata/Satin

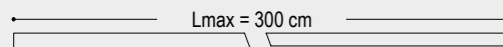

DRIVER NON INCLUSO / NOT INCLUDED

CAVO ALIMENTAZIONE: 50 cm
ALIMENTATION CABLE: 50 cm

FINITURA STRUTTURA
FINISHES

- GRIGIO VESUVIO ANTHRACITE
- ARGILLA CLAY
- ARGENTO OPACO/MATT SILVER
- BIANCO INTONACO/WHITE
- NERO CARAVAGGIO BLACK
- MOKA MOCHA
- CROMO CHROME
- ORO CALIFORNIA GOLD
- ARAMEN COPPER
- GRIGIO AVIO GREY AVIO
- ARGENTO COMETA/SILVER COMET
- OTTONE VENEZIANO BRASS
- TITANIO/TITANIUM
- BRONZO RIACI/RIACI BRONZE
- VERDE COSTA/GREEN COAST
- TERRA SENESE SENESE EARTH

DIFFUSORE
DIFFUSER

- SATINATA/SATIN
- OPALE/OPAL

	1 cm - 2700K	1 cm - 3000K	1 cm - 4000K	PREZZO PRICE
CODICE CODE	75G8000001	75G8100001	75G8200001	€ 2,22
	75G8001001	75G8101001	75G8201001	€ 2,22
	75G8002001	75G8102001	75G8202001	€ 2,17
	75G8003001	75G8103001	75G8203001	€ 2,17
	75G8004001	75G8104001	75G8204001	€ 2,17
	75G8005001	75G8105001	75G8205001	€ 2,22
	75G8008001	75G8108001	75G8208001	€ 2,93
	75G8009001	75G8109001	75G8209001	€ 2,51
	75G8010001	75G8110001	75G8210001	€ 2,93
	75G8011001	75G8111001	75G8211001	€ 2,51
	75G8012001	75G8112001	75G8212001	€ 2,51
	75G8013001	75G8113001	75G8213001	€ 2,51
	75G8014001	75G8114001	75G8214001	€ 2,51
	75G8015001	75G8115001	75G8215001	€ 2,51
	75G8016001	75G8116001	75G8216001	€ 2,51
	75G8017001	75G8117001	75G8217001	€ 2,22

N.B./P.N.:
LUNGHEZZA MASSIMA VERSIONE CROMO = 2,00 m / MAXIMUM LENGTH CHROME VERSION = 2.00 m
TESTATE NON INCLUSE / DEAD ENDS NOT INCLUDED



zero75 — ugr<19

led integrato

integrated led

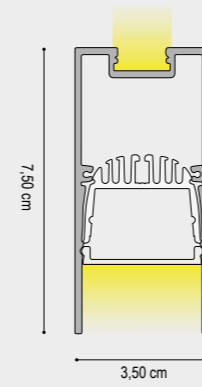

DATI TECNICI
TECHNICAL DATA

	1 cm - 2700K	1 cm - 3000K	1 cm - 4000K
Nominal LED Flux:	↑1440 lm/m - 3750 lm/m ↓	↑1440 lm/m - 3900 lm/m ↓	↑1440 lm/m - 4050 lm/m ↓
Flux Tot:	↑1296 lm/m - 3375 lm/m ↓	↑1296 lm/m - 3510 lm/m ↓	↑1296 lm/m - 3645 lm/m ↓
Output:	↑100 lm/W - 125 lm/W ↓	↑100 lm/W - 130 lm/W ↓	↑100 lm/W - 135 lm/W ↓
CCT:	2700 K	3000 K	4000 K
CRI:	>90	>90	>90
Power Tot:	45.0 W/m	45.0 W/m	45.0 W/m
Weight:	0.90 Kg/m	0.90 Kg/m	0.90 Kg/m
Profilo/Profile:	Alluminio/aluminum		Cover: Prismaticata/Prismatic Satinata/Satin

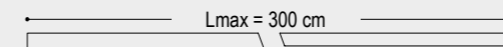

DRIVER NON INCLUSO / NOT INCLUDED

CAVO ALIMENTAZIONE: 50 cm
ALIMENTATION CABLE: 50 cm

FINITURA STRUTTURA
FINISHES

- GRIGIO VESUVIO ANTHRACITE
- ARGILLA CLAY
- ARGENTO OPACO/MATT SILVER
- BIANCO INTONACO/WHITE
- NERO CARAVAGGIO BLACK
- MOKA MOCHA
- CROMO CHROME
- ORO CALIFORNIA GOLD
- ARAMEN COPPER
- GRIGIO AVIO GREY AVIO
- ARGENTO COMETA/SILVER COMET
- OTTONE VENEZIANO BRASS
- TITANIO/TITANIUM
- BRONZO RIACI/RIACI BRONZE
- VERDE COSTA/GREEN COAST
- TERRA SENESE SENESE EARTH

DIFFUSORE
DIFFUSER

- SATINATA/SATIN
- PRISMATIZZATO
PRISMATIC

	1 cm - 2700K	1 cm - 3000K	1 cm - 4000K
CODICE CODE	75G8000301	75G8100301	75G8200301
	75G8001301	75G8101301	75G8201301
	75G8002301	75G8102301	75G8202301
	75G8003301	75G8103301	75G8203301
	75G8004301	75G8104301	75G8204301
	75G8005301	75G8105301	75G8205301
	75G8008301	75G8108301	75G8208301
	75G8009301	75G8109301	75G8209301
	75G8010301	75G8110301	75G8210301
	75G8011301	75G8111301	75G8211301
	75G8012301	75G8112301	75G8212301
	75G8013301	75G8113301	75G8213301
	75G8014301	75G8114301	75G8214301
	75G8015301	75G8115301	75G8215301
	75G8016301	75G8116301	75G8216301
	75G8017301	75G8117301	75G8217301

N.B./P.N.:
LUNGHEZZA MASSIMA VERSIONE CROMO = 2,00 m / MAXIMUM LENGTH CHROME VERSION = 2.00 m
TESTATE NON INCLUSE / DEAD ENDS NOT INCLUDED



TESTATE DI CHIUSURA / DEAD ENDS

FINITURA STRUTTURA FINISHES	CODICE CODE	FINITURA STRUTTURA FINISHES	CODICE CODE
GRIGIO VESUVIO ANTHRACITE	750400	ARAMEN COPPER	7504100
ARGILLA CLAY	750401	GRIGIO AVIO GREY AVIO	7504110
ARGENTO OPACO MATT SILVER	750402	ARGENTO COMETA/SILVER COMET	7504120
BIANCO INTONACO/WHITE	750403	OTTONE VENEZIANO BRASS	7504130
NERO CARAVAGGIO BLACK	750404	TITANIO/TITANIUM	7504140
MOKA MOCHA	750405	BRONZO RIACI/RIACI BRONZE	7504150
CROMO/CHROME	750408	VERDE COSTA/GREEN COAST	7504160
ORO CALIFORNIA/GOLD	750409	TERRA SENESE/SENESE EARTH	7504170

Nel codice sono comprese le viti per il fissaggio delle testate al profilo. Il codice contiene n° 1 testate di chiusura. / The code includes the screws for fixing the heads to the profile. The code contains 1 closing warheads

KIT DI SOSPENSIONE / SUSPENSION KIT

ARTICOLI INCLUSI NEL CODICE
ARTICLES INCLUDED IN THE CODE

Cavo in acciaio 2,00m con puntalino
2.00m steel cable with tip

Boccola cromata con regolazione millimetrica
Chrome bush with millimeter adjustment

Cavo in acciaio 3,00m con puntalino
3.00m steel cable with tip

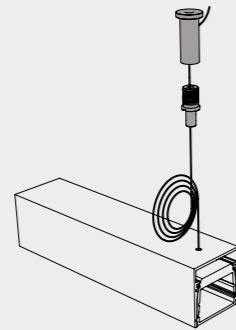

FINITURA
FINISHES

CODICE
CODE

CROMO/CHROME

1100508200

1100508F30

STAFFA DI FISSAGGIO A CARTONGESSO / MOUNTING CLIP FOR PLASTERBOARD

Accessorio che consente l'incasso del profilo.
Accessory that allows the collection of the profile

Nel codice sono comprese le viti per il fissaggio del
profilo alla staffa.
The code includes screws for fixing the profile to the bracket

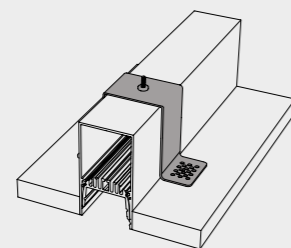

FINITURA
FINISHES

CODICE
CODE

ALLUMINIO NATURALE/ALUMINUM

750502

GIUNTI / JOINTS

GIUNTO LINEA CONTINUA / STRAIGHT JOINT

Accessorio per giunzioni meccaniche lineari
Accessory for linear mechanical joints

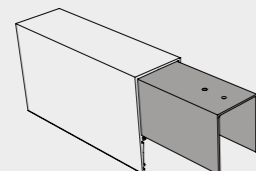

FINITURA
FINISHES

CODICE
CODE

ALLUMINIO NATURALE/ALUMINUM

75050601

GIUNTO 90° ORIZZONTALE / HORIZONTAL JOINT 90°

Accessorio per giunzioni meccaniche con angolo 90°
Accessory for linear mechanical joints with 90° angle

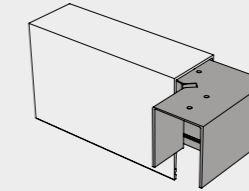

ALLUMINIO NATURALE/ALUMINUM

75050602

GIUNTO ANGOLARE A T / ANGULAR T-JOINT

Accessorio per giunzioni meccaniche a T
Accessory for mechanical T-junctions

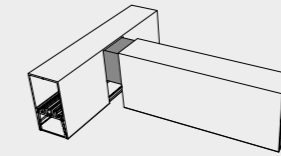

ALLUMINIO NATURALE/ALUMINUM

75050603

GIUNTO ANGOLARE A X / ANGULAR X-JOINT

Accessorio per giunzioni meccaniche a X
Accessory for mechanical X-junctions

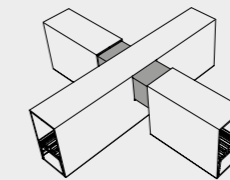

ALLUMINIO NATURALE/ALUMINUM

75050604

LAVORAZIONI / PROCESSING

DATI TECNICI
TECHNICAL DATA

CODICE
CODE

TAGLIO 90° ORIZZONTALE (PER ANGOLI FORMATI DA DUE PROFILI)
HORIZONTAL 90° CUT (FOR CORNERS MADE OF TWO PROFILES)

190X

TAGLIO 90° VERTICALE (PER ANGOLI FORMATI DA DUE PROFILI)
VERTICAL 90° CUT (FOR CORNERS MADE OF TWO PROFILES)

190Y

TAGLIO ANGOLARE CUSTOM (PER ANGOLI FORMATI DA DUE PROFILI)
CUSTOM CORNER CUT (FOR CORNERS MADE OF TWO PROFILES)

190N

ASOLA STANDARD 2X1CM / STANDARD SLOT 2X1CM

100A

ASOLA CUSTOMIZZATA / CUSTOM SLOT

100N

FORO / HOLE

100F

CABLAGGIO - COLLAUDO - CE LED AL CENTIMETRO
INSTALLATION AND TESTING LED MODULE AT CENTIMETER

1101

CONNETTORE MASCHIO/FEMMINA
MALE/FEMALE CONNECTOR

98CFM

CONNETTORE MASCHIO/FEMMINA MONTATO NEL PRODOTTO
MALE/FEMALE CONNECTOR FITTED IN THE PRODUCT

98MFM

CAVO DI ALIMENTAZIONE 2X0,75 TONDO TRASPARENTE 1CM
POWER CABLE 2X0,75 ROUND TRANSPARENT 1CM

98CTT001

MONTAGGIO CABLAGGIO COLLAUDO CE DRIVER 60W /
MOUNTING WIRING TESTING CE MARKING DRIVER 60W

1050A

MONTAGGIO CABLAGGIO COLLAUDO CE DRIVER 96W
/MOUNTING WIRING TESTING CE MARKING DRIVER 96W

1096A

MONTAGGIO CABLAGGIO COLLAUDO CE DRIVER DIM 70W /
MOUNTING WIRING TESTING CE MARKING DIM DRIVER 70W

1070D

MONTAGGIO CABLAGGIO COLLAUDO CE DRIVER DIM 100W /
MOUNTING WIRING TESTING CE MARKING DRIVER DIM 100W

1101D

**“tecnologia al top
per qualità, resa cromatica,
lumen emessi, temperatura colore”**

ZER035 costruito in estruso di alluminio si avvale della tecnologia degli schermi in policarbonato per diffondere la luce per mezzo di LED al top, per qualità, resa cromatica, lumen emessi, ed accurata selezione della temperatura colore, scelta in base al progetto scenografico che vogliamo ottenere. ZER035 offre una gamma di finiture e di accessori, i tagli lineari e a 45° o su MISURA, rendono realizzabile qualsiasi progetto sia esso da incasso a parete, plafone o sospensione.

ZER035 is made in extruded aluminium. Use polycarbonate technology for diffusing led light with high precision, use high quality like led, colour rendering, lumen output and accurate colour temperature for ensuring optimal results for each type of project. ZER035 offers a wide gamma of finishing's and accessories, several lengths, 45°cuts or completely customized. With Zer035 it's possible to realize any kind of projects like wall-recessed, surface mounting or pendant.

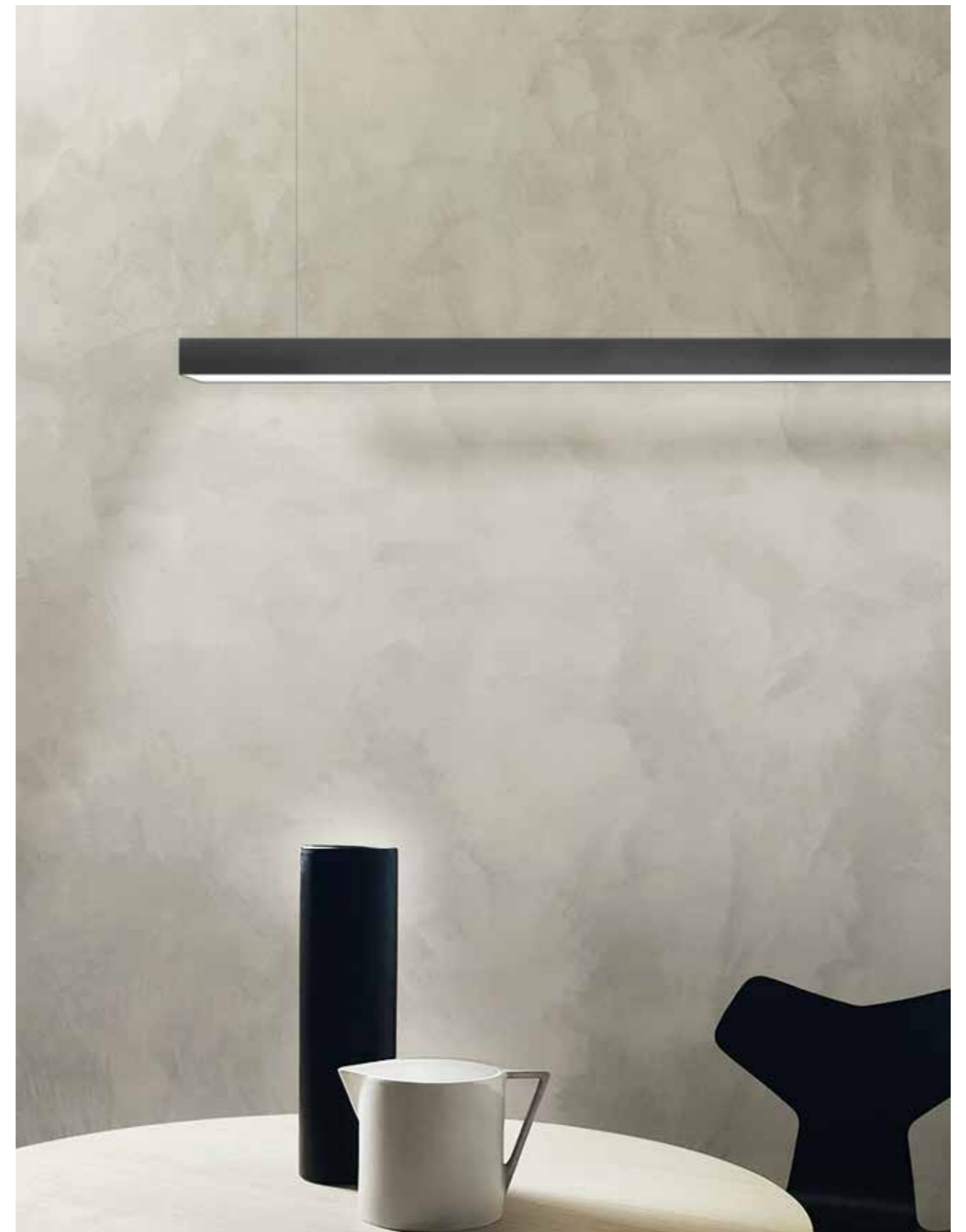

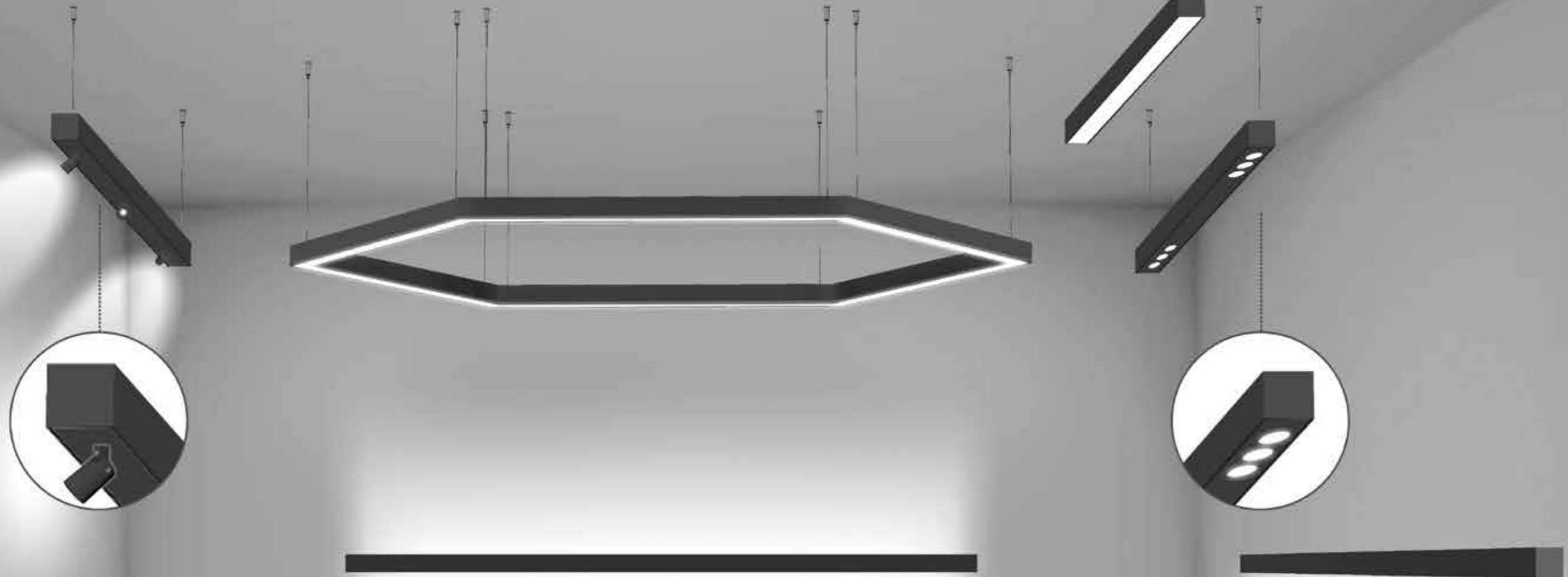

LE COMPOSIZIONI SOPRA RIPORTATE POSSONO ESSERE REALIZZATE PER INSTALLAZIONE A SOSPENSIONE / SOFFITTO-PARETE / INCASSO.
 PER LE COMPOSIZIONI POLIGONALI RIVOLGERSI AL NOSTRO REPARTO TECNICO.

THE ABOVE COMPOSITIONS CAN BE MADE FOR SUSPENSION / CEILING-WALL / RECESSED INSTALLATION.
 FOR POLYGONAL COMPOSITIONS, PLEASE CONTACT OUR TECHNICAL DEPARTMENT.

IL FISSAGGIO A SUPERFICIE NON PREVEDE UTILIZZO DI ACCESSORI. IL PRODOTTO ZERO35 SI INSTALLA A SUPERFICIE MEDIANTE UTILIZZO DI TASSELLI IDONEI AL TIPO DI MURATURA E FORANDO IL PROFILO ESTERNO IN ALLUMINIO. LA FORATURA DEL PROFILO PUÒ ESSERE RICHIESTA UTILIZZANDO IL CODICE 100F.

SURFACE MOUNTING DOES NOT INCLUDE THE USE OF ACCESSORIES. THE ZERO35 PRODUCT IS INSTALLED ON THE SURFACE BY USING DOWELS SUITABLE FOR THE TYPE OF MASONRY AND DRILLING THE EXTERNAL ALUMINUM PROFILE. PROFILE DRILLING CAN BE REQUIRED USING CODE 100F.

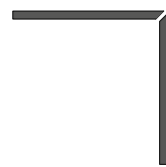

A. COMPOSIZIONE ANGOLARE A "L"
 A. L-ANGLE COMPOSITION

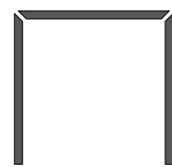

B. COMPOSIZIONE ANGOLARE A "C"
 B. C-ANGLE COMPOSITION

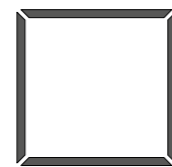

C. COMPOSIZIONE POLIGONALE (QUADRATO/RETTANGOLO)
 C. POLYGONAL COMPOSITION (SQUARE / RECTANGLE)



D. COMPOSIZIONE POLIGONALE (PENTAGONO/ESAGONO)
 D. POLYGONAL COMPOSITION (PENTAGON / HEX)

INSTALLAZIONE A SOSPENSIONE
 SUSPENSION

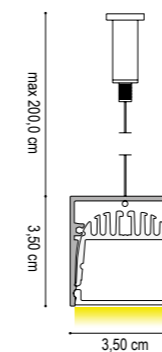

INSTALLAZIONE A SOFFITTO
 CEILING INSTALLATION

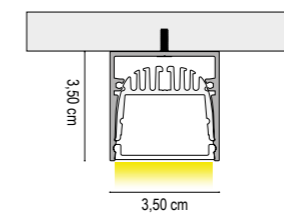

INSTALLAZIONE A INCASSO IN CARTONGESSO
 RECESSED INSTALLATION IN PLASTERBOARD

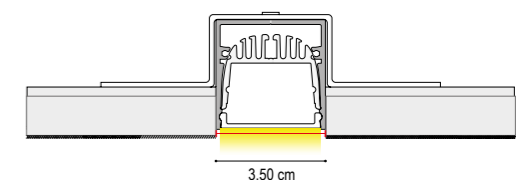

 **INSTALLAZIONE AD INCASSO**
 LARGHEZZA TAGLIO
 L=3,50 cm
 RECESSED INSTALLATION

ATTENZIONE! GLI ACCESSORI PER L'INSTALLAZIONE A INCASSO SONO STATI DIMENSIONATI PER UN PANNELLO STANDARD IN CARTONGESSO DI SPESSORE 12,5 mm
 WARNING! THE BUILT-IN INSTALLATION ACCESSORIES HAVE BEEN DIMENSIONED FOR A STANDARD PLASTERBOARD PANEL OF 12.5 mm THICKNESS

zero35

led integrato

integrated led

DATI TECNICI
TECHNICAL DATA

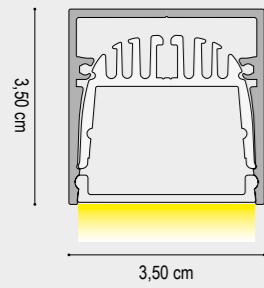

	1 cm	200 cm	300 cm
Nominal LED Flux:	2200 lm/m	4400 lm	6600 lm
Flux Tot:	1760 lm/m	3520 lm	5280 lm
Output:	105 lm/W	105 lm/W	105 lm/W
CCT:	3000 K	3000 K	3000 K
CRI:	>90	>90	>90
Power Tot:	20.0 W/m	40.0 W	60.0 W
Weight:	0.90 Kg/m	1.80 Kg	2.70 Kg

Profilo/Profile: Alluminio/aluminum Cover: Opale/opal

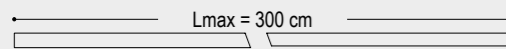

DRIVER NON INCLUSO / NOT INCLUDED

CAVO ALIMENTAZIONE: 50 cm
ALIMENTATION CABLE: 50 cm

zero35

led integrato

integrated led

DATI TECNICI
TECHNICAL DATA

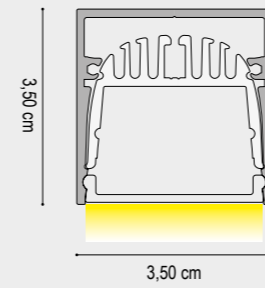

	1 cm
Nominal LED Flux:	2975 lm/m
Flux Tot:	2380 lm/m
Output:	125 lm/W
CCT:	3000 K
CRI:	>90
Power Tot:	23.0 W/m
Weight:	0.90 Kg/m

Profilo/Profile: Alluminio/aluminum Cover: Opale/opal

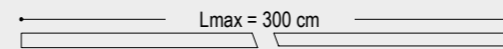

DRIVER NON INCLUSO / NOT INCLUDED

CAVO ALIMENTAZIONE: 50 cm
ALIMENTATION CABLE: 50 cm

FINITURA STRUTTURA FINISHES	DIFFUSORE DIFFUSER	1 cm CODICE CODE	200 cm CODICE CODE	300 cm CODICE CODE
GRIGIO VESUVIO ANTHRACITE	OPALE/OPAL	1104700001	1104700200	1104700300
ARGILLA CLAY		1104701001	1104701200	1104701300
ARGENTO OPACO/MATT SILVER		1104702001	1104702200	1104702300
BIANCO INTONACO/WHITE		1104703001	1104703200	1104703300
NERO CARAVAGGIO/BLACK		1104704001	1104704200	1104704300
MOKA MOCHA		1104705001	1104705200	1104705300
ORO CALIFORNIA/GOLD		1104709001	1104709200	1104709300
ARAMEN COPPER		1104710001	1104710200	1104710300
GRIGIO AVIO/GREY AVIO		1104711001	1104711200	1104711300
ARGENTO COMETA/SILVER COMET		1104712001	1104712200	1104712300
OTTONE VENEZIANO/BRASS		1104713001	1104713200	1104713300
TITANIO/TITANIUM		1104714001	1104714200	1104714300
BRONZO RIACI/RIACI BRONZE		1104715001	1104715200	1104715300
VERDE COSTA/GREEN COAST		1104716001	1104716200	1104716300
TERRA SENESE/SENESE EARTH		1104717001	1104717200	1104717300
CROMO/CHROME		1104708001	1104708200	

N.B./P.N.:
LUNGHEZZA MASSIMA VERSIONE CROMO = 2,00 m / MAXIMUM LENGTH CHROME VERSION = 2.00 m
TESTATE NON INCLUSE / DEAD ENDS NOT INCLUDED

FINITURA STRUTTURA FINISHES	DIFFUSORE DIFFUSER	1 cm - 2700K CODICE CODE	1 cm - 3000K CODICE CODE	1 cm - 4000K CODICE CODE
GRIGIO VESUVIO ANTHRACITE	OPALE/OPAL	110H600001	110H700001	110H800001
ARGILLA CLAY		110H601001	110H701001	110H801001
ARGENTO OPACO/MATT SILVER		110H602001	110H702001	110H802001
BIANCO INTONACO/WHITE		110H603001	110H703001	110H803001
NERO CARAVAGGIO/BLACK		110H604001	110H704001	110H804001
MOKA MOCHA		110H605001	110H705001	110H805001
CROMO/CHROME		110H608001	110H708001	110H808001
ORO CALIFORNIA/GOLD		110H609001	110H709001	110H809001
ARAMEN COPPER		110H610001	110H710001	110H810001
GRIGIO AVIO/GREY AVIO		110H611001	110H711001	110H811001
ARGENTO COMETA/SILVER COMET		110H612001	110H712001	110H812001
OTTONE VENEZIANO/BRASS		110H613001	110H713001	110H813001
TITANIO/TITANIUM		110H614001	110H714001	110H814001
BRONZO RIACI/RIACI BRONZE		110H615001	110H715001	110H815001
VERDE COSTA/GREEN COAST		110H616001	110H716001	110H816001
TERRA SENESE/SENESE EARTH		110H617001	110H717001	110H817001

N.B./P.N.:
LUNGHEZZA MASSIMA VERSIONE CROMO = 2,00 m / MAXIMUM LENGTH CHROME VERSION = 2.00 m
TESTATE NON INCLUSE / DEAD ENDS NOT INCLUDED

zero35

led integrato

integrated led

DATI TECNICI
TECHNICAL DATA

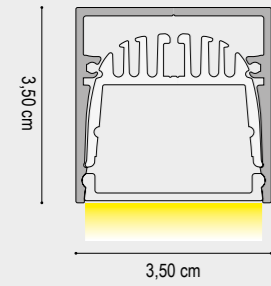

	1 cm	200 cm	300 cm
Nominal LED Flux:	4440 lm/m	8880 lm	13320 lm
Flux Tot:	3552 lm/m	7104 lm	10656 lm
Output:	148 lm/W	148 lm/W	148 lm/W
CCT:	3000 K	3000 K	3000 K
CRI:	>90	>90	>90
Power Tot:	30.0 W/m	60.0 W	90.0 W
Weight:	0.90 Kg/m	1.80 Kg	2.70 Kg

Profilo/Profile: Alluminio/aluminum Cover: Opale/opal

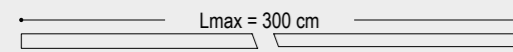

DRIVER NON INCLUSO / NOT INCLUDED

CAVO ALIMENTAZIONE: 50 cm
ALIMENTATION CABLE: 50 cm

zero35 — ugr<19

led integrato

integrated led

DATI TECNICI
TECHNICAL DATA

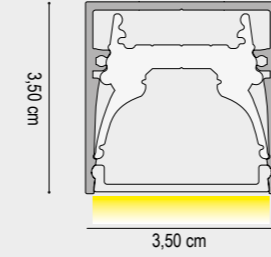

	1 cm	200 cm	300 cm
Nominal LED Flux:	4440 lm/m	8880 lm	13320 lm
Flux Tot:	3552 lm/m	7104 lm	10656 lm
Output:	148 lm/W	148 lm/W	148 lm/W
CCT:	3000 K	3000 K	3000 K
CRI:	>90	>90	>90
Power Tot:	30.0 W/m	60.0 W	90.0 W
Weight:	0.90 Kg/m	1.80 Kg	2.70 Kg

Profilo/Profile: Alluminio/aluminum Cover: Prismatizzato/prismatic

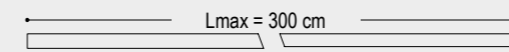

DRIVER NON INCLUSO / NOT INCLUDED

CAVO ALIMENTAZIONE: 50 cm
ALIMENTATION CABLE: 50 cm

FINITURA STRUTTURA FINISHES	DIFFUSORE DIFFUSER	1 cm CODICE CODE	200 cm CODICE CODE	300 cm CODICE CODE
GRIGIO VESUVIO ANTHRACITE	OPALE/OPAL	110810001	1108100200	1108100300
ARGILLA CLAY		1108101001	1108101200	1108101300
ARGENTO OPACO/MATT SILVER		1108102001	1108102200	1108102300
BIANCO INTONACO/WHITE		1108103001	1108103200	1108103300
NERO CARAVAGGIO BLACK		1108104001	1108104200	1108104300
MOKA MOCHA		1108105001	1108105200	1108105300
ORO CALIFORNIA/GOLD		1108109001	1108109200	1108109300
ARAMEN COPPER		1108110001	1108110200	1108110300
GRIGIO AVIO/GREY AVIO		1108111001	1108111200	1108111300
ARGENTO COMETA/SILVER COMET		1108112001	1108112200	1108112300
OTTONE VENEZIANO BRASS		1108113001	1108113200	1108113300
TITANIO/TITANIUM		1108114001	1108114200	1108114300
BRONZO RIACI/RIACI BRONZE		1108115001	1108115200	1108115300
VERDE COSTA/GREEN COAST		1108116001	1108116200	1108116300
TERRA SENESE SENESE EARTH		1108117001	1108117200	1108117300
CROMO CHROME		1108108001	1108108200	

N.B./P.N.:

LUNGHEZZA MASSIMA VERSIONE CROMO = 2,00 m / MAXIMUM LENGTH CHROME VERSION = 2.00 m
TESTATE NON INCLUSE / DEAD ENDS NOT INCLUDED

FINITURA STRUTTURA FINISHES	DIFFUSORE DIFFUSER	1 cm CODICE CODE	200 cm CODICE CODE	300 cm CODICE CODE
GRIGIO VESUVIO ANTHRACITE	PRISMATIZZATO PRISMATIC	1108100031	1108100230	1108100330
ARGILLA CLAY		1108101031	1108101230	1108101330
ARGENTO OPACO/MATT SILVER		1108102031	1108102230	1108102330
BIANCO INTONACO/WHITE		1108103031	1108103230	1108103330
NERO CARAVAGGIO BLACK		1108104031	1108104230	1108104330
MOKA MOCHA		1108105031	1108105230	1108105330
ORO CALIFORNIA/GOLD		1108109031	1108109230	1108109330
ARAMEN COPPER		1108110031	1108110230	1108110330
GRIGIO AVIO/GREY AVIO		1108111031	1108111230	1108111330
ARGENTO COMETA/SILVER COMET		1108112031	1108112230	1108112330
OTTONE VENEZIANO BRASS		1108113031	1108113230	1108113330
TITANIO/TITANIUM		1108114031	1108114230	1108114330
BRONZO RIACI/RIACI BRONZE		1108115031	1108115230	1108115330
VERDE COSTA/GREEN COAST		1108116031	1108116230	1108116330
TERRA SENESE SENESE EARTH		1108117031	1108117230	1108117330
CROMO CHROME		1108108031	1108108230	

N.B./P.N.:

LUNGHEZZA MASSIMA VERSIONE CROMO = 2,00 m / MAXIMUM LENGTH CHROME VERSION = 2.00 m
TESTATE NON INCLUSE / DEAD ENDS NOT INCLUDED

zero35 square

led integrato

integrated led

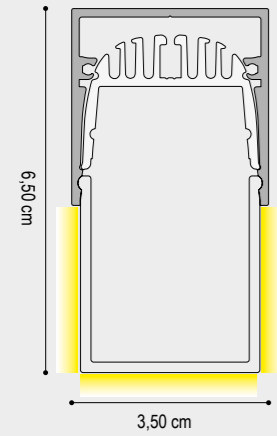

DATI TECNICI
TECHNICAL DATA

	1 cm	200 cm	300 cm
Nominal LED Flux:	2975 lm/m	5950 lm	8925 lm
Flux Tot:	2380 lm/m	4760 lm	7140 lm
Output:	125 lm/W	125 lm/W	125 lm/W
CCT:	3000 K	3000 K	3000 K
CRI:	>90	>90	>90
Power Tot:	23.0 W/m	46.0 W	69.0 W
Weight:	0.90 Kg/m	1.80 Kg	2.70 Kg

Profilo/Profile: Alluminio/aluminum

Cover: Opale/opal

Lmax = 300 cm

DRIVER NON INCLUSO / NOT INCLUDED

CAVO ALIMENTAZIONE: 50 cm
ALIMENTATION CABLE: 50 cm

FINITURA STRUTTURA
FINISHES

- GRIGIO VESUVIO ANTHRACITE
- ARGILLA CLAY
- ARGENTO OPACO MATT SILVER
- BIANCO INTONACO/WHITE
- NERO CARAVAGGIO BLACK
- MOKA MOCHA
- CROMO/CHROME
- ORO CALIFORNIA GOLD
- ARAMEN COPPER
- GRIGIO AVIO GREY AVIO
- ARGENTO COMETA/SILVER COMET
- OTTONE VENEZIANO BRASS
- TITANIO/TITANIUM
- BRONZO RIACI/RIACI BRONZE
- VERDE COSTA/GREEN COAST
- TERRA SENESE SENESE EARTH

DIFFUSORE
DIFFUSER

OPALE/OPAL

	1 cm - 2700K	1 cm - 3000K	1 cm - 4000K
CODICE CODE	110H600701	110H700701	110H800701
	110H601701	110H701701	110H801701
	110H602701	110H702701	110H802701
	110H603701	110H703701	110H803701
	110H604701	110H704701	110H804701
	110H605701	110H705701	110H805701
	110H608701	110H708701	110H808701
	110H609701	110H709701	110H809701
	110H610701	110H710701	110H810701
	110H611701	110H711701	110H811701
	110H612701	110H712701	110H812701
	110H613701	110H713701	110H813701
	110H614701	110H714701	110H814701
	110H615701	110H715701	110H815701
	110H616701	110H716701	110H816701
	110H617701	110H717701	110H817701

N.B./P.N.:

LUNGHEZZA MASSIMA VERSIONE CROMO = 2,00 m / MAXIMUM LENGTH CHROME VERSION = 2.00 m
TESTATE NON INCLUSE / DEAD ENDS NOT INCLUDED

zero35 square

led integrato

integrated led

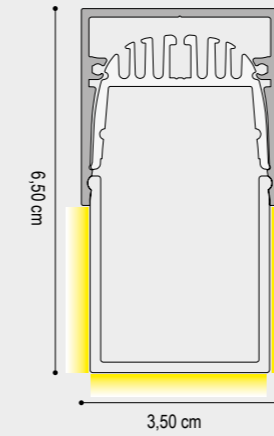

DATI TECNICI
TECHNICAL DATA

	1 cm	200 cm	300 cm
Nominal LED Flux:	4440 lm/m	8880 lm	13320 lm
Flux Tot:	3552 lm/m	7104 lm	10656 lm
Output:	148 lm/W	148 lm/W	148 lm/W
CCT:	3000 K	3000 K	3000 K
CRI:	>90	>90	>90
Power Tot:	30.0 W/m	60.0 W	90.0 W
Weight:	0.90 Kg/m	1.80 Kg	2.70 Kg

Profilo/Profile: Alluminio/aluminum

Cover: Opale/opal

Lmax = 300 cm

DRIVER NON INCLUSO / NOT INCLUDED

CAVO ALIMENTAZIONE: 50 cm
ALIMENTATION CABLE: 50 cm

FINITURA STRUTTURA
FINISHES

- GRIGIO VESUVIO ANTHRACITE
- ARGILLA CLAY
- ARGENTO OPACO MATT SILVER
- BIANCO INTONACO/WHITE
- NERO CARAVAGGIO BLACK
- MOKA MOCHA
- ORO CALIFORNIA GOLD
- ARAMEN COPPER
- GRIGIO AVIO GREY AVIO
- ARGENTO COMETA/SILVER COMET
- OTTONE VENEZIANO BRASS
- TITANIO/TITANIUM
- BRONZO RIACI/RIACI BRONZE
- VERDE COSTA/GREEN COAST
- TERRA SENESE SENESE EARTH
- CROMO/CHROME

DIFFUSORE
DIFFUSER

OPALE/OPAL

	1 cm	200 cm	300 cm
CODICE CODE	1108100701	1108100720	1108100730
	1108101701	1108101720	1108101730
	1108102701	1108102720	1108102730
	1108103701	1108103720	1108103730
	1108104701	1108104720	1108104730
	1108105701	1108105720	1108105730
	1108109701	1108109720	1108109730
	1108110701	1108110720	1108110730
	1108111701	1108111720	1108111730
	1108112701	1108112720	1108112730
	1108113701	1108113720	1108113730
	1108114701	1108114720	1108114730
	1108115701	1108115720	1108115730
	1108116701	1108116720	1108116730
	1108117701	1108117720	1108117730
	1108108701	1108108720	

N.B./P.N.:

LUNGHEZZA MASSIMA VERSIONE CROMO = 2,00 m / MAXIMUM LENGTH CHROME VERSION = 2.00 m
TESTATE NON INCLUSE / DEAD ENDS NOT INCLUDED

TESTATE DI CHIUSURA SQUARE / SQUARE DEAD ENDS

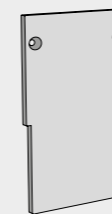

FINITURA STRUTTURA FINISHES	CODICE CODE	FINITURA STRUTTURA FINISHES	CODICE CODE
GRIGIO VESUVIO ANTHRACITE	1100800	ARAMEN COPPER	1100810
ARGILLA CLAY	1100801	GRIGIO AVIO GREY AVIO	1100811
ARGENTO OPACO MATT SILVER	1100802	ARGENTO COMETA/SILVER COMET	1100812
BIANCO INTONACO/WHITE	1100803	OTTONE VENEZIANO BRASS	1100813
NERO CARAVAGGIO BLACK	1100804	TITANIO/TITANIUM	1100814
MOKA MOCHA	1100805	BRONZO RIACI/RIACI BRONZE	1100815
CROMO/CHROME	1100808	VERDE COSTA/GREEN COAST	1100816
ORO CALIFORNIA GOLD	1100809	TERRA SENESE SENESE EARTH	1100817

Nel codice sono comprese le viti per il fissaggio delle testate al profilo. Il codice contiene n° 1 testate di chiusura. / The code includes the screws for fixing the heads to the profile. The code contains 1 closing warheads



zero35

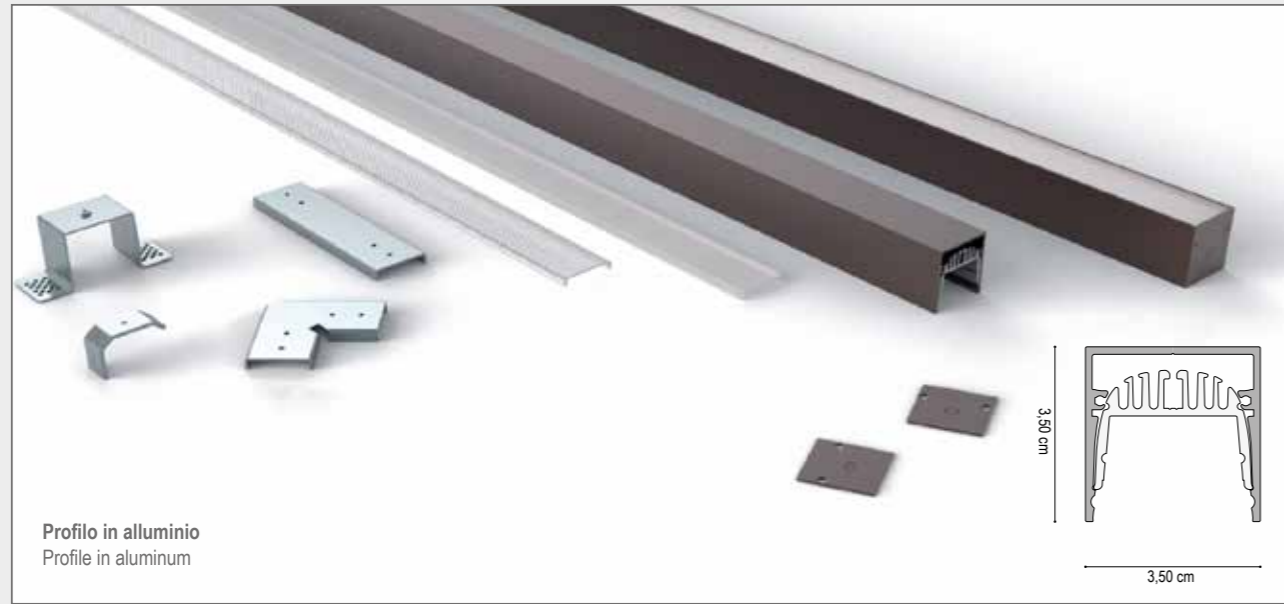

Profilo in alluminio
Profile in aluminum

**FINITURA STRUTTURA
FINISHES**

- GRIGIO VESUVIO ANTHRACITE
- ARGILLA CLAY
- ARGENTO OPACO MATT SILVER
- BIANCO INTONACO/WHITE
- NERO CARAVAGGIO BLACK
- MOKA MOCHA
- ORO CALIFORNIA GOLD
- ARAMEN COPPER
- GRIGIO AVIO GREY AVIO
- ARGENTO COMETA/SILVER COMET
- OTTONE VENEZIANO BRASS
- TITANIO/TITANIUM
- BRONZO RIACI/RIACI BRONZE
- VERDE COSTA/GREEN COAST
- TERRA SENESE SENESE EARTH
- CROMO CHROME

	1 cm	200 cm	300 cm
CODICE CODE	CODICE CODE	CODICE CODE	CODICE CODE
1100300001	1100300200	1100300300	
1100301001	1100301200	1100301300	
1100302001	1100302200	1100302300	
1100303001	1100303200	1100303300	
1100304001	1100304200	1100304300	
1100305001	1100305200	1100305300	
1100309001	1100309200	1100309300	
1100310001	1100310200	1100310300	
1100311001	1100311200	1100311300	
1100312001	1100312200	1100312300	
1100313001	1100313200	1100313300	
1100314001	1100314200	1100314300	
1100315001	1100315200	1100315300	
1100316001	1100316200	1100316300	
1100317001	1100317200	1100317300	
1100308001	1100308200		

N.B./P.N.:

LUNGHEZZA MASSIMA VERSIONE CROMO = 2,00 m / MAXIMUM LENGTH CHROME VERSION = 2.00 m
TESTATE NON INCLUDE / DEAD ENDS NOT INCLUDED

LED compatibili / LED compatibility

HIGH QUALITY CRI>90 CRI>95	HIGH OUTPUT CRI>90 CRI>95	HIGH EFFICIENT CRI>90 CRI>95	HIGH INTENSITY CRI>90 CRI>95	LOW POWER CRI>90	ULTRA SLIM CRI>90 CRI>95 CRI>97	RGB	RGB WHITE	RGB TW	TUNABLE WHITE
9,6W 14,4W 19,2W	12,3W 14,4W 19,2W 20W 24W	12,3W 14,4W 19,2W 20W 24W	24W 24W (700 LED)	6W	9,6W 12W 14,4W	14W	14W	14,4W 23W	19,2W

zero35

diffusore

cover

	1 cm	200 cm	300 cm
DIFFUSORE DIFFUSER	CODICE CODE	CODICE CODE	CODICE CODE
OPALE/OPAL	1100100001	1100100200	1100100300
SATINATA/SATIN	1100101001	1100101200	1100101300
PRISMATIZZATO PRISMATIC	1100103001	1100103200	1100103300
10 mt			
DIFFUSORE DIFFUSER	CODICE CODE		
PRISMATIZZATO PRISMATIC	1100103999		

zero35

alluminio cover

aluminum cover

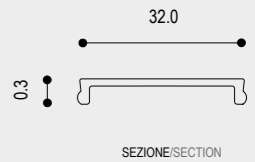

	1 cm		1 cm
FINITURA STRUTTURA FINISHES	CODICE CODE	FINITURA STRUTTURA FINISHES	CODICE CODE
GRIGIO VESUVIO ANTHRACITE	1100500001	ARAMEN COPPER	1100510001
ARGILLA CLAY	1100501001	GRIGIO AVIO GREY AVIO	1100511001
ARGENTO OPACO MATT SILVER	1100502001	ARGENTO COMETA/SILVER COMET	1100512001
BIANCO INTONACO/WHITE	1100503001	OTTONE VENEZIANO BRASS	1100513001
NERO CARAVAGGIO BLACK	1100504001	TITANIO/TITANIUM	1100514001
MOKA MOCHA	1100505001	BRONZO RIACI/RIACI BRONZE	1100515001
CROMO CHROME	1100508001	VERDE COSTA/GREEN COAST	1100516001
ORO CALIFORNIA GOLD	1100509001	TERRA SENESE SENESE EARTH	1100517001

TESTATE DI CHIUSURA / DEAD ENDS

FINITURA STRUTTURA FINISHES	CODICE CODE	FINITURA STRUTTURA FINISHES	CODICE CODE
GRIGIO VESUVIO ANTHRACITE	1100400000	ARAMEN COPPER	1100410000
ARGILLA CLAY	1100401000	GRIGIO AVIO GREY AVIO	1100411000
ARGENTO OPACO MATT SILVER	1100402000	ARGENTO COMETA/SILVER COMET	1100412000
BIANCO INTONACO/WHITE	1100403000	OTTONE VENEZIANO BRASS	1100413000
NERO CARAVAGGIO BLACK	1100404000	TITANIO/TITANIUM	1100414000
MOKA MOCHA	1100405000	BRONZO RIACI/RIACI BRONZE	1100415000
CROMO/CHROME	1100408000	VERDE COSTA/GREEN COAST	1100416000
ORO CALIFORNIA/GOLD	1100409000	TERRA SENESE SENESE EARTH	1100417000

Nel codice sono comprese le viti per il fissaggio delle testate al profilo. Il codice contiene n° 1 testate di chiusura. / The code includes the screws for fixing the heads to the profile. The code contains 1 closing warheads

TESTATE DI CHIUSURA CON LOGO / DEAD ENDS WITH LOGO

FINITURA STRUTTURA FINISHES	CODICE CODE	FINITURA STRUTTURA FINISHES	CODICE CODE
GRIGIO VESUVIO ANTHRACITE	1100600000	GRIGIO AVIO GREY AVIO	1100611000
ARGILLA CLAY	1100601000	ARGENTO COMETA/SILVER COMET	1100612000
BIANCO INTONACO/WHITE	1100603000	OTTONE VENEZIANO BRASS	1100613000
NERO CARAVAGGIO BLACK	1100604000	TITANIO/TITANIUM	1100614000
MOKA MOCHA	1100605000	BRONZO RIACI/RIACI BRONZE	1100615000
CROMO/CHROME	1100608000	VERDE COSTA/GREEN COAST	1100616000
ORO CALIFORNIA/GOLD	1100609000	TERRA SENESE SENESE EARTH	1100617000
ARAMEN COPPER	1100610000		

Nel codice sono comprese le viti per il fissaggio delle testate al profilo. Il codice contiene n° 1 testate di chiusura. / The code includes the screws for fixing the heads to the profile. The code contains 1 closing warheads

KIT DI SOSPENSIONE / SUSPENSION KIT

ARTICOLI INCLUSI NEL CODICE ARTICLES INCLUDED IN THE CODE	FINITURA FINISHES	CODICE CODE
Cavo in acciaio 2,00 m con puntalino 2.00m steel cable with tip Boccola cromata con regolazione millimetrica Chrome bush with millimeter adjustment	CROMO/CHROME	1100508200
Cavo in acciaio 3,00 m con puntalino 3.00m steel cable with tip		1100508F30

STAFFA DI FISSAGGIO A CARTONGESSO / MOUNTING CLIP FOR PLASTERBOARD

Accessorio che consente l'incasso del profilo. Accessory that allows the collection of the profile	FINITURA FINISHES	CODICE CODE
Nel codice sono comprese le viti per il fissaggio del profilo alla staffa. The code includes screws for fixing the profile to the bracket	ALLUMINIO NATURALE/ALUMINUM	1100500002

GIUNTI / JOINTS

	FINITURA FINISHES	CODICE CODE
GIUNTO LINEA CONTINUA / STRAIGHT JOINT Accessorio per giunzioni meccaniche lineari Accessory for linear mechanical joints	ALLUMINIO NATURALE/ALUMINUM	1100506001
GIUNTO 90° ORIZZONTALE / HORIZONTAL JOINT 90° Accessorio per giunzioni meccaniche con angolo 90° Accessory for linear mechanical joints with 90° angle	ALLUMINIO NATURALE/ALUMINUM	1100506002
GIUNTO 90° VERTICALE INTERNO / VERTICAL JOINT 90° Accessorio per giunzioni meccaniche con angolo 90° Accessory for linear mechanical joints with 90° angle	ALLUMINIO NATURALE/ALUMINUM	1100506003
GIUNTO 90° VERTICALE ESTERNO / VERTICAL JOINT 90° Accessorio per giunzioni meccaniche con angolo 90° Accessory for linear mechanical joints with 90° angle	ALLUMINIO NATURALE/ALUMINUM	1100506004
GIUNTO ANGOLARE A T / ANGULAR T-JOINT Accessorio per giunzioni meccaniche a T Accessory for mechanical T-junctions	ALLUMINIO NATURALE/ALUMINUM	1100506006
GIUNTO ANGOLARE A X / ANGULAR T-JOINT Accessorio per giunzioni meccaniche a X Accessory for mechanical T-junctions	ALLUMINIO NATURALE/ALUMINUM	1100506007

Nel codice sono compresi i grani per il fissaggio del giunto / The code includes the grains for fixing the joint.

LAVORAZIONI / PROCESSING

DATI TECNICI TECHNICAL DATA	CODICE CODE
TAGLIO 90° ORIZZONTALE (PER ANGOLI FORMATI DA DUE PROFILI) HORIZONTAL 90 ° CUT (FOR CORNERS MADE OF TWO PROFILES)	190X
TAGLIO 90° VERTICALE (PER ANGOLI FORMATI DA DUE PROFILI) VERTICAL 90 ° CUT (FOR CORNERS MADE OF TWO PROFILES)	190Y
TAGLIO ANGOLARE CUSTOM (PER ANGOLI FORMATI DA DUE PROFILI) CUSTOM CORNER CUT (FOR CORNERS MADE OF TWO PROFILES)	190N
ASOLA STANDARD 2X1CM / STANDARD SLOT 2X1CM	100A
ASOLA CUSTOMIZZATA / CUSTOM SLOT	100N
FORO / HOLE	100F
CABLAGGIO - COLLAUDO - CE LED AL CENTIMETRO INSTALLATION AND TESTING LED MODULE AT CENTIMETER	1101
CONNETTORE MASCHIO/FEMMINA MALE/FEMALE CONNECTOR	98CFM
CONNETTORE MASCHIO/FEMMINA MONTATO NEL PRODOTTO MALE/FEMALE CONNECTOR FITTED IN THE PRODUCT	98MFM
CAVO DI ALIMENTAZIONE 2X0,75 TONDO TRASPARENTE 1CM POWER CABLE 2X0,75 ROUND TRANSPARENT 1CM	98CTT001

**“rende realizzabile
qualsiasi progetto a parete”**

ZER035-P costruito in estruso di alluminio si avvale della tecnologia degli schermi in policarbonato per diffondere la luce per mezzo di LED al top, per qualità, resa cromatica, lumen emessi, ed accurata selezione della temperatura colore, scelta in base al progetto scenografico che vogliamo ottenere. ZER035-P offre una gamma di finiture e di accessori, i tagli lineari e a 45° o su MISURA, rendono realizzabile qualsiasi progetto a parete.

ZER035-P is made in extruded aluminium. Use polycarbonate technology for diffusing led light with high precision, use high quality like led, colour rendering, lumen output and accurate colour temperature for ensuring optimal results for each type of project. ZER035-P offers a wide gamma of finishing's and accessories, several lengths, 45°cuts or completely customized.



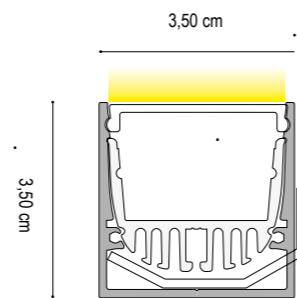
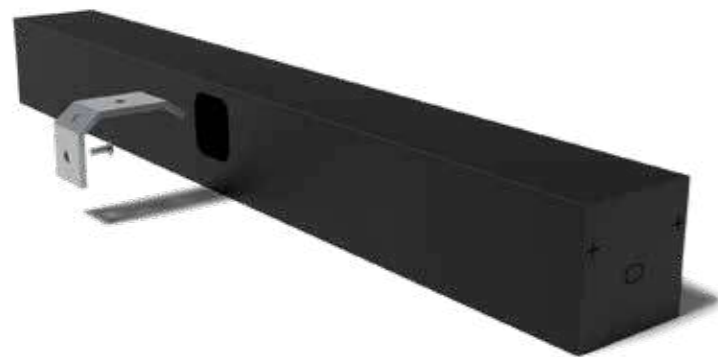

A RICHIESTA DISPONIBILE VERSIONE LUCE INDIRECTA /
INDIRECT LIGHT VERSION AVAILABLE ON REQUEST /

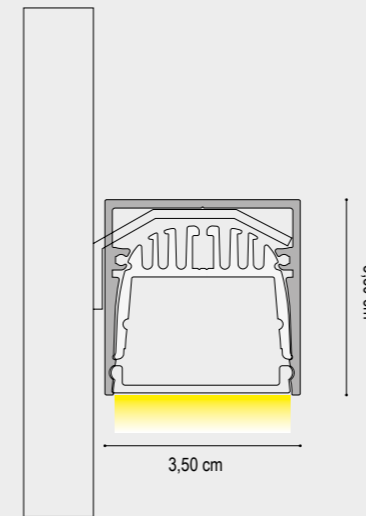

A. COMPOSIZIONE ANGOLARE A "L"
A. L-ANGLE COMPOSITION

B. COMPOSIZIONE ANGOLARE A "C"
B. C-ANGLE COMPOSITION

C. COMPOSIZIONE POLIGONALE
(QUADRATO/RETTANGOLO)
C. POLYGONAL COMPOSITION
(SQUARE / RECTANGLE)

INSTALLAZIONE STAFFA A PARETE
WALL BRACKET INSTALLATION

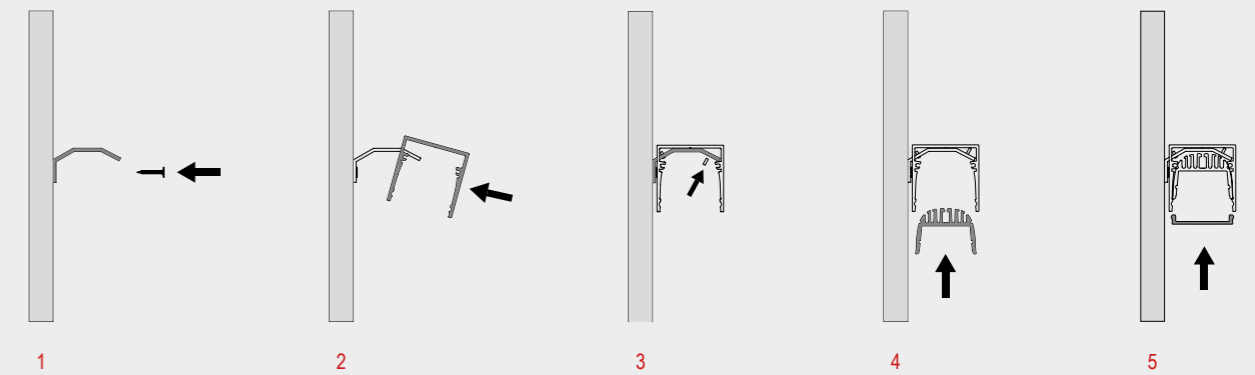

1. FISSARE LE STAFFE UTILIZZANDO SISTEMI DI FISSAGGIO IDONEI AL TIPO DI PARETE. PRESTARE ATTENZIONE ALL'ALINEAMENTO DELLE STAFFE PER UNA CORRETTA INSTALLAZIONE DEL PRODOTTO. IN CASO DI INSTALLAZIONE SU PARETE NON LINEARE, SI CONSIGLIA DI UTILIZZARE SUPPORTI DISTANZIALI AL FINE DI EVITARNE LA TORSIONE.
1. FIX THE BRACKETS USING FASTENING SYSTEMS SUITABLE FOR THE TYPE OF WALL. PAY ATTENTION TO THE ALIGNMENT OF THE BRACKETS FOR A CORRECT INSTALLATION OF THE PRODUCT. IN THE EVENT OF INSTALLATION ON A NON-LINEAR WALL, IT IS RECOMMENDED TO USE SPACER SUPPORTS IN ORDER TO AVOID TORSION.
2. SUL LATO DEL PROFILO RIVOLTO VERSO LA PARETE È PRESENTE UN'ASOLA. INSERIRE LA STAFFA NELL'ASOLA.
2. THERE IS A SLOT ON THE SIDE OF THE PROFILE FACING THE WALL. INSERT THE BRACKET IN THE SLOT.
3. BLOCCARE IL PROFILO ALLA STAFFA UTILIZZANDO GLI APPOSITI GRANI FILETTATI.
3. LOCK THE PROFILE TO THE BRACKET USING THE SPECIAL THREADED DOWELS.
4. INSERIRE IL DISSIPATORE IN ALLUMINIO. ATTENZIONE! ASSICURARSI DEL PERFETTO SCATTO TRA IL DISSIPATORE E IL PROFILO. UN'INSTALLAZIONE ERRATA PUÒ COMPROMETTERE LA TENUTA E LA DURABILITÀ DEL PRODOTTO.
4. INSERT THE ALUMINUM HEAT SINK. WARNING! MAKE SURE THE PERFECT SNAP BETWEEN THE HEAT SINK AND THE PROFILE. AN INCORRECT INSTALLATION MAY COMPROMISE THE SEALING AND DURABILITY OF THE PRODUCT.
5. INSERIRE LA COVER IN POLICARBONATO.
5. INSERT THE POLYCARBONATE COVER.

zero35 - p

led integrato

integrated led

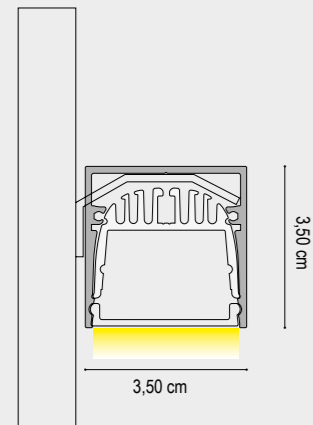

DATI TECNICI
TECHNICAL DATA

	1 cm	200 cm	300 cm
Nominal LED Flux:	2200 lm/m	4400 lm	6600 lm
Flux Tot:	1760 lm/m	3520 lm	5280 lm
Output:	105 lm/W	105 lm/W	105 lm/W
CCT:	3000 K	3000 K	3000 K
CRI:	>90	>90	>90
Power Tot:	20.0 W/m	40.0 W	60.0 W
Weight:	0.90 Kg/m	1.80 Kg	2.70 Kg

Profilo/Profile: Alluminio/aluminum

Cover: Opale/opal

DRIVER NON INCLUSO / NOT INCLUDED

STAFFE DI FISSAGGIO A PARETE INCLUSE NEL CODICE
WALL MOUNTING BRACKETS INCLUDED IN THE CODE

CAVO ALIMENTAZIONE: 50 cm
ALIMENTATION CABLE: 50 cm

FINITURA STRUTTURA FINISHES	DIFFUSORE DIFFUSER	1 cm CODICE CODE	200 cm CODICE CODE	300 cm CODICE CODE
GRIGIO VESUVIO ANTHRACITE	OPALE/OPAL	1104700021	1104700220	1104700320
ARGILLA CLAY		1104701021	1104701220	1104701320
ARGENTO OPACO/MATT SILVER		1104702021	1104702220	1104702320
BIANCO INTONACO/WHITE		1104703021	1104703220	1104703320
NERO CARAVAGGIO/BLACK		1104704021	1104704220	1104704320
MOKA MOCHA		1104705021	1104705220	1104705320
ORO CALIFORNIA/GOLD		1104709021	1104709220	1104709320
ARAMEN COPPER		1104710021	1104710220	1104710320
GRIGIO AVIO/GREY AVIO		1104711021	1104711220	1104711320
ARGENTO COMETA/SILVER COMET		1104712021	1104712220	1104712320
OTTONE VENEZIANO/BRASS		1104713021	1104713220	1104713320
TITANIO/TITANIUM		1104714021	1104714220	1104714320
BRONZO RIACI/RIACI BRONZE		1104715021	1104715220	1104715320
VERDE COSTA/GREEN COAST		1104716021	1104716220	1104716320
TERRA SENESE/SENESE EARTH		1104717021	1104717220	1104717320
CROMO/CHROME		1104708021	1104708220	

N.B./P.N.:

LUNGHEZZA MASSIMA VERSIONE CROMO = 2,00 m / MAXIMUM LENGTH CHROME VERSION = 2.00 m
TESTATE NON INCLUSE / DEAD ENDS NOT INCLUDED



zero35 - p

led integrato

integrated led

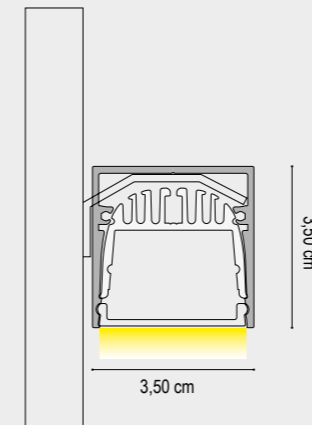

DATI TECNICI
TECHNICAL DATA

	1 cm
Nominal LED Flux:	2975 lm/m
Flux Tot:	2380 lm/m
Output:	125 lm/W
CCT:	3000 K
CRI:	>90
Power Tot:	23.0 W/m
Weight:	0.90 Kg/m

Profilo/Profile: Alluminio/aluminum
Cover: Opale/opal

DRIVER NON INCLUSO / NOT INCLUDED

STAFFE DI FISSAGGIO A PARETE INCLUSE NEL CODICE
WALL MOUNTING BRACKETS INCLUDED IN THE CODE

CAVO ALIMENTAZIONE: 50 cm
ALIMENTATION CABLE: 50 cm

FINITURA STRUTTURA FINISHES	DIFFUSORE DIFFUSER	1 cm - 2700K CODICE CODE	1 cm - 3000K CODICE CODE	1 cm - 4000K CODICE CODE
GRIGIO VESUVIO ANTHRACITE	OPALE/OPAL	110H600021	110H700021	110H800021
ARGILLA CLAY		110H601021	110H701021	110H801021
ARGENTO OPACO/MATT SILVER		110H602021	110H702021	110H802021
BIANCO INTONACO/WHITE		110H603021	110H703021	110H803021
NERO CARAVAGGIO/BLACK		110H604021	110H704021	110H804021
MOKA MOCHA		110H605021	110H705021	110H805021
CROMO/CHROME		110H608021	110H708021	110H808021
ORO CALIFORNIA/GOLD		110H609021	110H709021	110H809021
ARAMEN COPPER		110H610021	110H710021	110H810021
GRIGIO AVIO/GREY AVIO		110H611021	110H711021	110H811021
ARGENTO COMETA/SILVER COMET		110H612021	110H712021	110H812021
OTTONE VENEZIANO/BRASS		110H613021	110H713021	110H813021
TITANIO/TITANIUM		110H614021	110H714021	110H814021
BRONZO RIACI/RIACI BRONZE		110H615021	110H715021	110H815021
VERDE COSTA/GREEN COAST		110H616021	110H716021	110H816021
TERRA SENESE/SENESE EARTH		110H617021	110H717021	110H817021

N.B./P.N.:

LUNGHEZZA MASSIMA VERSIONE CROMO = 2,00 m / MAXIMUM LENGTH CHROME VERSION = 2.00 m
TESTATE NON INCLUSE / DEAD ENDS NOT INCLUDED



zero35 - p

led integrato

integrated led

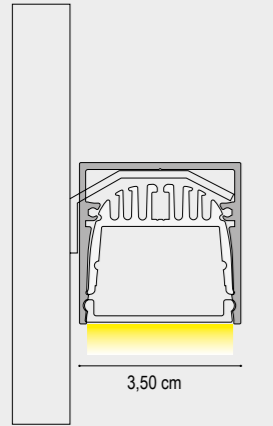

DATI TECNICI
TECHNICAL DATA

	1 cm	200 cm	300 cm
Nominal LED Flux:	2200 lm/m	4400 lm	6600 lm
Flux Tot:	1760 lm/m	3520 lm	5280 lm
Output:	105 lm/W	105 lm/W	105 lm/W
CCT:	3000 K	3000 K	3000 K
CRI:	>90	>90	>90
Power Tot:	20.0 W/m	40.0 W	60.0 W
Weight:	0.90 Kg/m	1.80 Kg	2.70 Kg

Profilo/Profile: Alluminio/aluminum Cover: Prismaticata/prismatic

DRIVER NON INCLUSO / NOT INCLUDED STAFFE DI FISSAGGIO A PARETE INCLUSE NEL CODICE WALL MOUNTING BRACKETS INCLUDED IN THE CODE CAVO ALIMENTAZIONE: 50 cm ALIMENTATION CABLE: 50 cm

zero35 - p

led integrato

integrated led

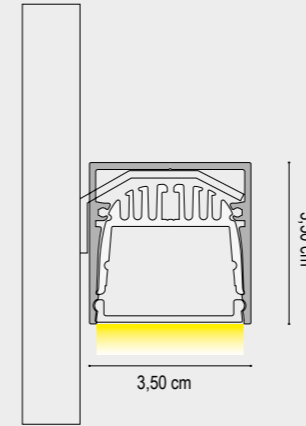

DATI TECNICI
TECHNICAL DATA

	1 cm
Nominal LED Flux:	2975 lm/m
Flux Tot:	2380 lm/m
Output:	125 lm/W
CCT:	3000 K
CRI:	>90
Power Tot:	23.0 W/m
Weight:	0.90 Kg/m

Profilo/Profile: Alluminio/aluminum Cover: Prismaticata/prismatic

DRIVER NON INCLUSO / NOT INCLUDED STAFFE DI FISSAGGIO A PARETE INCLUSE NEL CODICE WALL MOUNTING BRACKETS INCLUDED IN THE CODE CAVO ALIMENTAZIONE: 50 cm ALIMENTATION CABLE: 50 cm

FINITURA STRUTTURA FINISHES	DIFFUSORE DIFFUSER	1 cm	200 cm	300 cm
		CODICE CODE	CODICE CODE	CODICE CODE
GRIGIO VESUVIO ANTHRACITE	PRISMATIZZATO PRISMATIC	1104700041	1104700240	1104700340
ARGILLA CLAY		1104701041	1104701240	1104701340
ARGENTO OPACO MATT SILVER		1104702041	1104702240	1104702340
BIANCO INTONACO/WHITE		1104703041	1104703240	1104703340
NERO CARAVAGGIO BLACK		1104704041	1104704240	1104704340
MOKA MOCHA		1104705041	1104705240	1104705340
ORO CALIFORNIA/GOLD		1104709041	1104709240	1104709340
ARAMEN COPPER		1104710041	1104710240	1104710340
GRIGIO AVIO GREY AVIO		1104711041	1104711240	1104711340
ARGENTO COMETA/SILVER COMET		1104712041	1104712240	1104712340
OTTONE VENEZIANO BRASS		1104713041	1104713240	1104713340
TITANIO/TITANIUM		1104714041	1104714240	1104714340
BRONZO RIACI/RIACI BRONZE		1104715041	1104715240	1104715340
VERDE COSTA/GREEN COAST		1104716041	1104716240	1104716340
TERRA SENESE SENESE EARTH		1104717041	1104717240	1104717340
CROMO/CHROME		1104708041	1104708240	

N.B./P.N.:
LUNGHEZZA MASSIMA VERSIONE CROMO = 2,00 m / MAXIMUM LENGTH CHROME VERSION = 2.00 m
TESTATE NON INCLUSE / DEAD ENDS NOT INCLUDED

FINITURA STRUTTURA FINISHES	DIFFUSORE DIFFUSER	1 cm - 2700K	1 cm - 3000K	1 cm - 4000K
		CODICE CODE	CODICE CODE	CODICE CODE
GRIGIO VESUVIO ANTHRACITE	PRISMATIZZATO PRISMATIC	110H600041	110H700041	110H800041
ARGILLA CLAY		110H601041	110H701041	110H801041
ARGENTO OPACO MATT SILVER		110H602041	110H702041	110H802041
BIANCO INTONACO/WHITE		110H603041	110H703041	110H803041
NERO CARAVAGGIO BLACK		110H604041	110H704041	110H804041
MOKA MOCHA		110H605041	110H705041	110H805041
CROMO/CHROME		110H608041	110H708041	110H808041
ORO CALIFORNIA/GOLD		110H609041	110H709041	110H809041
ARAMEN COPPER		110H610041	110H710041	110H810041
GRIGIO AVIO GREY AVIO		110H611041	110H711041	110H811041
ARGENTO COMETA/SILVER COMET		110H612041	110H712041	110H812041
OTTONE VENEZIANO BRASS		110H613041	110H713041	110H813041
TITANIO/TITANIUM		110H614041	110H714041	110H814041
BRONZO RIACI/RIACI BRONZE		110H615041	110H715041	110H815041
VERDE COSTA/GREEN COAST		110H616041	110H716041	110H816041
TERRA SENESE SENESE EARTH		110H617041	110H717041	110H817041

N.B./P.N.:
LUNGHEZZA MASSIMA VERSIONE CROMO = 2,00 m / MAXIMUM LENGTH CHROME VERSION = 2.00 m
TESTATE NON INCLUSE / DEAD ENDS NOT INCLUDED



“moduli costumizzabili”

ZER035 SPOT ADVANCE è un prodotto composto da moduli customizzabili che consentono di avere sul medesimo sistema lineare diverse sorgenti luminose. A seconda delle necessità si può richiedere l'installazione di moduli SPOT abbinati a moduli LED. Lo ZER035 SPOT ADVANCE è un prodotto multi installazione: sospensione e soffitto. È particolarmente adatto per illuminare spazi espositivi.

ZER035 SPOT ADVANCE is a product composed of customizable modules that allow you to have different light sources on the same linear system. Depending on your needs, you can request the installation of SPOT modules combined with LED modules. The ZER035 SPOT ADVANCE is a multi-installation product: suspension and ceiling. It is particularly suitable for illuminating exhibition spaces.



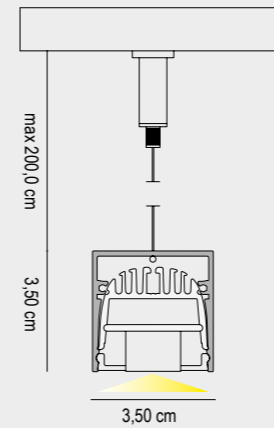
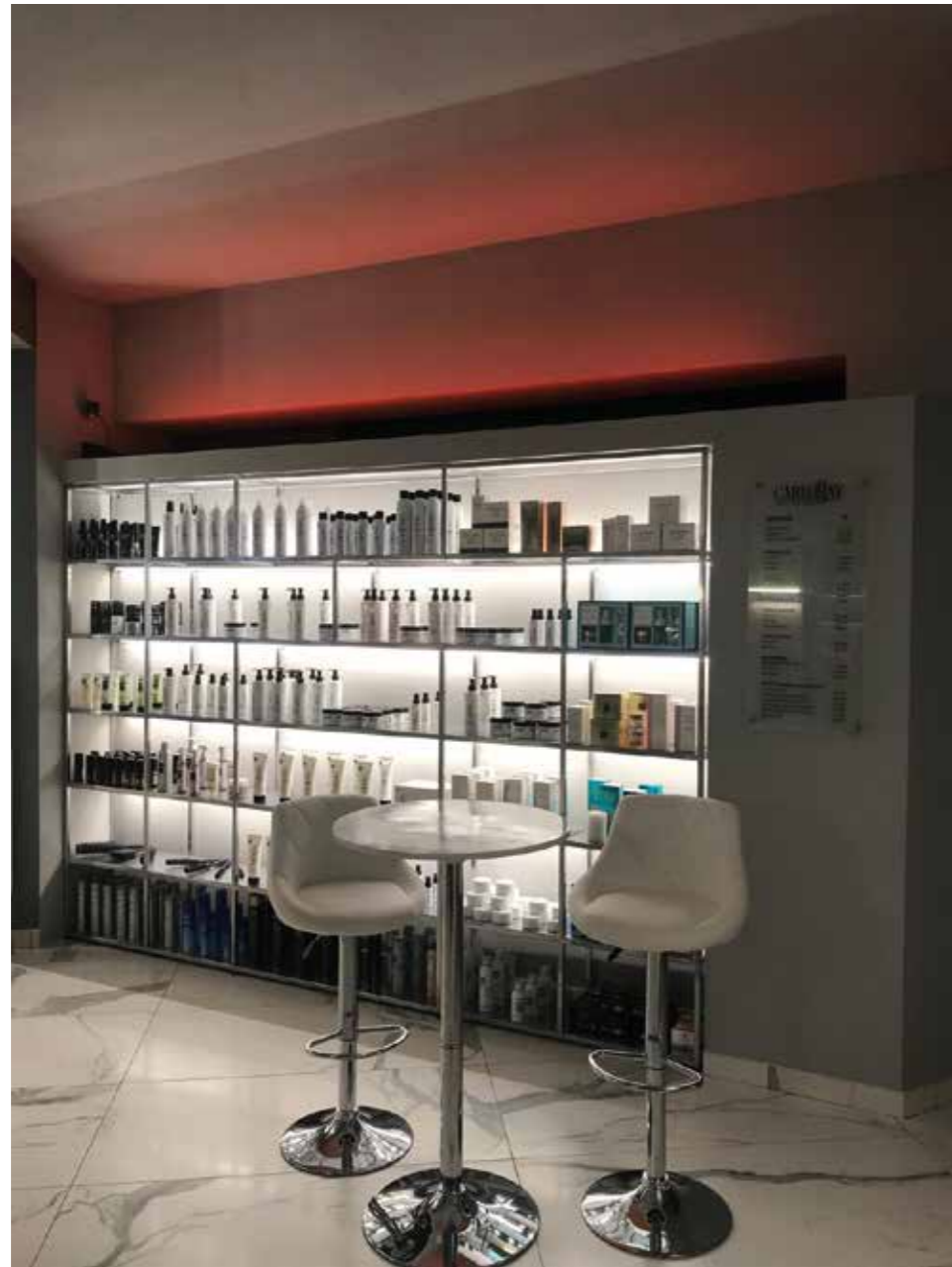

DATI TECNICI
TECHNICAL DATA

	120 cm (15+90+15)cm	150 cm (15+120+15)cm	180 cm (15+150+15)cm
Nominal LED Flux:	1980 lm	2640 lm	3300 lm
Nominal SPOT Flux:	1524 lm	1524 lm	1524 lm
Flux Tot:	2803 lm	3331 lm	3860 lm
Output:	105 lm/W + 121 lm/W	105 lm/W + 121 lm/W	105 lm/W + 121 lm/W
CCT:	3000 K	3000 K	3000 K
CRI:	>95	>95	>95
LED Power Tot:	18.0W	24.0W	30.0W
SPOT Power Tot:	18.0W (3W x 6)	18.0W (3W x 6)	18.0W (3W x 6)
Weight:	2.04 Kg	2.55 Kg	3.06 Kg

ARTICOLI INCLUSI NEL CODICE / ITEMS INCLUDED IN THE CODE:
DRIVER ON/OFF
COPPIA DI TESTATE DI CHIUSURA / PAIR OF CLOSING HEADS
KIT DI SOSPENSIONE / SUSPENSION KIT

FINITURA STRUTTURA
FINISHES

- GRIGIO VESUVIO ANTHRACITE
- ARGILLA CLAY
- BIANCO INTONACO/WHITE
- NERO CARAVAGGIO BLACK
- MOKA MOCHA
- CROMO CHROME
- ORO CALIFORNIA/GOLD
- ARAMEN COPPER
- GRIGIO AVIO/ GREY AVIO
- ARGENTO COMETA/SILVER COMET
- OTTONE VENEZIANO/ VENETIAN BRASS
- TITANIO/TITANIUM
- BRONZO RIACI/RIACI BRONZE
- VERDE COSTA/GREEN COAST
- TERRA SENESE SENESE EARTH
- NERO-CROMO BLACK-CHROME

DIFFUSORE
DIFFUSER

OPALE/OPAL

120 cm (15+90+15)cm 150 cm (15+120+15)cm 180 cm (15+150+15)cm

CODICE CODE	CODICE CODE	CODICE CODE
1108400120	1108400150	1108400180
1108401120	1108401150	1108401180
1108403120	1108403150	1108403180
1108404120	1108404150	1108404180
1108405120	1108405150	1108405180
1108408120	1108408150	1108408180
1108409120	1108409150	1108409180
1108410120	1108410150	1108410180
1108411120	1108411150	1108411180
1108412120	1108412150	1108412180
1108413120	1108413150	1108413180
1108414120	1108414150	1108414180
1108415120	1108415150	1108415180
1108416120	1108416150	1108416180
1108417120	1108417150	1108417180
1108448120	1108448150	1108448180

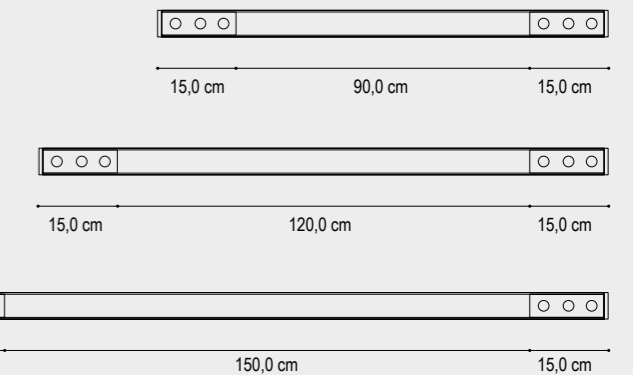

“sistema a led biemissione”

ZER035X costruito in estruso di alluminio si avvale della tecnologia degli schermi in policarbonato per diffondere la luce per mezzo di LED al top, per qualità, resa cromatica, lumen emessi, ed accurata selezione della temperatura colore, scelta in base al progetto scenografici +co che vogliamo ottenere. ZER035X è un sistema di illuminazione LED biemissione pensato per illuminare gli ambienti con una luce diretta sul piano e una luce diffusa. È proposto in due versioni: con ottica recessa (con valore di UGR<19 lungo l'asse trasversale) e con ottica esterna.

ZER035X built in extruded aluminum uses the technology of polycarbonate screens to diffuse the light by means of top LEDs, for quality, color rendering, lumens emitted, and careful selection of the color temperature, chosen on the basis of the scenographic project which we want to get. ZER035X is a bi-emission LED lighting system designed to illuminate environments with direct light on the surface and diffused light. It is proposed in two versions: with recessed optic (with UGR value <19 along the transverse axis) and with external optics.

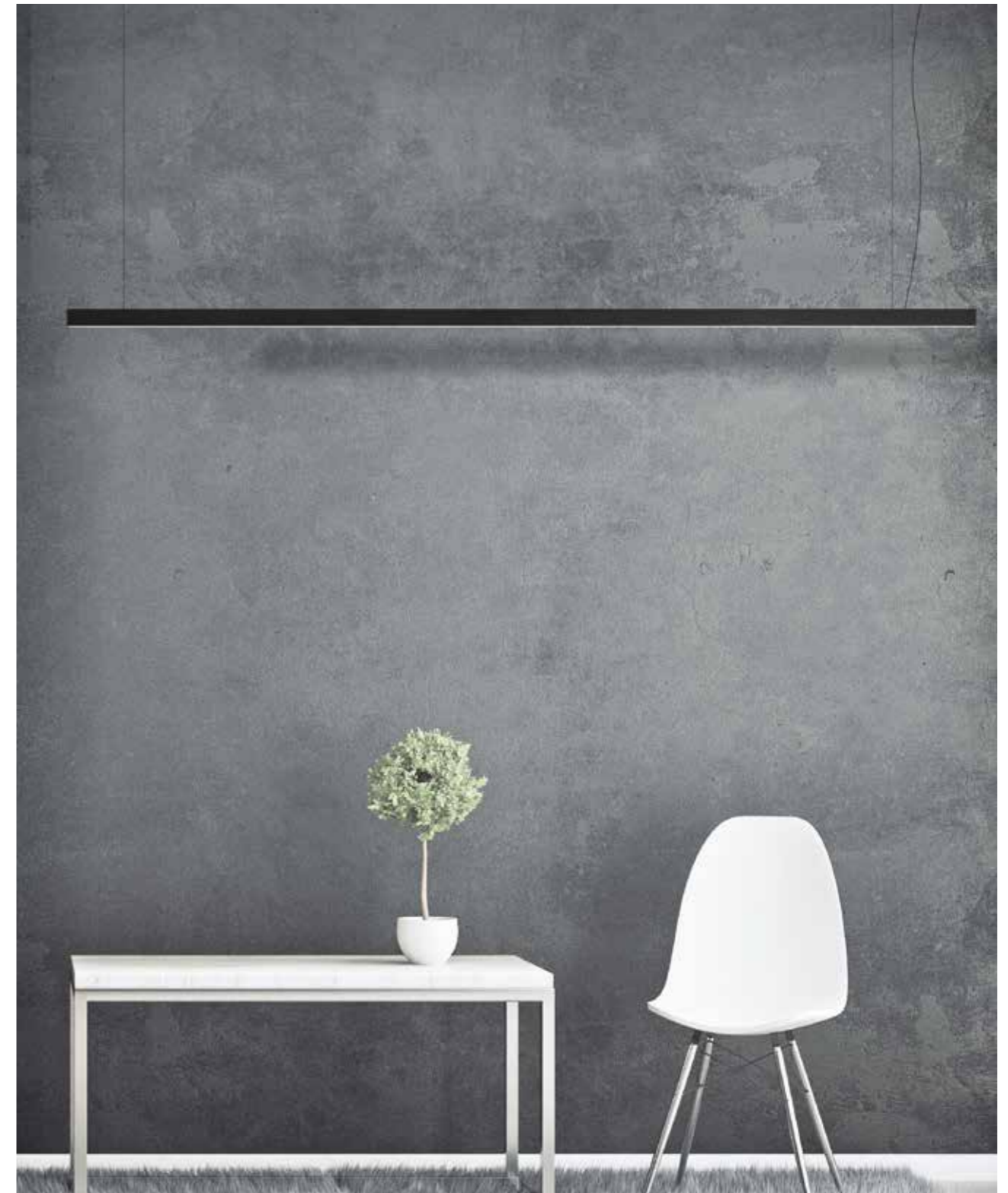

zero35 x

zero35 x

configurazioni

configurations

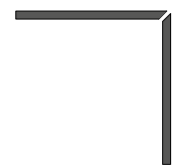

A. COMPOSIZIONE ANGOLARE A "L"
A. L-ANGLE COMPOSITION

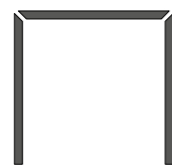

B. COMPOSIZIONE ANGOLARE A "C"
B. C-ANGLE COMPOSITION

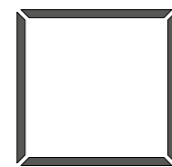

C. COMPOSIZIONE POLIGONALE (QUADRATO/RETTANGOLO)
C. POLYGONAL COMPOSITION (SQUARE / RECTANGLE)



D. COMPOSIZIONE POLIGONALE (PENTAGONO/ESAGONO)
D. POLYGONAL COMPOSITION (PENTAGON / HEX)

PER LE COMPOSIZIONI POLIGONALI RIVOLGERSI AL NOSTRO UFFICIO TECNICO.
FOR POLYGONAL COMPOSITIONS, PLEASE CONTACT OUR TECHNICAL OFFICE.

INSTALLAZIONE A SOSPENSIONE
SUSPENSION

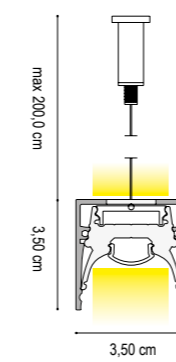

ZER035X CON DIFFUSORE RECESSO
ZER035X WITH RECESSED DIFFUSER

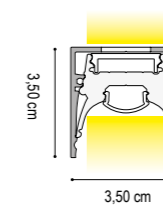

ZER035X CON DIFFUSORE ESTERNO
ZER035X WITH EXTERNAL DIFFUSER

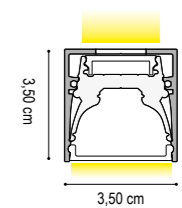

DATI TECNICI
TECHNICAL DATA

DIFFUSORE RECESSO / RECESSED DIFFUSER

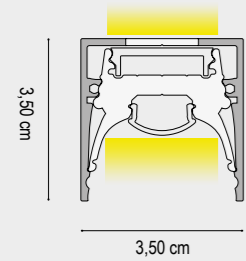

	1 cm - 40W/m	200 cm - 80W	300 cm - 120W
Nominal LED Flux:	↑ 2200 lm/m - 2200 lm/m ↓	↑ 4400 lm - 4400 lm ↓	↑ 6600 lm - 6600 lm ↓
Flux Tot:	↑ 1890 lm/m - 1680 lm/m ↓	↑ 3780 lm - 3360 lm ↓	↑ 5670 lm - 5040 lm ↓
Output:	110 lm/W	110 lm/W	110 lm/W
CCT:	3000 K	3000 K	3000 K
CRI:	>90	>90	>90
Power:	↑ 20.0W/m - 20.0W/m ↓	↑ 40.0W - 40.0W ↓	↑ 60.0W - 60.0W ↓
Power Tot:	40.0W/m	80.0W	120.0W
Weight:	1.40 Kg/m	2.80 Kg	4.20 Kg

Profilo/Profile: Alluminio/aluminum

Cover: Opale/opal - Satinato/Satin

Lmax = 300 cm

DRIVER NON INCLUSO / NOT INCLUDED

CAVO ALIMENTAZIONE: 50 cm
ALIMENTATION CABLE: 50 cm

DATI TECNICI
TECHNICAL DATA

DIFFUSORE RECESSO / RECESSED DIFFUSER

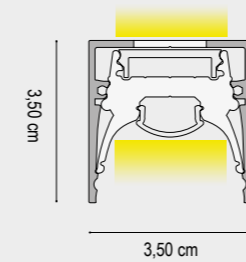

	1 cm - 40W/m	200 cm - 80W	300 cm - 120W
Nominal LED Flux:	↑ 4440 lm/m - 4440 lm/m ↓	↑ 8880 lm - 8880 lm ↓	↑ 13320 lm - 13320 lm ↓
Flux Tot:	↑ 3552 lm/m - 3552 lm/m ↓	↑ 7104 lm - 7104 lm ↓	↑ 10656 lm - 10656 lm ↓
Output:	148 lm/W	148 lm/W	148 lm/W
CCT:	3000 K	3000 K	3000 K
CRI:	>90	>90	>90
Power:	↑ 30.0W/m - 30.0W/m ↓	↑ 60.0W - 60.0W ↓	↑ 90.0W - 90.0W ↓
Power Tot:	60.0W/m	120.0W	180.0W
Weight:	1.40 Kg/m	2.80 Kg	4.20 Kg

Profilo/Profile: Alluminio/aluminum

Cover: Opale/opal - Satinato/Satin

Lmax = 300 cm

DRIVER NON INCLUSO / NOT INCLUDED

CAVO ALIMENTAZIONE: 50 cm
ALIMENTATION CABLE: 50 cm

FINITURA STRUTTURA
FINISHES

- GRIGIO VESUVIO ANTHRACITE
- ARGILLA CLAY
- ARGENTO OPACO/MATT SILVER
- BIANCO INTONACO/WHITE
- NERO CARAVAGGIO BLACK
- MOKA MOCHA
- ORO CALIFORNIA/GOLD
- ARAMEN COPPER
- GRIGIO AVIO/GREY AVIO
- ARGENTO COMETA/SILVER COMET
- OTTONE VENEZIANO BRASS
- TITANIO/TITANIUM
- BRONZO RIACI/RIACI BRONZE
- VERDE COSTA/GREEN COAST
- TERRA SENESE SENESE EARTH
- CROMO/CHROME

DIFFUSORE
DIFFUSER

- SATINATA/SATIN
- OPALE/OPAL

	1 cm	200 cm	300 cm
CODICE CODE	CODICE CODE	CODICE CODE	CODICE CODE
1164700001	1164700200	1164700300	
1164701001	1164701200	1164701300	
1164702001	1164702200	1164702300	
1164703001	1164703200	1164703300	
1164704001	1164704200	1164704300	
1164705001	1164705200	1164705300	
1164709001	1164709200	1164709300	
1164710001	1164710200	1164710300	
1164711001	1164711200	1164711300	
1164712001	1164712200	1164712300	
1164713001	1164713200	1164713300	
1164714001	1164714200	1164714300	
1164715001	1164715200	1164715300	
1164716001	1164716200	1164716300	
1164717001	1164717200	1164717300	
1164708001	1164708200		

N.B./P.N.:

LUNGHEZZA MASSIMA VERSIONE CROMO = 2,00 m / MAXIMUM LENGTH CHROME VERSION = 2.00 m
TESTATE NON INCLUSE / DEAD ENDS NOT INCLUDED

IL DISSIPATORE INTERNO VIENE FORNITO DI SERIE IN FINITURA ALLUMINIO/ THE INTERNAL HEAT SINK IS SUPPLIED AS STANDARD IN ALUMINUM FINISH

FINITURA STRUTTURA
FINISHES

- GRIGIO VESUVIO ANTHRACITE
- ARGILLA CLAY
- ARGENTO OPACO/MATT SILVER
- BIANCO INTONACO/WHITE
- NERO CARAVAGGIO BLACK
- MOKA MOCHA
- ORO CALIFORNIA/GOLD
- ARAMEN COPPER
- GRIGIO AVIO/GREY AVIO
- ARGENTO COMETA/SILVER COMET
- OTTONE VENEZIANO BRASS
- TITANIO/TITANIUM
- BRONZO RIACI/RIACI BRONZE
- VERDE COSTA/GREEN COAST
- TERRA SENESE SENESE EARTH
- CROMO/CHROME

DIFFUSORE
DIFFUSER

- SATINATA/SATIN
- OPALE/OPAL

	1 cm	200 cm	300 cm
CODICE CODE	CODICE CODE	CODICE CODE	CODICE CODE
1168100001	1168100200	1168100300	
1168101001	1168101200	1168101300	
1168102001	1168102200	1168102300	
1168103001	1168103200	1168103300	
1168104001	1168104200	1168104300	
1168105001	1168105200	1168105300	
1168109001	1168109200	1168109300	
1168110001	1168110200	1168110300	
1168111001	1168111200	1168111300	
1168112001	1168112200	1168112300	
1168113001	1168113200	1168113300	
1168114001	1168114200	1168114300	
1168115001	1168115200	1168115300	
1168116001	1168116200	1168116300	
1168117001	1168117200	1168117300	
1168108001	1168108200		

N.B./P.N.:

LUNGHEZZA MASSIMA VERSIONE CROMO = 2,00 m / MAXIMUM LENGTH CHROME VERSION = 2.00 m
TESTATE NON INCLUSE / DEAD ENDS NOT INCLUDED

IL DISSIPATORE INTERNO VIENE FORNITO DI SERIE IN FINITURA ALLUMINIO/ THE INTERNAL HEAT SINK IS SUPPLIED AS STANDARD IN ALUMINUM FINISH

zero35 x

led integrato

integrated led

DATI TECNICI
TECHNICAL DATA

DIFFUSORE ESTERNO / EXTERNAL DIFFUSER

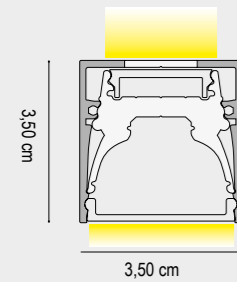

	1 cm - 40W/m	200 cm - 80W	300 cm - 120W
Nominal LED Flux:	↑2200 lm/m - 2200 lm/m ↓	↑4400 lm - 4400 lm ↓	↑6600 lm - 6600 lm ↓
Flux Tot:	↑1890 lm/m - 1680 lm/m ↓	↑3780 lm - 3360 lm ↓	↑5670 lm - 5040 lm ↓
Output:	110 lm/W	110 lm/W	110 lm/W
CCT:	3000 K	3000 K	3000 K
CRI:	>90	>90	>90
Power:	↑20.0W/m - 20.0W/m ↓	↑40.0W - 40.0W ↓	↑60.0W - 60.0W ↓
Power Tot:	40.0W/m	80.0W	120.0W
Weight:	1.40 Kg/m	2.80 Kg	4.20 Kg

Profilo/Profile: Alluminio/aluminum

Cover: Opale/opal - Satinato/Satin

Lmax = 300 cm

DRIVER NON INCLUSO / NOT INCLUDED

CAVO ALIMENTAZIONE: 50 cm
ALIMENTATION CABLE: 50 cm

zero35 x

led integrato

integrated led

DATI TECNICI
TECHNICAL DATA

DIFFUSORE ESTERNO / EXTERNAL DIFFUSER

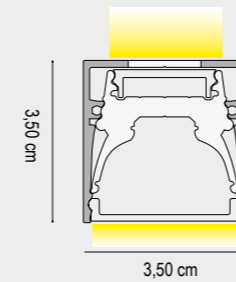

	1 cm - 40W/m	200 cm - 80W	300 cm - 120W
Nominal LED Flux:	↑4440 lm/m - 4440 lm/m ↓	↑8880 lm - 8880 lm ↓	↑13320 lm - 13320 lm ↓
Flux Tot:	↑3552 lm/m - 3552 lm/m ↓	↑7104 lm - 7104 lm ↓	↑10656 lm - 10656 lm ↓
Output:	148 lm/W	148 lm/W	148 lm/W
CCT:	3000 K	3000 K	3000 K
CRI:	>90	>90	>90
Power:	↑30.0W/m - 30.0W/m ↓	↑60.0W - 60.0W ↓	↑90.0W - 90.0W ↓
Power Tot:	60.0W/m	120.0W	180.0W
Weight:	1.40 Kg/m	2.80 Kg	4.20 Kg

Profilo/Profile: Alluminio/aluminum

Cover: Opale/opal - Satinato/Satin

Lmax = 300 cm

DRIVER NON INCLUSO / NOT INCLUDED

CAVO ALIMENTAZIONE: 50 cm
ALIMENTATION CABLE: 50 cm

FINITURA STRUTTURA
FINISHES

- GRIGIO VESUVIO ANTHRACITE
- ARGILLA CLAY
- ARGENTO OPACO MATT SILVER
- BIANCO INTONACO/WHITE
- NERO CARAVAGGIO BLACK
- MOKA MOCHA
- ORO CALIFORNIA/GOLD
- ARAMEN COPPER
- GRIGIO AVIO/GREY AVIO
- ARGENTO COMETA/SILVER COMET
- OTTONE VENEZIANO BRASS
- TITANIO/TITANIUM
- BRONZO RIACI/RIACI BRONZE
- VERDE COSTA/GREEN COAST
- TERRA SENESE SENESE EARTH
- CROMO/CHROME

DIFFUSORE
DIFFUSER

- SATINATA/SATIN
- OPALE/OPAL

	1 cm	200 cm	300 cm
CODICE CODE			
	1164700011	1164700210	1164700310
	1164701011	1164701210	1164701310
	1164702011	1164702210	1164702310
	1164703011	1164703210	1164703310
	1164704011	1164704210	1164704310
	1164705011	1164705210	1164705310
	1164709011	1164709210	1164709310
	1164710011	1164710210	1164710310
	1164711011	1164711210	1164711310
	1164712011	1164712210	1164712310
	1164713011	1164713210	1164713310
	1164714011	1164714210	1164714310
	1164715011	1164715210	1164715310
	1164716011	1164716210	1164716310
	1164717011	1164717210	1164717310
	1164708011	1164708210	

N.B./P.N.:

LUNGHEZZA MASSIMA VERSIONE CROMO = 2,00 m / MAXIMUM LENGTH CHROME VERSION = 2.00 m

TESTATE NON INCLUSE / DEAD ENDS NOT INCLUDED

IL DISSIPATORE INTERNO VIENE FORNITO DI SERIE IN FINITURA ALLUMINIO/ THE INTERNAL HEAT SINK IS SUPPLIED AS STANDARD IN ALUMINUM FINISH

FINITURA STRUTTURA
FINISHES

- GRIGIO VESUVIO ANTHRACITE
- ARGILLA CLAY
- ARGENTO OPACO MATT SILVER
- BIANCO INTONACO/WHITE
- NERO CARAVAGGIO BLACK
- MOKA MOCHA
- ORO CALIFORNIA/GOLD
- ARAMEN COPPER
- GRIGIO AVIO/GREY AVIO
- ARGENTO COMETA/SILVER COMET
- OTTONE VENEZIANO BRASS
- TITANIO/TITANIUM
- BRONZO RIACI/RIACI BRONZE
- VERDE COSTA/GREEN COAST
- TERRA SENESE SENESE EARTH
- CROMO/CHROME

DIFFUSORE
DIFFUSER

- SATINATA/SATIN
- OPALE/OPAL

	1 cm	200 cm	300 cm
CODICE CODE			
	1168100011	1168100210	1168100310
	1168101011	1168101210	1168101310
	1168102011	1168102210	1168102310
	1168103011	1168103210	1168103310
	1168104011	1168104210	1168104310
	1168105011	1168105210	1168105310
	1168109011	1168109210	1168109310
	1168110011	1168110210	1168110310
	1168111011	1168111210	1168111310
	1168112011	1168112210	1168112310
	1168113011	1168113210	1168113310
	1168114011	1168114210	1168114310
	1168115011	1168115210	1168115310
	1168116011	1168116210	1168116310
	1168117011	1168117210	1168117310
	1168108011	1168108210	

N.B./P.N.:

LUNGHEZZA MASSIMA VERSIONE CROMO = 2,00 m / MAXIMUM LENGTH CHROME VERSION = 2.00 m

TESTATE NON INCLUSE / DEAD ENDS NOT INCLUDED

IL DISSIPATORE INTERNO VIENE FORNITO DI SERIE IN FINITURA ALLUMINIO/ THE INTERNAL HEAT SINK IS SUPPLIED AS STANDARD IN ALUMINUM FINISH



DATI TECNICI
TECHNICAL DATA

DIFFUSORE PRISMATIZZATO / PRISMATIC DIFFUSER

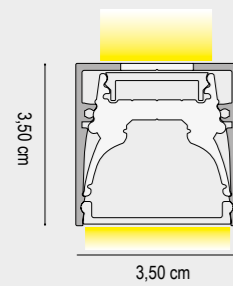

	1 cm - 40W/m	200 cm - 80W	300 cm - 120W
Nominal LED Flux:	↑ 3150 lm/m - 3150 lm/m ↓	↑ 6300 lm - 6300 lm ↓	↑ 9450 lm - 9450 lm ↓
Flux Tot:	↑ 2835 lm/m - 2520 lm/m ↓	↑ 5670 lm - 5040 lm ↓	↑ 8505 lm - 7560 lm ↓
Output:	105 lm/W	105 lm/W	105 lm/W
CCT:	3000 K	3000 K	3000 K
CRI:	>90	>90	>90
Power:	↑ 30.0W/m - 30.0W/m ↓	↑ 60.0W - 60.0W ↓	↑ 90.0W - 90.0W ↓
Power Tot:	60.0W/m	120.0W	180.0W
Weight:	1.40 Kg/m	2.80 Kg	4.20 Kg

Profilo/Profile: Alluminio/aluminum

Cover: Prismatizzato/prismatic - Satinato/Satin

DRIVER NON INCLUSO / NOT INCLUDED

CAVO ALIMENTAZIONE: 50 cm
ALIMENTATION CABLE: 50 cm

FINITURA STRUTTURA
FINISHES

- GRIGIO VESUVIO ANTHRACITE
- ARGILLA CLAY
- ARGENTO OPACO MATT SILVER
- BIANCO INTONACO/WHITE
- NERO CARAVAGGIO BLACK
- MOKA MOCHA
- ORO CALIFORNIA GOLD
- ARAMEN COPPER
- GRIGIO AVIO GREY AVIO
- ARGENTO COMETA/SILVER COMET
- OTTONE VENEZIANO BRASS
- TITANIO/TITANIUM
- BRONZO RIACI/RIACI BRONZE
- VERDE COSTA/GREEN COAST
- TERRA SENESE SENESE EARTH
- CROMO/CHROME

DIFFUSORE
DIFFUSER

- SATINATA/SATIN
- PRISMATIZZATO
PRISMATIC

	1 cm	200 cm	300 cm
CODICE CODE			
	1168100031	1168100230	1168100330
	1168101031	1168101230	1168101330
	1168102031	1168102230	1168102330
	1168103031	1168103230	1168103330
	1168104031	1168104230	1168104330
	1168105031	1168105230	1168105330
	1168109031	1168109230	1168109330
	1168110031	1168110230	1168110330
	1168111031	1168111230	1168111330
	1168112031	1168112230	1168112330
	1168113031	1168113230	1168113330
	1168114031	1168114230	1168114330
	1168115031	1168115230	1168115330
	1168116031	1168116230	1168116330
	1168117031	1168117230	1168117330
	1168108031	1168108230	

N.B./P.N.:

LUNGHEZZA MASSIMA VERSIONE CROMO = 2,00 m / MAXIMUM LENGTH CHROME VERSION = 2.00 m
TESTATE NON INCLUSE / DEAD ENDS NOT INCLUDED



“ottica recessa e ottica esterna”

ZER035X costruito in estruso di alluminio si avvale della tecnologia degli schermi in policarbonato per diffondere la luce per mezzo di LED al top, per qualità, resa cromatica, lumen emessi, ed accurata selezione della temperatura colore, scelta in base al progetto scenografico che vogliamo ottenere. ZER035X è un sistema di illuminazione LED biemissione pensato per illuminare gli ambienti con una luce diretta sul piano e una luce diffusa. È proposto in due versioni: con ottica recessa (con valore di UGR<19 lungo l'asse trasversale) e con ottica esterna.

ZER035X built in extruded aluminum uses the technology of polycarbonate screens to diffuse the light by means of top LEDs, for quality, color rendering, lumens emitted, and careful selection of the color temperature, chosen on the basis of the scenographic project which we want to get. ZER035X is a bi-emission LED lighting system designed to illuminate environments with direct light on the surface and diffused light. It is proposed in two versions: with recessed optic (with UGR value <19 along the transverse axis) and with external optics.





ZER035X-P CON DIFFUSORE RECESSO
ZER035X-P WITH RECESSED DIFFUSER

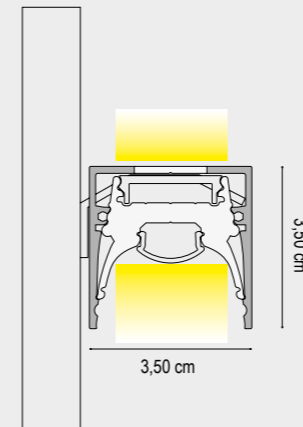

ZER035X-P CON DIFFUSORE ESTERNO
ZER035X-P WITH EXTERNAL DIFFUSER

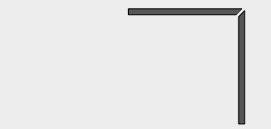
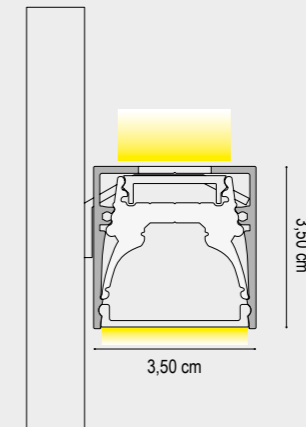

A. COMPOSIZIONE ANGOLARE A "L"
A. L-ANGLE COMPOSITION



B. COMPOSIZIONE ANGOLARE A "C"
B. C-ANGLE COMPOSITION

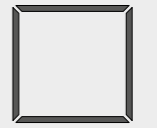

C. COMPOSIZIONE POLIGONALE
(QUADRATO/RETTANGOLO)
C. POLYGONAL COMPOSITION
(SQUARE / RECTANGLE)

INSTALLAZIONE STAFFA A PARETE
WALL BRACKET INSTALLATION

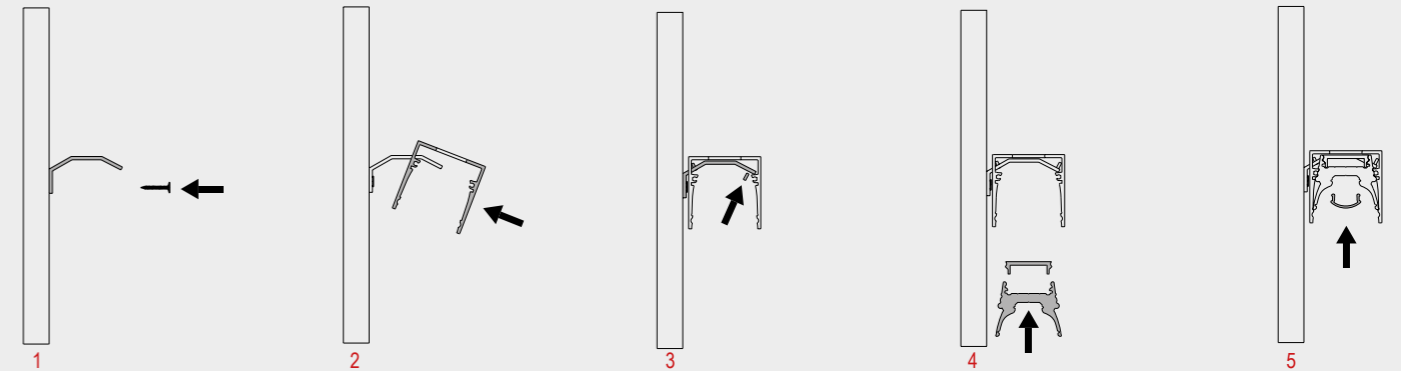

1. FISSARE LE STAFFE UTILIZZANDO SISTEMI DI FISSAGGIO IDONEI AL TIPO DI PARETE. PRESTARE ATTENZIONE ALL'ALLINEAMENTO DELLE STAFFE PER UNA CORRETTA INSTALLAZIONE DEL PRODOTTO. IN CASO DI INSTALLAZIONE SU PARETE NON LINEARE, SI CONSIGLIA DI UTILIZZARE SUPPORTI DISTANZIALI AL FINE DI EVITARNE LA TORSIONE.

1. FIX THE BRACKETS USING FASTENING SYSTEMS SUITABLE FOR THE TYPE OF WALL. PAY ATTENTION TO THE ALIGNMENT OF THE BRACKETS FOR A CORRECT INSTALLATION OF THE PRODUCT. IN THE EVENT OF INSTALLATION ON A NON-LINEAR WALL, IT IS RECOMMENDED TO USE SPACER SUPPORTS IN ORDER TO AVOID TORSION.

2. SUL LATO DEL PROFILO RIVOLTO VERSO LA PARETE È PRESENTE UN'ASOLA. INSERIRE LA STAFFA NELL'ASOLA.

2. THERE IS A SLOT ON THE SIDE OF THE PROFILE FACING THE WALL. INSERT THE BRACKET IN THE SLOT.

3. BLOCCARE IL PROFILO ALLA STAFFA UTILIZZANDO GLI APPOSITI GRANI FILETTATI.

3. LOCK THE PROFILE TO THE BRACKET USING THE SPECIAL THREADED DOWELS.

4. INSERIRE IL DISSIPATORE IN ALLUMINIO E LA COVER SUPERIORE IN POLICARBONATO. ATTENZIONE! ASSICURARSI DEL PERFETTO SCATTO TRA IL DISSIPATORE E IL PROFILO. UN'INSTALLAZIONE ERRATA PUÒ COMPROMETTERE LA TENUTA E LA DURABILITÀ DEL PRODOTTO.

4. INSERT THE ALUMINUM HEAT SINK AND THE UPPER POLYCARBONATE COVER. WARNING! MAKE SURE THE PERFECT SNAP BETWEEN THE HEAT SINK AND THE PROFILE. AN INCORRECT INSTALLATION MAY COMPROMISE THE SEALING AND DURABILITY OF THE PRODUCT.

5. INSERIRE LA COVER INFERIORE IN POLICARBONATO.

5. INSERT THE POLYCARBONATE COVER.

zero35 xp

led integrato

integrated led

DATI TECNICI
TECHNICAL DATA

	DIFFUSORE RECESSO / RECESSED DIFFUSER		
	1 cm - 40W/m	200 cm - 80W	300 cm - 120W
Nominal LED Flux:	↑2200 lm/m - 2200 lm/m ↓	↑4400 lm - 4400 lm ↓	↑6600 lm - 6600 lm ↓
Flux Tot:	↑1760 lm/m - 1760 lm/m ↓	↑3520 lm - 3520 lm ↓	↑5280 lm - 5280 lm ↓
Output:	105 lm/W	105 lm/W	105 lm/W
CCT:	3000 K	3000 K	3000 K
CRI:	>90	>90	>90
Power:	↑20.0W/m - 20.0W/m ↓	↑40.0W - 40.0W ↓	↑60.0W - 60.0W ↓
Power Tot:	40.0W/m	80.0W	120.0W
Weight:	1.40 Kg/m	2.80 Kg	4.20 Kg
Profilo/Profile:	Alluminio/aluminum		
Cover:	Opale/opal - Satinato/Satin		

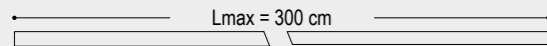

DRIVER NON INCLUSO / NOT INCLUDED CAVO ALIMENTAZIONE: 50 cm ALIMENTATION CABLE: 50 cm

zero35 xp

led integrato

integrated led

DATI TECNICI
TECHNICAL DATA

	DIFFUSORE RECESSO / RECESSED DIFFUSER		
	1 cm - 40W/m	200 cm - 80W	300 cm - 120W
Nominal LED Flux:	↑4440 lm/m - 4440 lm/m ↓	↑8880 lm - 8880 lm ↓	↑13320 lm - 13320 lm ↓
Flux Tot:	↑3552 lm/m - 3552 lm/m ↓	↑7104 lm - 7104 lm ↓	↑10656 lm - 10656 lm ↓
Output:	148 lm/W	148 lm/W	148 lm/W
CCT:	3000 K	3000 K	3000 K
CRI:	>90	>90	>90
Power:	↑30.0W/m - 30.0W/m ↓	↑60.0W - 60.0W ↓	↑90.0W - 90.0W ↓
Power Tot:	60.0W/m	120.0W	180.0W
Weight:	1.40 Kg/m	2.80 Kg	4.20 Kg
Profilo/Profile:	Alluminio/aluminum		
Cover:	Opale/opal - Satinato/Satin		

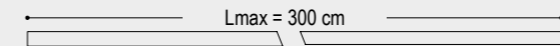

DRIVER NON INCLUSO / NOT INCLUDED CAVO ALIMENTAZIONE: 50 cm ALIMENTATION CABLE: 50 cm

FINITURA STRUTTURA FINISHES	DIFFUSORE DIFFUSER	1 cm	200 cm	300 cm
GRIGIO VESUVIO ANTHRACITE		1164700021	1164700220	1164700320
ARGILLA CLAY		1164701021	1164701220	1164701320
ARGENTO OPACO MATT SILVER		1164702021	1164702220	1164702320
BIANCO INTONACO/WHITE		1164703021	1164703220	1164703320
NERO CARAVAGGIO BLACK		1164704021	1164704220	1164704320
MOKA MOCHA		1164705021	1164705220	1164705320
ORO CALIFORNIA GOLD		1164709021	1164709220	1164709320
ARAMEN COPPER	SATINATA/SATIN	1164710021	1164710220	1164710320
GRIGIO AVIO GREY AVIO	OPALE/OPAL	1164711021	1164711220	1164711320
ARGENTO COMETA/SILVER COMET		1164712021	1164712220	1164712320
OTTONE VENEZIANO BRASS		1164713021	1164713220	1164713320
TITANIO/TITANIUM		1164714021	1164714220	1164714320
BRONZO RIACI/RIACI BRONZE		1164715021	1164715220	1164715320
VERDE COSTA/GREEN COAST		1164716021	1164716220	1164716320
TERRA SENESE SENESE EARTH		1164717021	1164717220	1164717320
CROMO/CHROME		1164708021	1164708220	

N.B./P.N.:
LUNGHEZZA MASSIMA VERSIONE CROMO = 2,00 m / MAXIMUM LENGTH CHROME VERSION = 2.00 m
TESTATE NON INCLUSE / DEAD ENDS NOT INCLUDED
IL DISSIPATORE INTERNO VIENE FORNITO DI SERIE IN FINITURA ALLUMINIO NATURALE / THE EXTERNAL HEATSINK IS SUPPLIED AS STANDARD IN A NATURAL ALUMINIUM FINISH

FINITURA STRUTTURA FINISHES	DIFFUSORE DIFFUSER	1 cm	200 cm	300 cm
GRIGIO VESUVIO ANTHRACITE		1168100021	1168100220	1168100320
ARGILLA CLAY		1168101021	1168101220	1168101320
ARGENTO OPACO MATT SILVER		1168102021	1168102220	1168102320
BIANCO INTONACO/WHITE		1168103021	1168103220	1168103320
NERO CARAVAGGIO BLACK		1168104021	1168104220	1168104320
MOKA MOCHA		1168105021	1168105220	1168105320
ORO CALIFORNIA GOLD		1168109021	1168109220	1168109320
ARAMEN COPPER	SATINATA/SATIN	1168110021	1168110220	1168110320
GRIGIO AVIO GREY AVIO	OPALE/OPAL	1168111021	1168111220	1168111320
ARGENTO COMETA/SILVER COMET		1168112021	1168112220	1168112320
OTTONE VENEZIANO BRASS		1168113021	1168113220	1168113320
TITANIO/TITANIUM		1168114021	1168114220	1168114320
BRONZO RIACI/RIACI BRONZE		1168115021	1168115220	1168115320
VERDE COSTA/GREEN COAST		1168116021	1168116220	1168116320
TERRA SENESE SENESE EARTH		1168117021	1168117220	1168117320
CROMO/CHROME		1168108021	1168108220	

N.B./P.N.:
LUNGHEZZA MASSIMA VERSIONE CROMO = 2,00 m / MAXIMUM LENGTH CHROME VERSION = 2.00 m
TESTATE NON INCLUSE / DEAD ENDS NOT INCLUDED
IL DISSIPATORE INTERNO VIENE FORNITO DI SERIE IN FINITURA ALLUMINIO NATURALE / THE EXTERNAL HEATSINK IS SUPPLIED AS STANDARD IN A NATURAL ALUMINIUM FINISH



DATI TECNICI
TECHNICAL DATA

	DIFFUSORE ESTERNO / EXTERNAL DIFFUSER		
	1 cm - 40W/m	200 cm - 80W	300 cm - 120W
Nominal LED Flux:	↑ 2200 lm/m - 2200 lm/m ↓	↑ 4400 lm - 4400 lm ↓	↑ 6600 lm - 6600 lm ↓
Flux Tot:	↑ 1760 lm/m - 1760 lm/m ↓	↑ 3520 lm - 3520 lm ↓	↑ 5280 lm - 5280 lm ↓
Output:	105 lm/W	105 lm/W	105 lm/W
CCT:	3000 K	3000 K	3000 K
CRI:	>90	>90	>90
Power:	↑ 20.0W/m - 20.0W/m ↓	↑ 40.0W - 40.0W ↓	↑ 60.0W - 60.0W ↓
Power Tot:	40.0W/m	80.0W	120.0W
Weight:	1.40 Kg/m	2.80 Kg	4.20 Kg
Profilo/Profile:	Alluminio/aluminum		
Cover:	Satinato/Satin Prismatizzato/Prismatic		

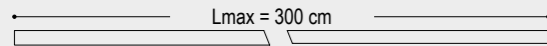

DRIVER NON INCLUSO / NOT INCLUDED CAVO ALIMENTAZIONE: 50 cm
ALIMENTATION CABLE: 50 cm

DATI TECNICI
TECHNICAL DATA

	DIFFUSORE ESTERNO / EXTERNAL DIFFUSER		
	1 cm - 40W/m	200 cm - 80W	300 cm - 120W
Nominal LED Flux:	↑ 4440 lm/m - 4440 lm/m ↓	↑ 8880 lm - 8880 lm ↓	↑ 13320 lm - 13320 lm ↓
Flux Tot:	↑ 3552 lm/m - 3552 lm/m ↓	↑ 7104 lm - 7104 lm ↓	↑ 10656 lm - 10656 lm ↓
Output:	148 lm/W	148 lm/W	148 lm/W
CCT:	3000 K	3000 K	3000 K
CRI:	>90	>90	>90
Power:	↑ 30.0W/m - 30.0W/m ↓	↑ 60.0W - 60.0W ↓	↑ 90.0W - 90.0W ↓
Power Tot:	60.0W/m	120.0W	180.0W
Weight:	1.40 Kg/m	2.80 Kg	4.20 Kg
Profilo/Profile:	Alluminio/aluminum		
Cover:	Satinato/Satin Prismatizzato/Prismatic		

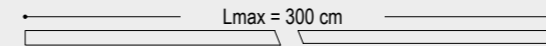

DRIVER NON INCLUSO / NOT INCLUDED CAVO ALIMENTAZIONE: 50 cm
ALIMENTATION CABLE: 50 cm

FINITURA STRUTTURA FINISHES	DIFFUSORE DIFFUSER	1 cm	200 cm	300 cm
		CODICE CODE	CODICE CODE	CODICE CODE
GRIGIO VESUVIO ANTHRACITE	SATINATA/SATIN PRISMATIZZATO PRISMATIC	1164700051	1164700250	1164700350
ARGILLA CLAY		1164701051	1164701250	1164701350
ARGENTO OPACO/MATT SILVER		1164702051	1164702250	1164702350
BIANCO INTONACO/WHITE		1164703051	1164703250	1164703350
NERO CARAVAGGIO BLACK		1164704051	1164704250	1164704350
MOKA MOCHA		1164705051	1164705250	1164705350
ORO CALIFORNIA/GOLD		1164709051	1164709250	1164709350
ARAMEN COPPER		1164710051	1164710250	1164710350
GRIGIO AVIO/ GREY AVIO		1164711051	1164711250	1164711350
ARGENTO COMETA/SILVER COMET		1164712051	1164712250	1164712350
OTTONE VENEZIANO BRASS		1164713051	1164713250	1164713350
TITANIO/TITANIUM		1164714051	1164714250	1164714350
BRONZO RIACI/RIACI BRONZE		1164715051	1164715250	1164715350
VERDE COSTA/GREEN COAST		1164716051	1164716250	1164716350
TERRA SENESE SENESE EARTH		1164717051	1164717250	1164717350
CROMO/CHROME		1164708051	1164708250	

N.B./P.N.:
LUNGHEZZA MASSIMA VERSIONE CROMO = 2,00 m / MAXIMUM LENGTH CHROME VERSION = 2.00 m
TESTATE NON INCLUSE / DEAD ENDS NOT INCLUDED
IL DISSIPATORE INTERNO VIENE FORNITO DI SERIE IN FINITURA ALLUMINIO NATURALE / THE EXTERNAL HEATSINK IS SUPPLIED AS STANDARD IN A NATURAL ALUMINIUM FINISH

FINITURA STRUTTURA FINISHES	DIFFUSORE DIFFUSER	1 cm	200 cm	300 cm
		CODICE CODE	CODICE CODE	CODICE CODE
GRIGIO VESUVIO ANTHRACITE	SATINATA/SATIN PRISMATIZZATO PRISMATIC	1168100051	1168100250	1168100350
ARGILLA CLAY		1168101051	1168101250	1168101350
ARGENTO OPACO/MATT SILVER		1168102051	1168102250	1168102350
BIANCO INTONACO/WHITE		1168103051	1168103250	1168103350
NERO CARAVAGGIO BLACK		1168104051	1168104250	1168104350
MOKA MOCHA		1168105051	1168105250	1168105350
ORO CALIFORNIA/GOLD		1168109051	1168109250	1168109350
ARAMEN COPPER		1168110051	1168110250	1168110350
GRIGIO AVIO/ GREY AVIO		1168111051	1168111250	1168111350
ARGENTO COMETA/SILVER COMET		1168112051	1168112250	1168112350
OTTONE VENEZIANO BRASS		1168113051	1168113250	1168113350
TITANIO/TITANIUM		1168114051	1168114250	1168114350
BRONZO RIACI/RIACI BRONZE		1168115051	1168115250	1168115350
VERDE COSTA/GREEN COAST		1168116051	1168116250	1168116350
TERRA SENESE SENESE EARTH		1168117051	1168117250	1168117350
CROMO/CHROME		1168108051	1168108250	

N.B./P.N.:
LUNGHEZZA MASSIMA VERSIONE CROMO = 2,00 m / MAXIMUM LENGTH CHROME VERSION = 2.00 m
TESTATE NON INCLUSE / DEAD ENDS NOT INCLUDED
IL DISSIPATORE INTERNO VIENE FORNITO DI SERIE IN FINITURA ALLUMINIO NATURALE / THE EXTERNAL HEATSINK IS SUPPLIED AS STANDARD IN A NATURAL ALUMINIUM FINISH

DATI TECNICI
TECHNICAL DATA

DIFFUSORE PRISMATIZZATO / PRISMATIC DIFFUSER

	1 cm - 40W/m	200 cm - 80W	300 cm - 120W
Nominal LED Flux:	↑ 2100 lm/m - 2100 lm/m ↓	↑ 4200 lm - 4200 lm ↓	↑ 6300 lm - 6300 lm ↓
Flux Tot:	↑ 1890 lm/m - 1680 lm/m ↓	↑ 3780 lm - 3360 lm ↓	↑ 5670 lm - 5040 lm ↓
Output:	105 lm/W	105 lm/W	105 lm/W
CCT:	3000 K	3000 K	3000 K
CRI:	>90	>90	>90
Power:	↑ 20.0W/m - 20.0W/m ↓	↑ 40.0W - 40.0W ↓	↑ 60.0W - 60.0W ↓
Power Tot:	40.0W/m	80.0W	120.0W
Weight:	1.40 Kg/m	2.80 Kg	4.20 Kg
Profilo/Profile:	Alluminio/aluminum		Cover: Prismatico/prismatic - Satinato/Satin



Lmax = 300 cm

DRIVER NON INCLUSO / NOT INCLUDED

CAVO ALIMENTAZIONE: 50 cm
ALIMENTATION CABLE: 50 cm

DATI TECNICI
TECHNICAL DATA

DIFFUSORE PRISMATIZZATO / PRISMATIC DIFFUSER

	1 cm - 40W/m	200 cm - 80W	300 cm - 120W
Nominal LED Flux:	↑ 4440 lm/m - 4440 lm/m ↓	↑ 8880 lm - 8880 lm ↓	↑ 13320 lm - 13320 lm ↓
Flux Tot:	↑ 3552 lm/m - 3552 lm/m ↓	↑ 7104 lm - 7104 lm ↓	↑ 10656 lm - 10656 lm ↓
Output:	148 lm/W	148 lm/W	148 lm/W
CCT:	3000 K	3000 K	3000 K
CRI:	>90	>90	>90
Power:	↑ 30.0W/m - 30.0W/m ↓	↑ 60.0W - 60.0W ↓	↑ 90.0W - 90.0W ↓
Power Tot:	60.0W/m	120.0W	180.0W
Weight:	1.40 Kg/m	2.80 Kg	4.20 Kg
Profilo/Profile:	Alluminio/aluminum		Cover: Prismatico/prismatic - Satinato/Satin

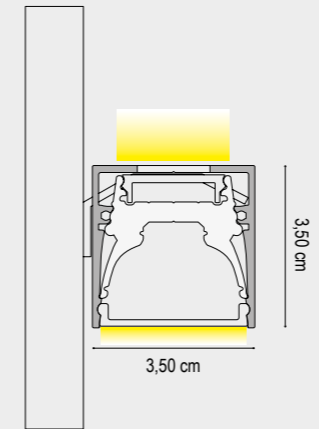

Lmax = 300 cm

DRIVER NON INCLUSO / NOT INCLUDED

CAVO ALIMENTAZIONE: 50 cm
ALIMENTATION CABLE: 50 cm

FINITURA STRUTTURA
FINISHES

- GRIGIO VESUVIO ANTHRACITE
- ARGILLA CLAY
- ARGENTO OPACO/MATT SILVER
- BIANCO INTONACO/WHITE
- NERO CARAVAGGIO/BLACK
- MOKA MOCHA
- ORO CALIFORNIA/GOLD
- ARAMEN COPPER
- GRIGIO AVIO/GREY AVIO
- ARGENTO COMETA/SILVER COMET
- OTTONE VENEZIANO/BRASS
- TITANIO/TITANIUM
- BRONZO RIACI/RIACI BRONZE
- VERDE COSTA/GREEN COAST
- TERRA SENESE/SENESE EARTH
- CROMO/CHROME

DIFFUSORE
DIFFUSER

- SATINATA/SATIN
- PRISMATIZZATO
PRISMATIC

	1 cm	200 cm	300 cm
CODICE CODE			
	1164700041	1164700240	1164700340
	1164701041	1164701240	1164701340
	1164702041	1164702240	1164702340
	1164703041	1164703240	1164703340
	1164704041	1164704240	1164704340
	1164705041	1164705240	1164705340
	1164709041	1164709240	1164709340
	1164710041	1164710240	1164710340
	1164711041	1164711240	1164711340
	1164712041	1164712240	1164712340
	1164713041	1164713240	1164713340
	1164714041	1164714240	1164714340
	1164715041	1164715240	1164715340
	1164716041	1164716240	1164716340
	1164717041	1164717240	1164717340
	1164708041	1164708240	

N.B./P.N.:

LUNGHEZZA MASSIMA VERSIONE CROMO = 2,00 m / MAXIMUM LENGTH CHROME VERSION = 2.00 m
TESTATE NON INCLUSE / DEAD ENDS NOT INCLUDED

FINITURA STRUTTURA
FINISHES

- GRIGIO VESUVIO ANTHRACITE
- ARGILLA CLAY
- ARGENTO OPACO/MATT SILVER
- BIANCO INTONACO/WHITE
- NERO CARAVAGGIO/BLACK
- MOKA MOCHA
- ORO CALIFORNIA/GOLD
- ARAMEN COPPER
- GRIGIO AVIO/GREY AVIO
- ARGENTO COMETA/SILVER COMET
- OTTONE VENEZIANO/BRASS
- TITANIO/TITANIUM
- BRONZO RIACI/RIACI BRONZE
- VERDE COSTA/GREEN COAST
- TERRA SENESE/SENESE EARTH
- CROMO/CHROME

DIFFUSORE
DIFFUSER

- SATINATA/SATIN
- PRISMATIZZATO
PRISMATIC

	1 cm	200 cm	300 cm
CODICE CODE			
	1168100041	1168100240	1168100340
	1168101041	1168101240	1168101340
	1168102041	1168102240	1168102340
	1168103041	1168103240	1168103340
	1168104041	1168104240	1168104340
	1168105041	1168105240	1168105340
	1168109041	1168109240	1168109340
	1168110041	1168110240	1168110340
	1168111041	1168111240	1168111340
	1168112041	1168112240	1168112340
	1168113041	1168113240	1168113340
	1168114041	1168114240	1168114340
	1168115041	1168115240	1168115340
	1168116041	1168116240	1168116340
	1168117041	1168117240	1168117340
	1168108041	1168108240	

N.B./P.N.:

LUNGHEZZA MASSIMA VERSIONE CROMO = 2,00 m / MAXIMUM LENGTH CHROME VERSION = 2.00 m
TESTATE NON INCLUSE / DEAD ENDS NOT INCLUDED

zero35 t + zero35 m

zero35 t + zero35 m

designer

luigi cerbone

**“per progetti da incasso
a parete oppure a soffitto”**

ZER035 T costruito in estruso di alluminio si avvale della tecnologia degli schermi in policarbonato per diffondere la luce per mezzo di LED Tal top, per qualità, resa cromatica, lumen emessi, ed accurata selezione della temperatura colore, scelta in base al progetto scenografico che vogliamo ottenere. ZER035 T offre una gamma di finiture e di accessori, i tagli lineari e a 45° o su MISURA, rendono realizzabile qualsiasi progetto sia esso da incasso a parete oppure a soffitto.

ZER035 T is made in extruded aluminium. Use polycarbonate technology for diffusing led light with high precision, use high quality like led, colour rendering, lumen output and accurate colour temperature for ensuring optimal results for each type of project. ZER035 T offers a wide gamma of finishing's and accessories, several lengths, 45°cuts or completely customized. With ZER035 T it's possible to realize any kind of projects like wall-recessed or ceiling-recessed.

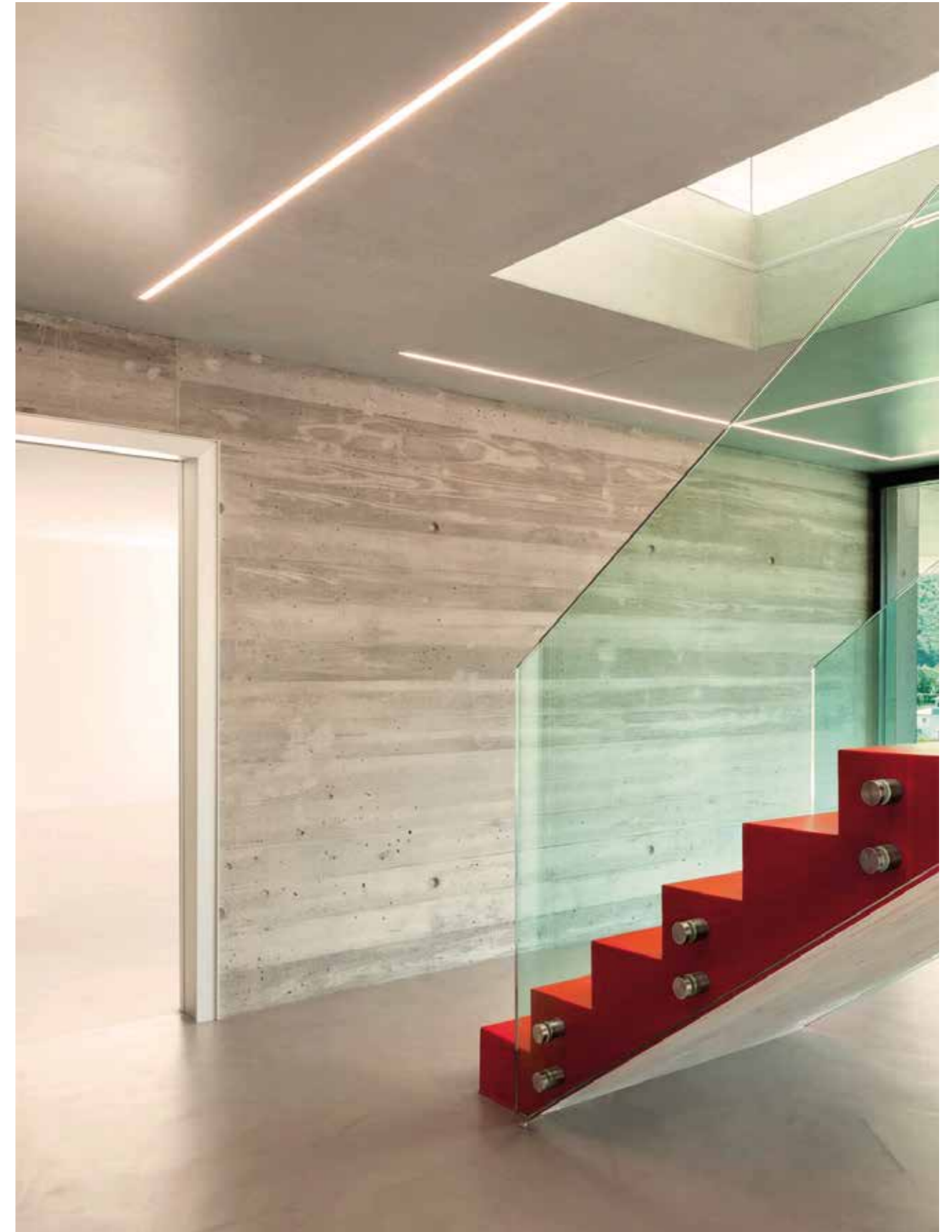

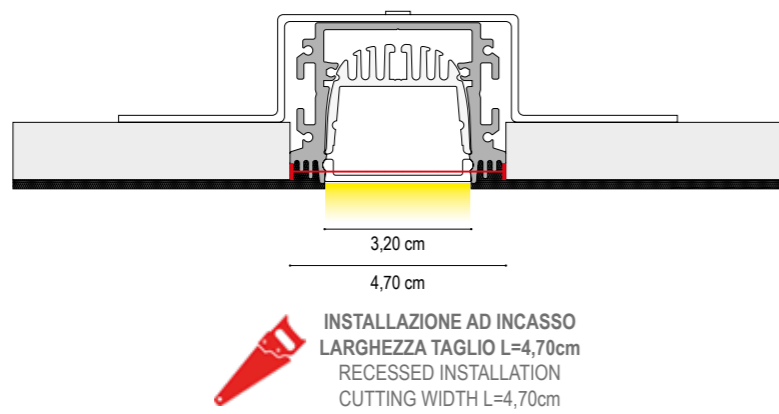

ATTENZIONE! IL PROFILO E' STATO DIMENSIONATO PER UN PANNELLO STANDARD IN CARTONGESSO DI SPESSORE 12,5 mm
WARNING! THE PROFILE HAS BEEN SIZED FOR A STANDARD PLASTERBOARD PANEL OF 12.5 mm THICKNESS

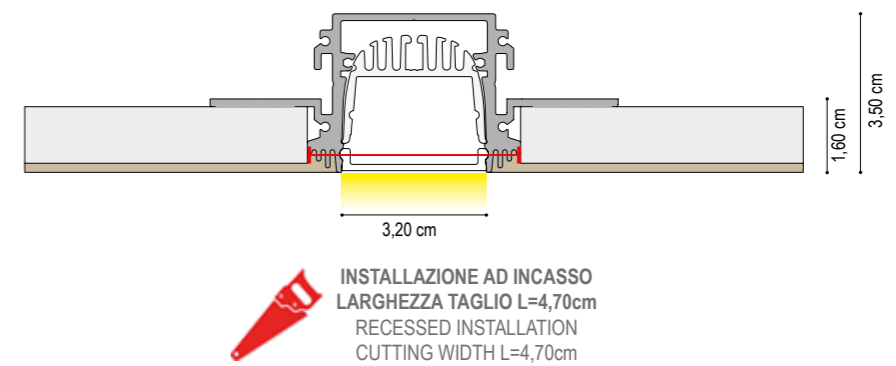

ATTENZIONE! IL PROFILO E' STATO DIMENSIONATO PER UN PANNELLO STANDARD IN CARTONGESSO DI SPESSORE 12,5 mm
WARNING! THE PROFILE HAS BEEN SIZED FOR A STANDARD PLASTERBOARD PANEL OF 12.5 mm THICKNESS

zero35 t

led integrato

integrated led

DATI TECNICI
TECHNICAL DATA

COVER POSA IN OPERA INCLUSA
(COVER MONOUSO PER PROTEGGERE
IL PROFILO DURANTE LE FASI DI
INSTALLAZIONE)

COVER INSTALLED IS INCLUDED
(DISPOSABLE COVER TO PROTECT
THE PROFILE DURING THE INSTALLA-
TION PHASES)

TESTATE NON INCLUDE
DEAD ENDS NOT INCLUDED

	1 cm	200 cm	300 cm
LED Flux Tot:	2200 lm/m	4400 lm	6600 lm
Flux Tot:	1680 lm/m	3360 lm	5040 lm
Output:	110 lm/W	110 lm/W	110 lm/W
CCT:	3000 K	3000 K	3000 K
CRI:	>90	>90	>90
Power Tot:	20.0 W/m	40.0 W	60.0 W
Weight:	0.90 Kg/m	1.80 Kg	2.70 Kg

Profilo/Profile: Alluminio/aluminum

Cover: Opale/opal

FINITURA STRUTTURA FINISHES	DIFFUSORE DIFFUSER	1 cm CODICE CODE	200 cm CODICE CODE	300 cm CODICE CODE
ALLUMINIO NATURALE/ALUMINUM	OPALE/OPAL	2247060001	2247060200	2247060300

COVER POSA IN OPERA INCLUSA
(COVER MONOUSO PER PROTEGGERE
IL PROFILO DURANTE LE FASI DI
INSTALLAZIONE)

COVER INSTALLED IS INCLUDED
(DISPOSABLE COVER TO PROTECT
THE PROFILE DURING THE INSTALLA-
TION PHASES)

TESTATE NON INCLUDE
DEAD ENDS NOT INCLUDED

DATI TECNICI
TECHNICAL DATA

	1 cm
LED Flux Tot:	2520 lm/m
Flux Tot:	2016 lm/m
Output:	105 lm/W
CCT:	3000 K
CRI:	>90
Power Tot:	23.0 W/m
Weight:	0.90 Kg/m

Profilo/Profile: Alluminio/aluminum

Cover: Opale/opal

FINITURA STRUTTURA FINISHES	DIFFUSORE DIFFUSER	2700K 1 cm CODICE CODE	3000K 1 cm CODICE CODE	4000K 1 cm CODICE CODE
ALLUMINIO NATURALE/ALUMINUM	OPALE/OPAL	22H6060001	22H7060001	22H8060001

COVER POSA IN OPERA INCLUSA
(COVER MONOUSO PER PROTEGGERE
IL PROFILO DURANTE LE FASI DI
INSTALLAZIONE)

COVER INSTALLED IS INCLUDED
(DISPOSABLE COVER TO PROTECT
THE PROFILE DURING THE INSTALLA-
TION PHASES)

TESTATE NON INCLUDE
DEAD ENDS NOT INCLUDED

DATI TECNICI
TECHNICAL DATA

	1 cm	200 cm	300 cm
LED Flux Tot:	4440 lm/m	8880 lm	13320 lm
Flux Tot:	3552 lm/m	7104 lm	10656 lm
Output:	148 lm/W	148 lm/W	148 lm/W
CCT:	3000 K	3000 K	3000 K
CRI:	>90	>90	>90
Power Tot:	30.0 W/m	60.0 W	90.0 W
Weight:	0.90 Kg/m	1.80 Kg	2.70 Kg

Profilo/Profile: Alluminio/aluminum

Cover: Opale/opal

FINITURA STRUTTURA FINISHES	DIFFUSORE DIFFUSER	1 cm CODICE CODE	200 cm CODICE CODE	300 cm CODICE CODE
ALLUMINIO NATURALE/ALUMINUM	OPALE/OPAL	2281060001	2281060200	2281060300

zero35 t

led integrato

integrated led

DATI TECNICI
TECHNICAL DATA

COVER POSA IN OPERA INCLUSA
(COVER MONOUSO PER PROTEGGERE
IL PROFILO DURANTE LE FASI DI INSTAL-
LAZIONE)

COVER INSTALLED IS INCLUDED
(DISPOSABLE COVER TO PROTECT THE
PROFILE DURING THE INSTALLATION
PHASES)

TESTATE NON INCLUDE
DEAD ENDS NOT INCLUDED

	1 cm	200 cm	300 cm
LED Flux Tot:	2200 lm/m	4400 lm	6600 lm
Flux Tot:	1680 lm/m	3360 lm	5040 lm
Output:	110 lm/W	110 lm/W	110 lm/W
CCT:	3000 K	3000 K	3000 K
CRI:	>90	>90	>90
Power Tot:	20.0 W/m	40.0 W	60.0 W
Weight:	0.90 Kg/m	1.80 Kg	2.70 Kg

Profilo/Profile: Alluminio/aluminum

Cover: Prismatizzato/prismatic

FINITURA STRUTTURA FINISHES	DIFFUSORE DIFFUSER	1 cm CODICE CODE	200 cm CODICE CODE	300 cm CODICE CODE
ALLUMINIO NATURALE/ALUMINUM	PRISMATIZZATO PRISMATIC	2247060031	2247060231	2247060331

COVER POSA IN OPERA INCLUSA
(COVER MONOUSO PER PROTEGGERE
IL PROFILO DURANTE LE FASI DI INSTAL-
LAZIONE)

COVER INSTALLED IS INCLUDED
(DISPOSABLE COVER TO PROTECT THE
PROFILE DURING THE INSTALLATION
PHASES)

TESTATE NON INCLUDE
DEAD ENDS NOT INCLUDED

DATI TECNICI
TECHNICAL DATA

	1 cm
LED Flux Tot:	2520 lm/m
Flux Tot:	2016 lm/m
Output:	105 lm/W
CCT:	3000 K
CRI:	>90
Power Tot:	23.0 W/m
Weight:	0.90 Kg/m

Profilo/Profile: Alluminio/aluminum

Cover: Prismatizzato/prismatic

FINITURA STRUTTURA FINISHES	DIFFUSORE DIFFUSER	2700K 1 cm CODICE CODE	3000K 1 cm CODICE CODE	4000K 1 cm CODICE CODE
ALLUMINIO NATURALE/ALUMINUM	PRISMATIZZATO PRISMATIC	22H6060031	22H7060031	22H8060031

COVER POSA IN OPERA INCLUSA
(COVER MONOUSO PER PROTEGGERE
IL PROFILO DURANTE LE FASI DI INSTAL-
LAZIONE)

COVER INSTALLED IS INCLUDED
(DISPOSABLE COVER TO PROTECT THE
PROFILE DURING THE INSTALLATION
PHASES)

TESTATE NON INCLUDE
DEAD ENDS NOT INCLUDED

DATI TECNICI
TECHNICAL DATA

	1 cm	200 cm	300 cm
LED Flux Tot:	4440 lm/m	8880 lm	13320 lm
Flux Tot:	3552 lm/m	7104 lm	10656 lm
Output:	148 lm/W	148 lm/W	148 lm/W
CCT:	3000 K	3000 K	3000 K
CRI:	>90	>90	>90
Power Tot:	30.0 W/m	60.0 W	90.0 W
Weight:	0.90 Kg/m	1.80 Kg	2.70 Kg

Profilo/Profile: Alluminio/aluminum

Cover: Prismatizzato/prismatic

FINITURA STRUTTURA FINISHES	DIFFUSORE DIFFUSER	1 cm CODICE CODE	200 cm CODICE CODE	300 cm CODICE CODE
ALLUMINIO NATURALE/ALUMINUM	PRISMATIZZATO PRISMATIC	2281060031	2281060231	2281060331



zero35 t



Profilo in alluminio
Profile in aluminum

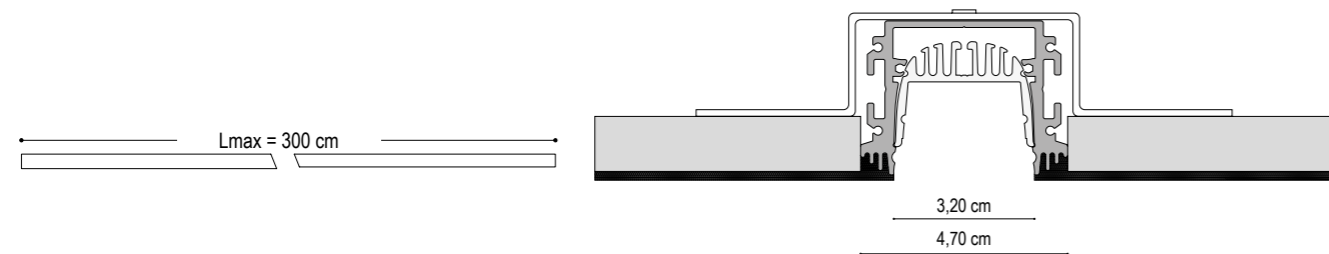

LED compatibili / LED compatibility

HIGH QUALITY CRI>90 CRI>95	HIGH OUTPUT CRI>90 CRI>95	HIGH EFFICIENT CRI>90 CRI>95	HIGH INTENSITY CRI>90 CRI>95	LOW POWER CRI>90	ULTRA SLIM CRI>90 CRI>95 CRI>97	RGB	RGB WHITE	RGB TW	TUNABLE WHITE
9,6W 14,4W 19,2W	12,3W 14,4W 19,2W 20W 24W	12,3W 14,4W 19,2W 20W 24W	24W 24W (700 LED)	6W	9,6W 12W 14,4W	14W	14W	14,4W 23W	19,2W

zero35 t

profilo

profile

	1 cm	200 cm	300 cm
FINITURA STRUTTURA FINISHES	CODICE CODE	CODICE CODE	CODICE CODE
ALLUMINIO NATURALE/ALUMINUM	2203060031	2203060231	2203060331

COVER POSA IN OPERA INCLUSA (COVER MONOUSO PER PROTEGGERE IL PROFILO DURANTE LE FASI DI INSTALLAZIONE)

COVER INSTALLED IS INCLUDED (DISPOSABLE COVER TO PROTECT THE PROFILE DURING THE INSTALLATION PHASES)

DIFFUSORE

	1 cm	200 cm	300 cm
DIFFUSORE DIFFUSER	CODICE CODE	CODICE CODE	CODICE CODE
OPALE/OPAL	1100100001	1100100200	1100100300
SATINATA/SATIN	1100101001	1100101200	1100101300
PRISMATIZZATO/PRISMATIC	1100103001	1100103200	1100103300

COVER ALLUMINIO / ALUMINUM COVER



SEZIONE/SECTION

	1 cm	1 cm	
FINITURA STRUTTURA FINISHES	CODICE CODE	FINITURA STRUTTURA FINISHES	CODICE CODE
GRIGIO VESUVIO/ANTHRACITE	1100500001	ARAMEN COPPER	1100510001
ARGILLA CLAY	1100501001	GRIGIO AVIO/GREY AVIO	1100511001
ARGENTO OPACO/MATT SILVER	1100502001	ARGENTO COMETA/SILVER COMET	1100512001
BIANCO INTONACO/WHITE	1100503001	OTTONE VENEZIANO/BRASS	1100513001
NERO CARAVAGGIO/BLACK	1100504001	TITANIO/TITANIUM	1100514001
MOKA MOCHA	1100505001	BRONZO RIACI/RIACI BRONZE	1100515001
CROMO/CHROME	1100508001	VERDE COSTA/GREEN COAST	1100516001
ORO CALIFORNIA/GOLD	1100509001	TERRA SENESE/SENESE EARTH	1100517001



zero35 m

led integrato

integrated led

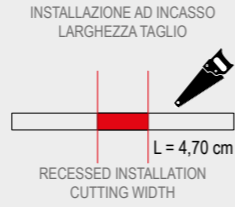
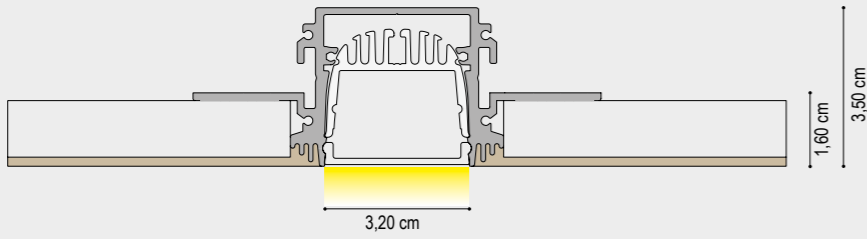

ATTENZIONE! IL PROFILO E' STATO DIMENSIONATO PER UN PANNELLO STANDARD IN CARTONGESSO DI SPESSORE 12,5 mm
WARNING! THE PROFILE HAS BEEN SIZED FOR A STANDARD PLASTERBOARD PANEL OF 12.5 mm THICKNESS

COVER POSA IN OPERA INCLUSA
(COVER MONOUSO PER PROTEGGERE IL PROFILO DURANTE LE FASI DI INSTALLAZIONE)

COVER INSTALLED IS INCLUDED
(DISPOSABLE COVER TO PROTECT THE PROFILE DURING THE INSTALLATION PHASES)

TESTATE NON INCLUDE
DEAD ENDS NOT INCLUDED

DATI TECNICI
TECHNICAL DATA

	1 cm	200 cm	300 cm
LED Flux Tot:	3150 lm/m	6300 lm	9450 lm
Flux Tot:	2520 lm/m	5040 lm	7560 lm
Output:	105 lm/W	105 lm/W	105 lm/W
CCT:	3000 K	3000 K	3000 K
CRI:	>90	>90	>90
Power Tot:	30.0 W/m	60.0 W	90.0 W
Weight:	0.90 Kg/m	1.80 Kg	2.70 Kg
Profilo/Profile:	Alluminio/aluminum		Cover: Opale/opal

FINITURA STRUTTURA FINISHES	DIFFUSORE DIFFUSER	1 cm	200 cm	300 cm
		CODICE CODE	CODICE CODE	CODICE CODE
ALLUMINIO NATURALE/ALUMINUM	OPALE/OPAL	228106M001	228106M200	228106M300

COVER POSA IN OPERA INCLUSA
(COVER MONOUSO PER PROTEGGERE IL PROFILO DURANTE LE FASI DI INSTALLAZIONE)

COVER INSTALLED IS INCLUDED
(DISPOSABLE COVER TO PROTECT THE PROFILE DURING THE INSTALLATION PHASES)

TESTATE NON INCLUDE
DEAD ENDS NOT INCLUDED

DATI TECNICI
TECHNICAL DATA

	1 cm	200 cm	300 cm
LED Flux Tot:	3150 lm/m	6300 lm	9450 lm
Flux Tot:	2520 lm/m	5040 lm	7560 lm
Output:	105 lm/W	105 lm/W	105 lm/W
CCT:	3000 K	3000 K	3000 K
CRI:	>90	>90	>90
Power Tot:	30.0 W/m	60.0 W	90.0 W
Weight:	0.90 Kg/m	1.80 Kg	2.70 Kg
Profilo/Profile:	Alluminio/aluminum		Cover: Prismatico/prismatic

FINITURA STRUTTURA FINISHES	DIFFUSORE DIFFUSER	1 cm	200 cm	300 cm
		CODICE CODE	CODICE CODE	CODICE CODE
ALLUMINIO NATURALE/ALUMINUM	PRISMATIZZATO PRISMATIC	228106M031	228106M231	228106M331

zero35 m

profilo e cover

profile and diffuser

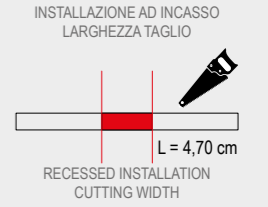
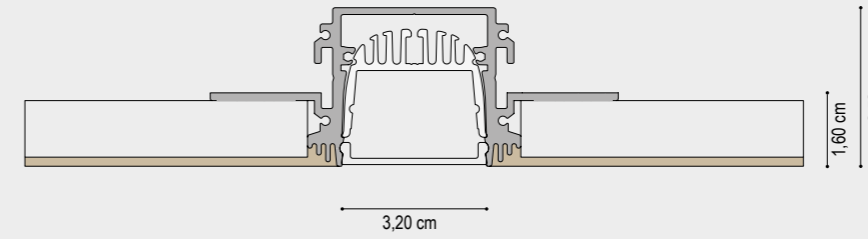

ATTENZIONE! IL PROFILO E' STATO DIMENSIONATO PER UN PANNELLO STANDARD IN CARTONGESSO DI SPESSORE 12,5 mm
WARNING! THE PROFILE HAS BEEN SIZED FOR A STANDARD PLASTERBOARD PANEL OF 12.5 mm THICKNESS

COVER POSA IN OPERA INCLUSA
(COVER MONOUSO PER PROTEGGERE IL PROFILO DURANTE LE FASI DI INSTALLAZIONE)

COVER INSTALLED IS INCLUDED
(DISPOSABLE COVER TO PROTECT THE PROFILE DURING THE INSTALLATION PHASES)

TESTATE NON INCLUDE
DEAD ENDS NOT INCLUDED

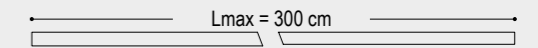

FINITURA STRUTTURA FINISHES	DIFFUSORE DIFFUSER	1 cm	200 cm	300 cm
		CODICE CODE	CODICE CODE	CODICE CODE
ALLUMINIO NATURALE/ALUMINUM	OPALE/OPAL	22CP06M001	22CP06M200	22CP06M300

COVER POSA IN OPERA INCLUSA
(COVER MONOUSO PER PROTEGGERE IL PROFILO DURANTE LE FASI DI INSTALLAZIONE)

COVER INSTALLED IS INCLUDED
(DISPOSABLE COVER TO PROTECT THE PROFILE DURING THE INSTALLATION PHASES)

TESTATE NON INCLUDE
DEAD ENDS NOT INCLUDED

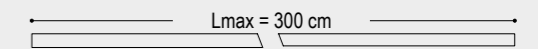

FINITURA STRUTTURA FINISHES	DIFFUSORE DIFFUSER	1 cm	200 cm	300 cm
		CODICE CODE	CODICE CODE	CODICE CODE
ALLUMINIO NATURALE/ALUMINUM	PRISMATIZZATO PRISMATIC	22CR06M001	22CR06M200	22CR06M300



TESTATE DI CHIUSURA / DEAD ENDS



FINITURA STRUTTURA
FINISHES

ALLUMINIO NATURALE/ALUMINUM

CODICE
CODE

220406

Nel codice sono comprese le viti per il fissaggio delle testate al profilo. Il codice contiene n° 1 testate di chiusura.
The code includes the screws for fixing the heads to the profile. The code contains 1 closing warheads

STAFFA DI FISSAGGIO A CARTONGESSO / MOUNTING CLIP FOR PLASTERBOARD

Accessorio che consente l'incasso del profilo.
Accessory that allows the collection of the profile

Nel codice sono comprese le viti per il fissaggio del profilo alla staffa.
The code includes screws for fixing the profile to the bracket

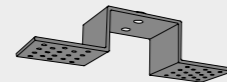

FINITURA
FINISHES

ALLUMINIO NATURALE/ALUMINUM

CODICE
CODE

220502

GIUNTI / JOINTS

GIUNTO LINEA CONTINUA / STRAIGHT JOINT

Accessorio per giunzioni meccaniche lineari
Accessory for linear mechanical joints

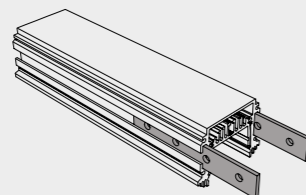

FINITURA
FINISHES

ALLUMINIO NATURALE/ALUMINUM

CODICE
CODE

220503

GIUNTO 90° ORIZZONTALE / HORIZONTAL JOINT 90°

Accessorio per giunzioni meccaniche con angolo 90°
Accessory for linear mechanical joints with 90° angle

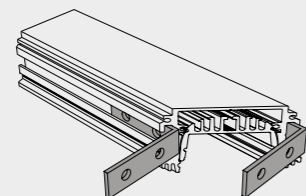

ALLUMINIO NATURALE/ALUMINUM

220500

GIUNTO 90° VERTICALE / VERTICAL JOINT 90°

Accessorio per giunzioni meccaniche con angolo 90°
Accessory for linear mechanical joints with 90° angle

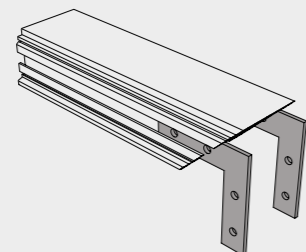

ALLUMINIO NATURALE/ALUMINUM

220501

ATTENZIONE: IL CODICE COMPRENDE N°1 GIUNTO MECCANICO. L'IMMAGINE È A SCOPO ILLUSTRATIVO.
ATTENTION: THE CODE INCLUDES N° 1 MECHANICAL JOINT. THE IMAGE IS FOR ILLUSTRATIVE PURPOSE.
Nel codice sono compresi i grani per il fissaggio del giunto / The code includes the grains for fixing the joint.

LAVORAZIONI / PROCESSING

DATI TECNICI
TECHNICAL DATA

CODICE
CODE

TAGLIO 90° ORIZZONTALE (PER ANGOLI FORMATI DA DUE PROFILI)
HORIZONTAL 90 ° CUT (FOR CORNERS MADE OF TWO PROFILES)

190X



TAGLIO 90° VERTICALE (PER ANGOLI FORMATI DA DUE PROFILI)
VERTICAL 90 ° CUT (FOR CORNERS MADE OF TWO PROFILES)

190Y

TAGLIO ANGOLARE CUSTOM (PER ANGOLI FORMATI DA DUE PROFILI)
CUSTOM CORNER CUT (FOR CORNERS MADE OF TWO PROFILES)

190N



ASOLA / SLOT

100A

ASOLA CUSTOM / SLOTCUSTOM

100N

FORO / HOLE

100F



CABLAGGIO - COLLAUDO - CE AL CENTIMETRO
INSTALLATION AND TESTING LED MODULE AT CENTIMETER

2201



CONNETTORE MASCHIO/FEMMINA
MALE/FEMALE CONNECTOR

98CFM

CONNETTORE MASCHIO/FEMMINA MONTATO NEL PRODOTTO
MALE/FEMALE CONNECTOR FITTED IN THE PRODUCT

98MFM



CAVO DI ALIMENTAZIONE 2X0,75 TONDO TRASPARENTE 1CM
POWER CABLE 2X0,75 ROUND TRANSPARENT 1CM

98CTT001



“zero65 di luce diretta zero65 x di luce diretta e indiretta”

Il progetto ZERO65 nasce dall'esigenza di integrare le alimentazioni in un progetto, offre soluzioni innovative in ogni sua fase; dalla progettazione alla messa in opera, senza tra l'altro tralasciare l'aspetto illuminotecnico le cui tecniche sono indispensabili a garantire una luce diffusa o puntuale. Capaci, quindi, di generale flussi luminosi che trasmettano emozioni e calore in grado di aumentare il rapporto di benessere tra le persone e l'ambiente. Può essere installato da incasso a parete, plafone o sospensione i tagli su misura e a 45 gradi, le diverse finiture lo rendono estremamente flessibile.

ZERO65 with and without border is born on basis of need to include power supplies in a project. Offers innovative solutions in each phase of the project, beginning with the planning until the end with the installation and never leave out the lighting aspect, which's technology offers bright or spot light. Able to create emotional and warm illumination flows which increases the relationship between persons and environment. It can be installed like wall recessed, surface mounted or pendant. The customized lengths, the 45°cuts and the different colours makes it very flexible.



zero65 +065 x

zero65 +065 x

configurazioni

configurations

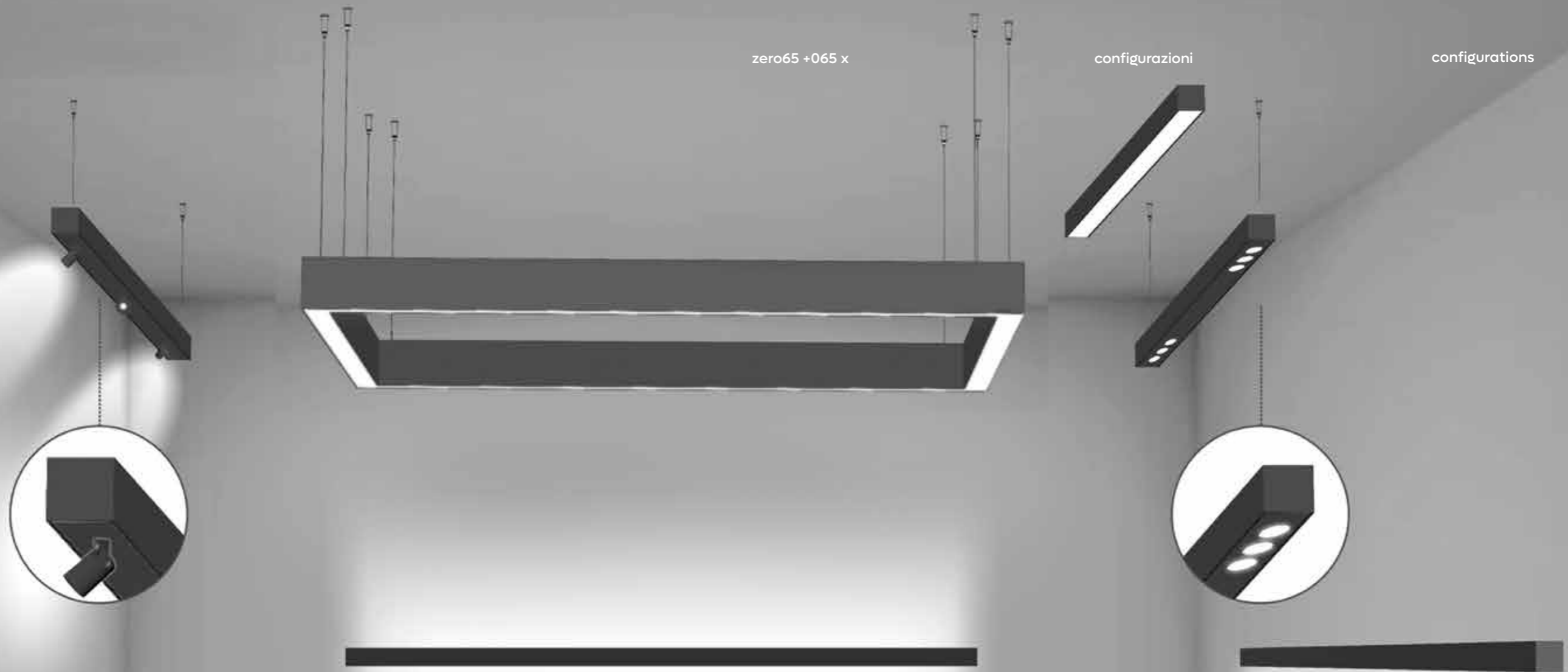

LE COMPOSIZIONI SOPRA RIPORTATE POSSONO ESSERE REALIZZATE PER INSTALLAZIONE A SOSPENSIONE / SOFFITTO-PARETE / INCASSO.
PER LE COMPOSIZIONI POLIGONALI RIVOLGERSI AL NOSTRO REPARTO TECNICO.

THE ABOVE COMPOSITIONS CAN BE MADE FOR SUSPENSION / CEILING-WALL / RECESSED INSTALLATION.
FOR POLYGONAL COMPOSITIONS, PLEASE CONTACT OUR TECHNICAL DEPARTMENT.

IL FISSAGGIO A SUPERFICIE NON PREVEDE UTILIZZO DI ACCESSORI. IL PRODOTTO ZER035 SI INSTALLA A SUPERFICIE MEDIANTE UTILIZZO DI TASSELLI IDONEI AL TIPO DI MURATURA E FORANDO IL PROFILO ESTERNO IN ALLUMINIO. LA FORATURA DEL PROFILO PUÒ ESSERE RICHIESTA UTILIZZANDO IL CODICE 100F.

SURFACE MOUNTING DOES NOT INCLUDE THE USE OF ACCESSORIES. THE ZER035 PRODUCT IS INSTALLED ON THE SURFACE BY USING DOWELS SUITABLE FOR THE TYPE OF MASONRY AND DRILLING THE EXTERNAL ALUMINUM PROFILE. PROFILE DRILLING CAN BE REQUIRED USING CODE 100F.

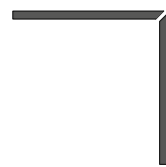

A. COMPOSIZIONE ANGOLARE A "L"
A. L-ANGLE COMPOSITION

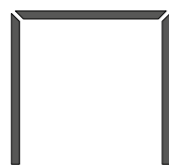

B. COMPOSIZIONE ANGOLARE A "C"
B. C-ANGLE COMPOSITION

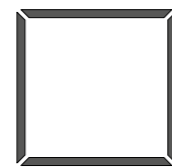

C. COMPOSIZIONE POLIGONALE (QUADRATO/RETTANGOLO)
C. POLYGONAL COMPOSITION (SQUARE / RECTANGLE)



D. COMPOSIZIONE POLIGONALE (PENTAGONO/ESAGONO)
D. POLYGONAL COMPOSITION (PENTAGON / HEX)

INSTALLAZIONE A SOSPENSIONE
SUSPENSION

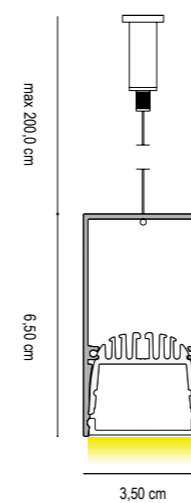

INSTALLAZIONE A SOFFITTO
CEILING INSTALLATION

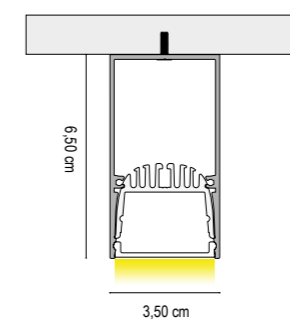

INSTALLAZIONE A INCASSO IN CARTONGESSO
RECESSED INSTALLATION IN PLASTERBOARD

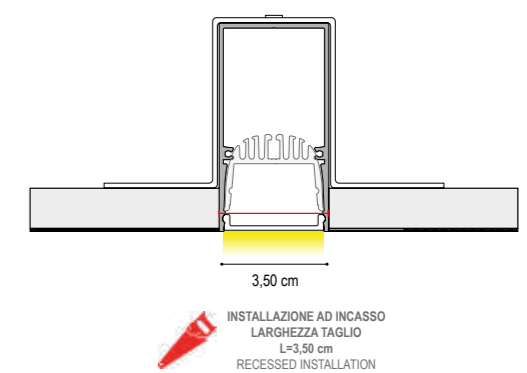

ATTENZIONE! GLI ACCESSORI PER L'INSTALLAZIONE A INCASSO SONO STATI DIMENSIONATI PER UN PANNELLO STANDARD IN CARTONGESSO DI SPESSORE 12,5 mm
WARNING! THE BUILT-IN INSTALLATION ACCESSORIES HAVE BEEN DIMENSIONED FOR A STANDARD PLASTERBOARD PANEL OF 12.5 mm THICKNESS

zero65

led integrato

integrated led

zero65

led integrato

integrated led

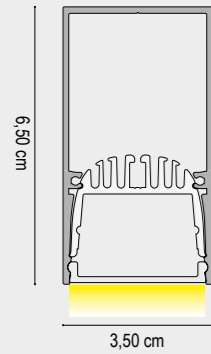

DATI TECNICI
TECHNICAL DATA

	1 cm	200 cm	300 cm
Nominal LED Flux:	2200 lm/m	4400 lm	6600 lm
Flux Tot:	1680 lm/m	3360 lm	5040 lm
Output:	105 lm/W	105 lm/W	105 lm/W
CCT:	3000 K	3000 K	3000 K
CRI:	>90	>90	>90
Power Tot:	20.0 W/m	40.0 W	60.0 W
Weight:	0.90 Kg/m	1.80 Kg	2.70 Kg

Profilo/Profile: Alluminio/aluminum

Cover: Opale/opal

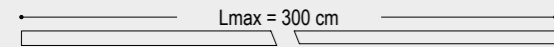

CAVO ALIMENTAZIONE: 50 cm
ALIMENTATION CABLE: 50 cm

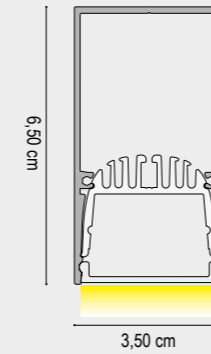

DATI TECNICI
TECHNICAL DATA

	1 cm	200 cm	300 cm
Nominal LED Flux:	2520 lm/m	5040 lm	7560 lm
Flux Tot:	2016 lm/m	4032 lm	6048 lm
Output:	105 lm/W	105 lm/W	105 lm/W
CCT:	3000 K	3000 K	3000 K
CRI:	>90	>90	>90
Power Tot:	23.0 W/m	46.0 W	69.0 W
Weight:	0.90 Kg/m	1.80 Kg	2.70 Kg

Profilo/Profile: Alluminio/aluminum

Cover: Opale/opal

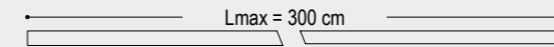

CAVO ALIMENTAZIONE: 50 cm
ALIMENTATION CABLE: 50 cm

FINITURA STRUTTURA FINISHES	DIFFUSORE DIFFUSER	1 cm	200 cm	300 cm
		DRIVER NON INCLUSO NOT INCLUDED	DRIVER ON/OFF INCLUSO INCLUDED	DRIVER ON/OFF INCLUSO INCLUDED
GRIGIO VESUVIO ANTHRACITE	OPALE/OPAL	1114700001	1114700200	1114700300
ARGILLA CLAY		1114701001	1114701200	1114701300
ARGENTO OPACO/MATT SILVER		1114702001	1114702200	1114702300
BIANCO INTONACO/WHITE		1114703001	1114703200	1114703300
NERO CARAVAGGIO BLACK		1114704001	1114704200	1114704300
MOKA MOCHA		1114705001	1114705200	1114705300
ORO CALIFORNIA/GOLD		1114709001	1114709200	1114709300
ARAMEN COPPER		1114710001	1114710200	1114710300
GRIGIO AVIO/GREY AVIO		1114711001	1114711200	1114711300
ARGENTO COMETA/SILVER COMET		1114712001	1114712200	1114712300
OTTONE VENEZIANO/BRASS		1114713001	1114713200	1114713300
TITANIO/TITANIUM		1114714001	1114714200	1114714300
BRONZO RIACI/RIACI BRONZE		1114715001	1114715200	1114715300
VERDE COSTA/GREEN COAST		1114716001	1114716200	1114716300
TERRA SENESE SENESE EARTH		1114717001	1114717200	1114717300
CROMO/CHROME		1114708001	1114708200	

N.B./P.N.:

LUNGHEZZA MASSIMA VERSIONE CROMO = 2,00 m / MAXIMUM LENGTH CHROME VERSION = 2.00 m
TESTATE DI CHIUSURA NON INCLUSA / DEAD ENDS NOT INCLUDED

FINITURA STRUTTURA FINISHES	DIFFUSORE DIFFUSER	1 cm	200 cm	300 cm
		DRIVER NON INCLUSO NOT INCLUDED	DRIVER ON/OFF INCLUSO INCLUDED	DRIVER ON/OFF INCLUSO INCLUDED
GRIGIO VESUVIO ANTHRACITE	OPALE/OPAL	111H700001	111H700200	111H700300
ARGILLA CLAY		111H701001	111H701200	111H701300
ARGENTO OPACO/MATT SILVER		111H702001	111H702200	111H702300
BIANCO INTONACO/WHITE		111H703001	111H703200	111H703300
NERO CARAVAGGIO BLACK		111H704001	111H704200	111H704300
MOKA MOCHA		111H705001	111H705200	111H705300
ORO CALIFORNIA/GOLD		111H709001	111H709200	111H709300
ARAMEN COPPER		111H710001	111H710200	111H710300
GRIGIO AVIO/GREY AVIO		111H711001	111H711200	111H711300
ARGENTO COMETA/SILVER COMET		111H712001	111H712200	111H712300
OTTONE VENEZIANO/BRASS		111H713001	111H713200	111H713300
TITANIO/TITANIUM		111H714001	111H714200	111H714300
BRONZO RIACI/RIACI BRONZE		111H715001	111H715200	111H715300
VERDE COSTA/GREEN COAST		111H716001	111H716200	111H716300
TERRA SENESE SENESE EARTH		111H717001	111H717200	111H717300
CROMO/CHROME		111H708001	111H708200	

N.B./P.N.:

LUNGHEZZA MASSIMA VERSIONE CROMO = 2,00 m / MAXIMUM LENGTH CHROME VERSION = 2.00 m
TESTATE DI CHIUSURA NON INCLUSA / DEAD ENDS NOT INCLUDED



zero65

led integrato

integrated led

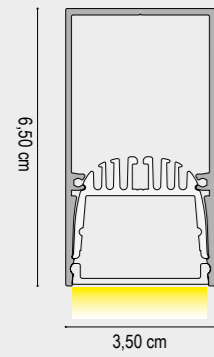

DATI TECNICI
TECHNICAL DATA

	1 cm	200 cm	300 cm
Nominal LED Flux:	4440 lm/m	8880 lm	13320 lm
Flux Tot:	3552 lm/m	7104 lm	10656 lm
Output:	148 lm/W	148 lm/W	148 lm/W
CCT:	3000 K	3000 K	3000 K
CRI:	>90	>90	>90
Power Tot:	30.0 W/m	60.0 W	90.0 W
Weight:	0.90 Kg/m	1.80 Kg	2.70 Kg

Profilo/Profile: Alluminio/aluminum

Cover: Opale/opal

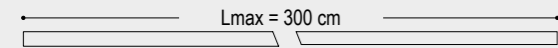

CAVO ALIMENTAZIONE: 50 cm
ALIMENTATION CABLE: 50 cm

zero65 — ugr<19

led integrato

integrated led

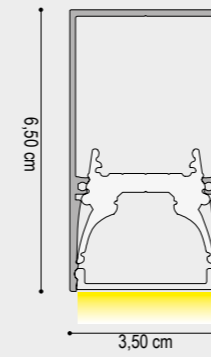

DATI TECNICI
TECHNICAL DATA

	1 cm	200 cm	300 cm
Nominal LED Flux:	4440 lm/m	8880 lm	13320 lm
Flux Tot:	3552 lm/m	7104 lm	10656 lm
Output:	148 lm/W	148 lm/W	148 lm/W
CCT:	3000 K	3000 K	3000 K
CRI:	>90	>90	>90
Power Tot:	30.0 W/m	60.0 W	90.0 W
Weight:	0.90 Kg/m	1.80 Kg	2.70 Kg

Profilo/Profile: Alluminio/aluminum

Cover: Prismatico/prismatic

CAVO ALIMENTAZIONE: 50 cm
ALIMENTATION CABLE: 50 cm

		1 cm	200 cm	300 cm
		DRIVER NON INCLUSO NOT INCLUDED	DRIVER ON/OFF INCLUSO INCLUDED	DRIVER ON/OFF INCLUSO INCLUDED
FINITURA STRUTTURA FINISHES	DIFFUSORE DIFFUSER	CODICE CODE	CODICE CODE	CODICE CODE
GRIGIO VESUVIO ANTHRACITE	OPALE/OPAL	1118100001	1118100200	1118100300
ARGILLA CLAY		1118101001	1118101200	1118101300
ARGENTO OPACO/MATT SILVER		1118102001	1118102200	1118102300
BIANCO INTONACO/WHITE		1118103001	1118103200	1118103300
NERO CARAVAGGIO BLACK		1118104001	1118104200	1118104300
MOKA MOCHA		1118105001	1118105200	1118105300
ORO CALIFORNIA/GOLD		1118109001	1118109200	1118109300
ARAMEN COPPER		1118110001	1118110200	1118110300
GRIGIO AVIO/GREY AVIO		1118111001	1118111200	1118111300
ARGENTO COMETA/SILVER COMET		1118112001	1118112200	1118112300
OTTONE VENEZIANO BRASS		1118113001	1118113200	1118113300
TITANIO/TITANIUM		1118114001	1118114200	1118114300
BRONZO RIACI/RIACI BRONZE		1118115001	1118115200	1118115300
VERDE COSTA/GREEN COAST		1118116001	1118116200	1118116300
TERRA SENESE/SENESE EARTH		1118117001	1118117200	1118117300
CROMO/CHROME		1118108001	1118108200	

N.B./P.N.:
LUNGHEZZA MASSIMA VERSIONE CROMO = 2,00 m / MAXIMUM LENGTH CHROME VERSION = 2.00 m
TESTATE DI CHIUSURA NON INCLUSA / DEAD ENDS NOT INCLUDED

		1 cm	200 cm	300 cm
		DRIVER NON INCLUSO NOT INCLUDED	DRIVER ON/OFF INCLUSO INCLUDED	DRIVER ON/OFF INCLUSO INCLUDED
FINITURA STRUTTURA FINISHES	DIFFUSORE DIFFUSER	CODICE CODE	CODICE CODE	CODICE CODE
GRIGIO VESUVIO ANTHRACITE	PRISMATIZZATO PRISMATIC	1118100031	1118100230	1118100330
ARGILLA CLAY		1118101031	1118101230	1118101330
ARGENTO OPACO/MATT SILVER		1118102031	1118102230	1118102330
BIANCO INTONACO/WHITE		1118103031	1118103230	1118103330
NERO CARAVAGGIO BLACK		1118104031	1118104230	1118104330
MOKA MOCHA		1118105031	1118105230	1118105330
ORO CALIFORNIA/GOLD		1118109031	1118109230	1118109330
ARAMEN COPPER		1118110031	1118110230	1118110330
GRIGIO AVIO/GREY AVIO		1118111031	1118111230	1118111330
ARGENTO COMETA/SILVER COMET		1118112031	1118112230	1118112330
OTTONE VENEZIANO BRASS		1118113031	1118113230	1118113330
TITANIO/TITANIUM		1118114031	1118114230	1118114330
BRONZO RIACI/RIACI BRONZE		1118115031	1118115230	1118115330
VERDE COSTA/GREEN COAST		1118116031	1118116230	1118116330
TERRA SENESE/SENESE EARTH		1118117031	1118117230	1118117330
CROMO/CHROME		1118108031	1118108230	

N.B./P.N.:
LUNGHEZZA MASSIMA VERSIONE CROMO = 2,00 m / MAXIMUM LENGTH CHROME VERSION = 2.00 m
TESTATE DI CHIUSURA NON INCLUSA / DEAD ENDS NOT INCLUDED



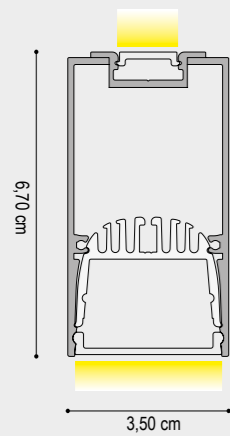

DATI TECNICI
TECHNICAL DATA

	DIFFUSORE ESTERNO / EXTERNAL DIFFUSER		
	1 cm - 40W/m	200 cm - 80W	300 cm - 120W
Nominal LED Flux:	↑ 2200 lm/m - 2200 lm/m ↓	↑ 4400 lm - 4400 lm ↓	↑ 6600 lm - 6600 lm ↓
Flux Tot:	↑ 1890 lm/m - 1680 lm/m ↓	↑ 3780 lm - 3360 lm ↓	↑ 5670 lm - 5040 lm ↓
Output:	110 lm/W	110 lm/W	110 lm/W
CCT:	3000 K	3000 K	3000 K
CRI:	>90	>90	>90
Power:	↑ 20.0W/m - 20.0W/m ↓	↑ 40.0W - 40.0W ↓	↑ 60.0W - 60.0W ↓
Power Tot:	40.0W/m	80.0W	120.0W
Weight:	1.70 Kg/m	3.40 Kg	5.10 Kg

Profilo/Profile: Alluminio/aluminum Cover: Opale/opal - Satinato/Satin

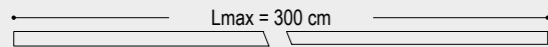

CAVO ALIMENTAZIONE: 50 cm
ALIMENTATION CABLE: 50 cm

FINITURA STRUTTURA
FINISHES

- GRIGIO VESUVIO ANTHRACITE
- ARGILLA CLAY
- ARGENTO OPACO/MATT SILVER
- BIANCO INTONACO/WHITE
- NERO CARAVAGGIO BLACK
- MOKA MOCHA
- ORO CALIFORNIA GOLD
- ARAMEN COPPER
- GRIGIO AVIO/GREY AVIO
- ARGENTO COMETA/SILVER COMET
- OTTONE VENEZIANO BRASS
- TITANIO/TITANIUM
- BRONZO RIACI/RIACI BRONZE
- VERDE COSTA/GREEN COAST
- TERRA SENESE SENESE EARTH
- CROMO/CHROME

DIFFUSORE
DIFFUSER

- SATINATA/SATIN
- OPALE/OPAL

	1 cm	200 cm	300 cm
DRIVER NON INCLUSO NOT INCLUDED	DRIVER ON/OFF INCLUSO INCLUDED	DRIVER ON/OFF INCLUSO INCLUDED	DRIVER ON/OFF INCLUSO INCLUDED
CODICE CODE	CODICE CODE	CODICE CODE	CODICE CODE
1114700011	1114700210	1114700310	1114700310
1114701011	1114701210	1114701310	1114701310
1114702011	1114702210	1114702310	1114702310
1114703011	1114703210	1114703310	1114703310
1114704011	1114704210	1114704310	1114704310
1114705011	1114705210	1114705310	1114705310
1114709011	1114709210	1114709310	1114709310
1114710011	1114710210	1114710310	1114710310
1114711011	1114711210	1114711310	1114711310
1114712011	1114712210	1114712310	1114712310
1114713011	1114713210	1114713310	1114713310
1114714011	1114714210	1114714310	1114714310
1114715011	1114715210	1114715310	1114715310
1114716011	1114716210	1114716310	1114716310
1114717011	1114717210	1114717310	1114717310
1114708011	1114708210		

N.B./P.N.:

LUNGHEZZA MASSIMA VERSIONE CROMO = 2,00 m / MAXIMUM LENGTH CHROME VERSION = 2.00 m
TESTATE DI CHIUSURA NON INCLUSE / DEAD ENDS NOT INCLUDED



TESTATE DI CHIUSURA / DEAD ENDS



FINITURA STRUTTURA FINISHES	CODICE CODE	FINITURA STRUTTURA FINISHES	CODICE CODE
GRIGIO VESUVIO ANTHRACITE	1110400000	ARAMEN COPPER	1110410000
ARGILLA CLAY	1110401000	GRIGIO AVIO/GREY AVIO	1110411000
ARGENTO OPACO/MATT SILVER	1110402000	ARGENTO COMETA/SILVER COMET	1110412000
BIANCO INTONACO/WHITE	1110403000	OTTONE VENEZIANO BRASS	1110413000
NERO CARAVAGGIO BLACK	1110404000	TITANIO/TITANIUM	1110414000
MOKA MOCHA	1110405000	BRONZO RIACI/RIACI BRONZE	1110415000
CROMO/CHROME	1110408000	VERDE COSTA/GREEN COAST	1110416000
ORO CALIFORNIA GOLD	1110409000	TERRA SENESE SENESE EARTH	1110417000

Nel codice sono comprese le viti per il fissaggio delle testate al profilo. Il codice contiene n° 1 testate di chiusura. / The code includes the screws for fixing the heads to the profile. The code contains 1 closing warheads

TESTATE DI CHIUSURA CON LOGO / DEAD ENDS WITH LOGO



FINITURA STRUTTURA FINISHES	CODICE CODE	FINITURA STRUTTURA FINISHES	CODICE CODE
GRIGIO VESUVIO ANTHRACITE	1110600000	GRIGIO AVIO/GREY AVIO	1110611000
ARGILLA CLAY	1110601000	ARGENTO COMETA/SILVER COMET	1110612000
BIANCO INTONACO/WHITE	1110603000	OTTONE VENEZIANO BRASS	1110613000
NERO CARAVAGGIO BLACK	1110604000	TITANIO/TITANIUM	1110614000
MOKA MOCHA	1110605000	BRONZO RIACI/RIACI BRONZE	1110615000
CROMO/CHROME	1110608000	VERDE COSTA/GREEN COAST	1110616000
ORO CALIFORNIA GOLD	1110609000	TERRA SENESE SENESE EARTH	1110617000
ARAMEN COPPER	1110610000		

Nel codice sono comprese le viti per il fissaggio delle testate al profilo. Il codice contiene n° 1 testate di chiusura. / The code includes the screws for fixing the heads to the profile. The code contains 1 closing warheads

KIT DI SOSPENSIONE / SUSPENSION KIT

ARTICOLI INCLUSI NEL CODICE
ARTICLES INCLUDED IN THE CODE

Cavo in acciaio 2,00m con puntalino
2.00m steel cable with tip
Boccola cromata con regolazione millimetrica
Chrome bush with millimeter adjustment

Cavo in acciaio 3,00m con puntalino
3.00m steel cable with tip

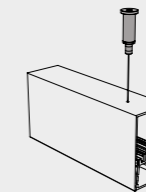

FINITURA
FINISHES

CROMO/CHROME

CODICE
CODE

1110508200

11100508200

LAVORAZIONI / PROCESSING

DATI TECNICI
TECHNICAL DATA

CODICE
CODE

TAGLIO 90° ORIZZONTALE (PER ANGOLI FORMATI DA DUE PROFILI)
HORIZONTAL 90 ° CUT (FOR CORNERS MADE OF TWO PROFILES)

190X

ASOLA / SLOT

100A

ASOLA CUSTOM / 100n CUSTOM SLOT SLOT

100N

FORO / HOLE

100F

CONNETTORE MASCHIO/FEMMINA
MALE/FEMALE CONNECTOR

98CFM

CONNETTORE MASCHIO/FEMMINA MONTATO NEL PRODOTTO
MALE/FEMALE CONNECTOR FITTED IN THE PRODUCT

98MFM

MONTAGGIO CABLAGGIO COLLAUDO CE DRIVER 60W / MOUNTING WIRING TESTING CE MARKING DRIVER 60W

1050A

MONTAGGIO CABLAGGIO COLLAUDO CE DRIVER 96W / MOUNTING WIRING TESTING CE MARKING DRIVER 96W

1096A

MONTAGGIO CABLAGGIO COLLAUDO CE DRIVER DIM 70W / MOUNTING WIRING TESTING CE MARKING DIM DRIVER 70W

1070D

MONTAGGIO CABLAGGIO COLLAUDO CE DRIVER DIM 100W / MOUNTING WIRING TESTING CE MARKING DIM DRIVER DIM 100W

1101D

“costruito in estruso di alluminio”

ZER065-P costruito in estruso di alluminio si avvale della tecnologia degli schermi in policarbonato per diffondere la luce per mezzo di LED al top, per qualità, resa cromatica, lumen emessi, ed accurata selezione della temperatura colore, scelta in base al progetto scenografico che vogliamo ottenere. ZER065-P offre una gamma di finiture e di accessori, i tagli lineari e a 45° o su MISURA, rendono realizzabile qualsiasi progetto a parete.

ZER065-P is made in extruded aluminium. Use polycarbonate technology for diffusing led light with high precision, use high quality like led, colour rendering, lumen output and accurate colour temperature for ensuring optimal results for each type of project. ZER065-P offers a wide gamma of finishing's and accessories, several lengths, 45°cuts or completely customized. With Zer035-P it's possible to realize any kind of wall projects.



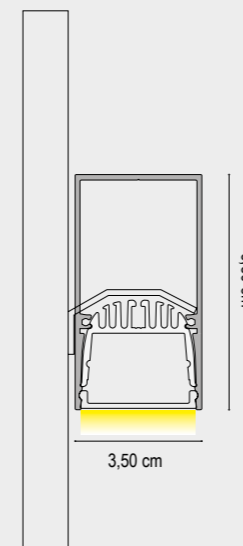

A. COMPOSIZIONE ANGOLARE A "L"
A. L-ANGLE COMPOSITION

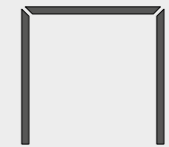

B. COMPOSIZIONE ANGOLARE A "C"
B. C-ANGLE COMPOSITION



C. COMPOSIZIONE POLIGONALE
(QUADRATO/RETTANGOLO)
C. POLYGONAL COMPOSITION
(SQUARE / RECTANGLE)

zero65 p

led integrato

integrated led

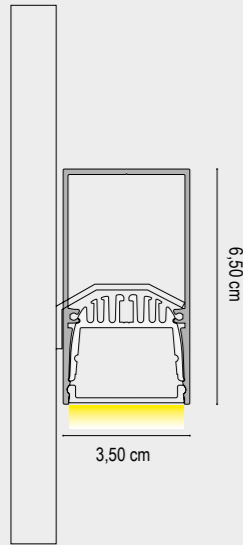

DATI TECNICI
TECHNICAL DATA

	1 cm	200 cm	300 cm
Nominal LED Flux:	2200 lm/m	4400 lm	6600 lm
Flux Tot:	1680 lm/m	3360 lm	5040 lm
Output:	105 lm/W	105 lm/W	105 lm/W
CCT:	3000 K	3000 K	3000 K
CRI:	>90	>90	>90
Power Tot:	20.0 W/m	40.0 W	60.0 W
Weight:	0.90 Kg/m	1.80 Kg	2.70 Kg

Profilo/Profile: Alluminio/aluminum

Cover: Opale/opal

STAFFE DI FISSAGGIO A PARETE INCLUSE NEL CODICE / WALL MOUNTING BRACKETS INCLUDED IN THE CODE
CAVO ALIMENTAZIONE: 50 cm / ALIMENTATION CABLE: 50 cm

zero65 p

led integrato

integrated led

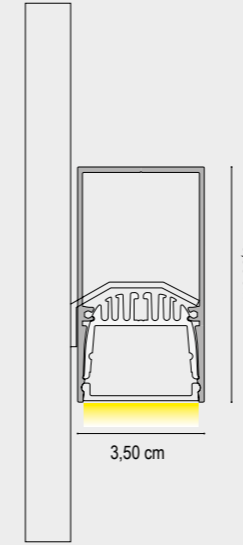

DATI TECNICI
TECHNICAL DATA

	1 cm	200 cm	300 cm
Nominal LED Flux:	2520 lm/m	5040 lm	7560 lm
Flux Tot:	2016 lm/m	4032 lm	6048 lm
Output:	105 lm/W	105 lm/W	105 lm/W
CCT:	3000 K	3000 K	3000 K
CRI:	>90	>90	>90
Power Tot:	23.0 W/m	46.0 W	69.0 W
Weight:	0.90 Kg/m	1.80 Kg	2.70 Kg

Profilo/Profile: Alluminio/aluminum

Cover: Opale/opal

STAFFE DI FISSAGGIO A PARETE INCLUSE NEL CODICE / WALL MOUNTING BRACKETS INCLUDED IN THE CODE
CAVO ALIMENTAZIONE: 50 cm / ALIMENTATION CABLE: 50 cm

		1 cm	200 cm	300 cm
		DRIVER NON INCLUSO / NOT INCLUDED	DRIVER ON/OFF INCLUSO / INCLUDED	DRIVER ON/OFF INCLUSO / INCLUDED
FINITURA STRUTTURA / FINISHES	DIFFUSORE / DIFFUSER	CODICE / CODE	CODICE / CODE	CODICE / CODE
GRIGIO VESUVIO ANTHRACITE	OPALE/OPAL	1114700021	1114700220	1114700320
ARGILLA CLAY		1114701021	1114701220	1114701320
ARGENTO OPACO/MATT SILVER		1114702021	1114702220	1114702320
BIANCO INTONACO/WHITE		1114703021	1114703220	1114703320
NERO CARAVAGGIO BLACK		1114704021	1114704220	1114704320
MOKA MOCHA		1114705021	1114705220	1114705320
ORO CALIFORNIA/GOLD		1114709021	1114709220	1114709320
ARAMEN COPPER		1114710021	1114710220	1114710320
GRIGIO AVIO/GREY AVIO		1114711021	1114711220	1114711320
ARGENTO COMETA/SILVER COMET		1114712021	1114712220	1114712320
OTTONE VENEZIANO BRASS		1114713021	1114713220	1114713320
TITANIO/TITANIUM		1114714021	1114714220	1114714320
BRONZO RIACI/RIACI BRONZE		1114715021	1114715220	1114715320
VERDE COSTA/GREEN COAST		1114716021	1114716220	1114716320
TERRA SENESE SENESE EARTH		1114717021	1114717220	1114717320
CROMO/CHROME	1114708021	1114708220		

N.B./P.N.:
LUNGHEZZA MASSIMA VERSIONE CROMO = 2,00 m / MAXIMUM LENGTH CHROME VERSION = 2.00 m
TESTATE DI CHIUSURA NON INCLUSE / DEAD ENDS NOT INCLUDED

		1 cm	200 cm	300 cm
		DRIVER NON INCLUSO / NOT INCLUDED	DRIVER ON/OFF INCLUSO / INCLUDED	DRIVER ON/OFF INCLUSO / INCLUDED
FINITURA STRUTTURA / FINISHES	DIFFUSORE / DIFFUSER	CODICE / CODE	CODICE / CODE	CODICE / CODE
GRIGIO VESUVIO ANTHRACITE	OPALE/OPAL	111H700021	111H700220	111H700320
ARGILLA CLAY		111H701021	111H701220	111H701320
ARGENTO OPACO/MATT SILVER		111H702021	111H702220	111H702320
BIANCO INTONACO/WHITE		111H703021	111H703220	111H703320
NERO CARAVAGGIO BLACK		111H704021	111H704220	111H704320
MOKA MOCHA		111H705021	111H705220	111H705320
ORO CALIFORNIA/GOLD		111H709021	111H709220	111H709320
ARAMEN COPPER		111H710021	111H710220	111H710320
GRIGIO AVIO/GREY AVIO		111H711021	111H711220	111H711320
ARGENTO COMETA/SILVER COMET		111H712021	111H712220	111H712320
OTTONE VENEZIANO BRASS		111H713021	111H713220	111H713320
TITANIO/TITANIUM		111H714021	111H714220	111H714320
BRONZO RIACI/RIACI BRONZE		111H715021	111H715220	111H715320
VERDE COSTA/GREEN COAST		111H716021	111H716220	111H716320
TERRA SENESE SENESE EARTH		111H717021	111H717220	111H717320
CROMO/CHROME	111H708021	111H708220		

N.B./P.N.:
LUNGHEZZA MASSIMA VERSIONE CROMO = 2,00 m / MAXIMUM LENGTH CHROME VERSION = 2.00 m
TESTATE DI CHIUSURA NON INCLUSE / DEAD ENDS NOT INCLUDED



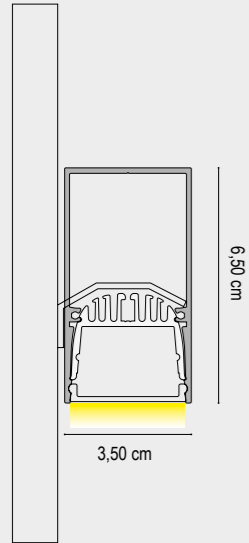

DATI TECNICI
TECHNICAL DATA

	1 cm	200 cm	300 cm
Nominal LED Flux:	2200 lm/m	4400 lm	6600 lm
Flux Tot:	1680 lm/m	3360 lm	5040 lm
Output:	105 lm/W	105 lm/W	105 lm/W
CCT:	3000 K	3000 K	3000 K
CRI:	>90	>90	>90
Power Tot:	20.0 W/m	40.0 W	60.0 W
Weight:	0.90 Kg/m	1.80 Kg	2.70 Kg
Profilo/Profile:	Alluminio/aluminum		Cover: Prismatico/prismatic

STAFFE DI FISSAGGIO A PARETE INCLUSE NEL CODICE / WALL MOUNTING BRACKETS INCLUDED IN THE CODE
CAVO ALIMENTAZIONE: 50 cm / ALIMENTATION CABLE: 50 cm

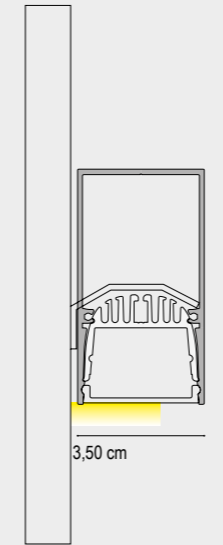

DATI TECNICI
TECHNICAL DATA

	1 cm	200 cm	300 cm
Nominal LED Flux:	2520 lm/m	5040 lm	7560 lm
Flux Tot:	2016 lm/m	4032 lm	6048 lm
Output:	105 lm/W	105 lm/W	105 lm/W
CCT:	3000 K	3000 K	3000 K
CRI:	>90	>90	>90
Power Tot:	23.0 W/m	46.0 W	69.0 W
Weight:	0.90 Kg/m	1.80 Kg	2.70 Kg
Profilo/Profile:	Alluminio/aluminum		Cover: Prismatico/prismatic

STAFFE DI FISSAGGIO A PARETE INCLUSE NEL CODICE / WALL MOUNTING BRACKETS INCLUDED IN THE CODE
CAVO ALIMENTAZIONE: 50 cm / ALIMENTATION CABLE: 50 cm

FINITURA STRUTTURA FINISHES	DIFFUSORE DIFFUSER	1 cm	200 cm	300 cm
		DRIVER NON INCLUSO NOT INCLUDED	DRIVER ON/OFF INCLUSO INCLUDED	DRIVER ON/OFF INCLUSO INCLUDED
GRIGIO VESUVIO ANTHRACITE	PRISMATIZZATO PRISMATIC	1114700041	1114700240	1114700340
ARGILLA CLAY		1114701041	1114701240	1114701340
ARGENTO OPACO MATT SILVER		1114702041	1114702240	1114702340
BIANCO INTONACO WHITE		1114703041	1114703240	1114703340
NERO CARAVAGGIO BLACK		1114704041	1114704240	1114704340
MOKA MOCHA		1114705041	1114705240	1114705340
ORO CALIFORNIA GOLD		1114709041	1114709240	1114709340
ARAMEN COPPER		1114710041	1114710240	1114710340
GRIGIO AVIO GREY AVIO		1114711041	1114711240	1114711340
ARGENTO COMETA SILVER COMET		1114712041	1114712240	1114712340
OTTONE VENEZIANO BRASS		1114713041	1114713240	1114713340
TITANIO TITANIUM		1114714041	1114714240	1114714340
BRONZO RIACI RIACI BRONZE		1114715041	1114715240	1114715340
VERDE COSTA GREEN COAST		1114716041	1114716240	1114716340
TERRA SENESE SENESE EARTH		1114717041	1114717240	1114717340
CROMO CHROME		1114708041	1114708240	

N.B./P.N.:
LUNGHEZZA MASSIMA VERSIONE CROMO = 2,00 m / MAXIMUM LENGTH CHROME VERSION = 2.00 m
TESTATE DI CHIUSURA NON INCLUSE / DEAD ENDS NOT INCLUDED

FINITURA STRUTTURA FINISHES	DIFFUSORE DIFFUSER	1 cm	200 cm	300 cm
		DRIVER NON INCLUSO NOT INCLUDED	DRIVER ON/OFF INCLUSO INCLUDED	DRIVER ON/OFF INCLUSO INCLUDED
GRIGIO VESUVIO ANTHRACITE	PRISMATIZZATO PRISMATIC	111H700041	111H700242	111H700342
ARGILLA CLAY		111H701041	111H701242	111H701342
ARGENTO OPACO MATT SILVER		111H702041	111H702242	111H702342
BIANCO INTONACO WHITE		111H703041	111H703242	111H703342
NERO CARAVAGGIO BLACK		111H704041	111H704242	111H704342
MOKA MOCHA		111H705041	111H705242	111H705342
ORO CALIFORNIA GOLD		111H709041	111H709242	111H709342
ARAMEN COPPER		111H710041	111H710242	111H710342
GRIGIO AVIO GREY AVIO		111H711041	111H711242	111H711342
ARGENTO COMETA SILVER COMET		111H712041	111H712242	111H712342
OTTONE VENEZIANO BRASS		111H713041	111H713242	111H713342
TITANIO TITANIUM		111H714041	111H714242	111H714342
BRONZO RIACI RIACI BRONZE		111H715041	111H715242	111H715342
VERDE COSTA GREEN COAST		111H716041	111H716242	111H716342
TERRA SENESE SENESE EARTH		111H717041	111H717242	111H717342
CROMO CHROME		111H708041	111H708242	

N.B./P.N.:
LUNGHEZZA MASSIMA VERSIONE CROMO = 2,00 m / MAXIMUM LENGTH CHROME VERSION = 2.00 m
TESTATE DI CHIUSURA NON INCLUSE / DEAD ENDS NOT INCLUDED

zero65 + zero65 p



zero65 + zero65 p

profilo

profiled

	1 cm	200 cm	300 cm
DIFFUSORE DIFFUSER OPALE/OPAL SATINATA/SATIN PRISMATIZZATO/PRISMATIC	CODICE CODE	CODICE CODE	CODICE CODE
	1100100001	1100100200	1100100300
	1100101001	1100101200	1100101300
	1100103001	1100103200	1100103300
	10 m		
DIFFUSORE DIFFUSER PRISMATIZZATO/PRISMATIC	CODICE CODE		
	1100103999		

zero65 + zero65 p

alluminio cover

aluminum cover



FINITURA STRUTTURA
FINISHES

- GRIGIO VESUVIO ANTHRACITE
- ARGILLA CLAY
- ARGENTO OPACO MATT SILVER
- BIANCO INTONACO/WHITE
- NERO CARAVAGGIO BLACK
- MOKA MOCHA
- ORO CALIFORNIA/GOLD
- ARAMEN COPPER
- GRIGIO AVIO/GREY AVIO
- ARGENTO COMETA/SILVER COMET
- OTTONE VENEZIANO BRASS
- TITANIO/TITANIUM
- BRONZO RIACI/RIACI BRONZE
- VERDE COSTA/GREEN COAST
- TERRA SENESE SENESE EARTH
- CROMO CHROME

	1 cm	200 cm	300 cm
CODICE CODE	CODICE CODE	CODICE CODE	CODICE CODE
1110200001	1110200200	1110200300	
1110201001	1110201200	1110201300	
1110202001	1110202200	1110202300	
1110203001	1110203200	1110203300	
1110204001	1110204200	1110204300	
1110205001	1110205200	1110205300	
1110209001	1110209200	1110209300	
1110210001	1110210200	1110210300	
1110211001	1110211200	1110211300	
1110212001	1110212200	1110212300	
1110213001	1110213200	1110213300	
1110214001	1110214200	1110214300	
1110215001	1110215200	1110215300	
1110216001	1110216200	1110216300	
1110217001	1110217200	1110217300	
1110208001	1110208200		

N.B./P.N.:
LUNGHEZZA MASSIMA VERSIONE CROMO = 2,00 m / MAXIMUM LENGTH CHROME VERSION = 2.00 m

LED compatibili / LED compatibility

HIGH QUALITY CRI>90 CRI>95	HIGH OUTPUT CRI>90 CRI>95	HIGH EFFICIENT CRI>90 CRI>95	HIGH INTENSITY CRI>90 CRI>95	LOW POWER CRI>90	ULTRA SLIM CRI>90 CRI>95 CRI>97	RGB	RGB WHITE	RGB TW	TUNABLE WHITE
9,6W 14,4W 19,2W	12,3W 14,4W 19,2W 20W 24W	12,3W 14,4W 19,2W 20W 24W	24W 24W (700 LED)	6W	9,6W 12W 14,4W	14W	14W	14,4W 23W	19,2W

FINITURA STRUTTURA
FINISHES

- GRIGIO VESUVIO ANTHRACITE
- ARGILLA CLAY
- ARGENTO OPACO MATT SILVER
- BIANCO INTONACO/WHITE
- NERO CARAVAGGIO BLACK
- MOKA MOCHA
- CROMO CHROME
- ORO CALIFORNIA/GOLD

1 cm	CODICE CODE
	1100500001
	1100501001
	1100502001
	1100503001
	1100504001
	1100505001
	1100508001
	1100509001

FINITURA STRUTTURA
FINISHES

- ARAMEN COPPER
- GRIGIO AVIO/GREY AVIO
- ARGENTO COMETA/SILVER COMET
- OTTONE VENEZIANO BRASS
- TITANIO/TITANIUM
- BRONZO RIACI/RIACI BRONZE
- VERDE COSTA/GREEN COAST
- TERRA SENESE SENESE EARTH

1 cm	CODICE CODE
	1100510001
	1100511001
	1100512001
	1100513001
	1100514001
	1100515001
	1100516001
	1100517001

TESTATE DI CHIUSURA / DEAD ENDS

FINITURA STRUTTURA FINISHES	CODICE CODE	FINITURA STRUTTURA FINISHES	CODICE CODE
GRIGIO VESUVIO ANTHRACITE	1110400000	ARAMEN COPPER	1110410000
ARGILLA CLAY	1110401000	GRIGIO AVIO GREY AVIO	1110411000
ARGENTO OPACO MATT SILVER	1110402000	ARGENTO COMETA SILVER COMET	1110412000
BIANCO INTONACO WHITE	1110403000	OTTONE VENEZIANO BRASS	1110413000
NERO CARAVAGGIO BLACK	1110404000	TITANIO/TITANIUM	1110414000
MOKA MOCHA	1110405000	BRONZO RIACI/RIACI BRONZE	1110415000
CROMO CHROME	1110408000	VERDE COSTA GREEN COAST	1110416000
ORO CALIFORNIA GOLD	1110409000	TERRA SENESE SENESE EARTH	1110417000

Nel codice sono comprese le viti per il fissaggio delle testate al profilo. Il codice contiene n° 1 testate di chiusura. / The code includes the screws for fixing the heads to the profile. The code contains 1 closing warheads

TESTATE DI CHIUSURA CON LOGO / DEAD ENDS WITH LOGO

FINITURA STRUTTURA FINISHES	CODICE CODE	FINITURA STRUTTURA FINISHES	CODICE CODE
GRIGIO VESUVIO ANTHRACITE	1110600000	GRIGIO AVIO GREY AVIO	1110611000
ARGILLA CLAY	1110601000	ARGENTO COMETA SILVER COMET	1110612000
BIANCO INTONACO WHITE	1110603000	OTTONE VENEZIANO BRASS	1110613000
NERO CARAVAGGIO BLACK	1110604000	TITANIO/TITANIUM	1110614000
MOKA MOCHA	1110605000	BRONZO RIACI/RIACI BRONZE	1110615000
CROMO CHROME	1110608000	VERDE COSTA GREEN COAST	1110616000
ORO CALIFORNIA GOLD	1110609000	TERRA SENESE SENESE EARTH	1110617000
ARAMEN COPPER	1110610000		

Nel codice sono comprese le viti per il fissaggio delle testate al profilo. Il codice contiene n° 1 testate di chiusura. / The code includes the screws for fixing the heads to the profile. The code contains 1 closing warheads

STAFFA DI FISSAGGIO A CARTONGESSO / MOUNTING CLIP FOR PLASTERBOARD

Accessorio che consente l'incasso del profilo.
Accessory that allows the collection of the profile

Nel codice sono comprese le viti per il fissaggio del
profilo alla staffa.
The code includes screws for fixing the profile to the bracket

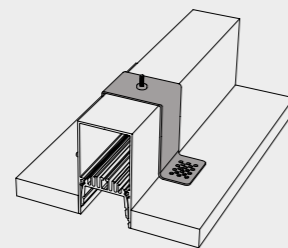

FINITURA
FINISHES

CODICE
CODE

ALLUMINIO NATURALE/ALUMINUM 1110500002

KIT DI SOSPENSIONE / SUSPENSION KIT

ARTICOLI INCLUSI NEL CODICE
ARTICLES INCLUDED IN THE CODE

Cavo in acciaio 2,00 m con puntalino
2.00 m steel cable with tip
Boccola cromata con regolazione millimetrica
Chrome bush with millimeter adjustment

Cavo in acciaio 3,00m con puntalino
3.00m steel cable with tip

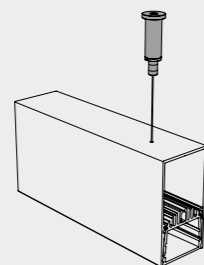

FINITURA
FINISHES

CODICE
CODE

CROMO CHROME 11100508200

CROMO CHROME 11100508F30

GIUNTI / JOINTS

	FINITURA FINISHES	CODICE CODE
GIUNTO LINEA CONTINUA / STRAIGHT JOINT Accessorio per giunzioni meccaniche lineari Accessory for linear mechanical joints	ALLUMINIO NATURALE/ALUMINUM	1110506001
GIUNTO 90° ORIZZONTALE / HORIZONTAL JOINT 90° Accessorio per giunzioni meccaniche con angolo 90° Accessory for linear mechanical joints with 90° angle	ALLUMINIO NATURALE/ALUMINUM	1110506002
GIUNTO ANGOLARE A T / ANGULAR T-JOINT Accessorio per giunzioni meccaniche a T Accessory for mechanical T-junctions	ALLUMINIO NATURALE/ALUMINUM	1110506003
GIUNTO ANGOLARE A X / ANGULAR X-JOINT Accessorio per giunzioni meccaniche a X Accessory for mechanical X-junctions	ALLUMINIO NATURALE/ALUMINUM	1110506004

Nel codice sono compresi i grani per il fissaggio del giunto / The code includes the grains for fixing the joint.

LAVORAZIONI / PROCESSING

DATI TECNICI TECHNICAL DATA	CODICE CODE
TAGLIO 90° ORIZZONTALE (PER ANGOLI FORMATI DA DUE PROFILI) HORIZONTAL 90° CUT (FOR CORNERS MADE OF TWO PROFILES)	190X
TAGLIO ANGOLARE CUSTOM (PER ANGOLI FORMATI DA DUE PROFILI) CUSTOM CORNER CUT (FOR CORNERS MADE OF TWO PROFILES)	190N
ASOLA STANDARD 2X1CM / STANDARD SLOT 2X1CM	100A
ASOLA CUSTOMIZZATA / CUSTOM SLOT	100N
FORO / HOLE	100F
CABLAGGIO - COLLAUDO - CE AL CENTIMETRO INSTALLATION AND TESTING LED MODULE AT CENTIMETER	1111
CONNETTORE MASCHIO/FEMMINA MALE/FEMALE CONNECTOR	98CFM
CONNETTORE MASCHIO/FEMMINA MONTATO NEL PRODOTTO MALE/FEMALE CONNECTOR FITTED IN THE PRODUCT	98MFM
MONTAGGIO CABLAGGIO COLLAUDO CE DRIVER 60W MOUNTING WIRING TESTING CE MARKING DRIVER 60W	1050A
MONTAGGIO CABLAGGIO COLLAUDO CE DRIVER 96W MOUNTING WIRING TESTING CE MARKING DRIVER 96W	1096A
MONTAGGIO CABLAGGIO COLLAUDO CE DRIVER DIM 70W MOUNTING WIRING TESTING CE MARKING DIM DRIVER 70W	1070D
MONTAGGIO CABLAGGIO COLLAUDO CE DRIVER DIM 100W MOUNTING WIRING TESTING CE MARKING DRIVER DIM 100W	1101D
CAVO DI ALIMENTAZIONE 2X0,75 TONDO TRASPARENTE 1CM POWER CABLE 2X0,75 ROUND TRANSPARENT 1CM	98CTT001

zero65 spot advanced

zero65 spot advanced

designer

luigi cerbone

“moduli customizzabili”

ZER065 SPOT ADVANCE è un prodotto composto da moduli customizzabili che consentono di avere sul medesimo sistema lineare diverse sorgenti luminose. A seconda delle necessità si può richiedere l'installazione di moduli SPOT abbinati a moduli LED. Lo ZER065 SPOT ADVANCE è un prodotto multi installazione: sospensione e soffitto. È particolarmente adatto per illuminare spazi espositivi.

ZER065 SPOT ADVANCE is a product composed of customizable modules that allow you to have different light sources on the same linear system. Depending on your needs, you can request the installation of SPOT modules combined with LED modules. The ZER065 SPOT ADVANCE is a multi-installation product: suspension and ceiling. It is particularly suitable for illuminating exhibition spaces.



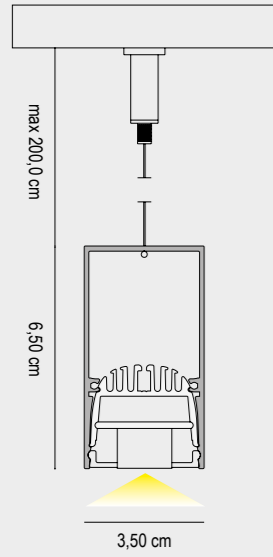

DATI TECNICI
TECHNICAL DATA

	120 cm (15+90+15)cm	150 cm (15+120+15)cm	180 cm (15+150+15)cm
Nominal LED Flux:	1980 lm	2640 lm	3300 lm
Nominal SPOT Flux:	1524 lm	1524 lm	1524 lm
Flux Tot:	2803 lm	3331 lm	3860 lm
Output:	105 lm/W + 121 lm/W	105 lm/W + 121 lm/W	105 lm/W + 121 lm/W
CCT:	3000 K	3000 K	3000 K
CRI:	>95	>95	>95
LED Power Tot:	18.0W	24.0W	30.0W
SPOT Power Tot:	18.0W (3W x 6)	18.0W (3W x 6)	18.0W (3W x 6)
Weight:	2.04 Kg	2.55 Kg	3.06 Kg

Profilo/Profile: Alluminio/aluminum

Cover: Opale/opal

ARTICOLI INCLUSI NEL CODICE / ITEMS INCLUDED IN THE CODE:
DRIVER ON/OFF
COPPIA DI TESTATE DI CHIUSURA / PAIR OF CLOSING HEADS
KIT DI SOSPENSIONE / SUSPENSION KIT

120 cm (15+90+15)cm 150 cm (15+120+15)cm 180 cm (15+150+15)cm

FINITURA STRUTTURA
FINISHES

- GRIGIO VESUVIO ANTHRACITE
- ARGILLA CLAY
- BIANCO INTONACO/WHITE
- NERO CARAVAGGIO BLACK
- MOKA MOCHA
- CROMO/CHROME
- ORO CALIFORNIA GOLD
- ARAMEN COPPER
- ARGENTO COMETA/SILVER COMET
- OTTONE VENEZIANO VENETIAN BRASS
- TITANIO/TITANIUM
- BRONZO RIACI/RIACI BRONZE
- VERDE COSTA/GREEN COAST
- TERRA SENESE SENESE EARTH
- NERO-CROMO BLACK-CHROME

DIFFUSORE
DIFFUSER

OPALE/OPAL

	120 cm (15+90+15)cm	150 cm (15+120+15)cm	180 cm (15+150+15)cm
CODICE CODE			
	1118400120	1118400150	1118400180
	1118401120	1118401150	1118401180
	1118403120	1118403150	1118403180
	1118404120	1118404150	1118404180
	1118405120	1118405150	1118405180
	1118408120	1118408150	1118408180
	1118409120	1118409150	1118409180
	1118410120	1118410150	1118410180
	1118412120	1118412150	1118412180
	1118413120	1118413150	1118413180
	1118414120	1118414150	1118414180
	1118415120	1118415150	1118415180
	1118416120	1118416150	1118416180
	1118417120	1118417150	1118417180
	1118448120	1118448150	1118448180

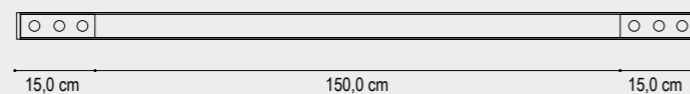
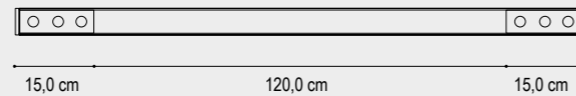
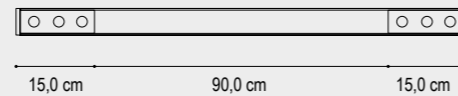

“eleganza e tagli di luce”

ZERO66 costruito in estruso di alluminio si avvale della tecnologia degli schermi in policarbonato per diffondere la luce per mezzo di LED al top, per qualità, resa cromatica, lumen emessi, ed accurata selezione della temperatura colore, scelta in base al progetto scenografico che vogliamo ottenere. ZERO66 è la versione della famiglia ZERO per l'installazione a cartongesso. È caratterizzato dai due bordi laterali in alluminio che aiutano nell'installazione e regalano eleganza al taglio di luce.

ZERO66 made of extruded aluminum uses the technology of polycarbonate screens to diffuse the light by means of top LEDs, for quality, color rendering, lumens emitted, and careful selection of the color temperature, chosen on the basis of the scenographic project which we want to get. ZERO66 is the version of the ZERO family for plasterboard installation. It is characterized by two aluminum side edges that help in the installation and give elegance to the cut of light.

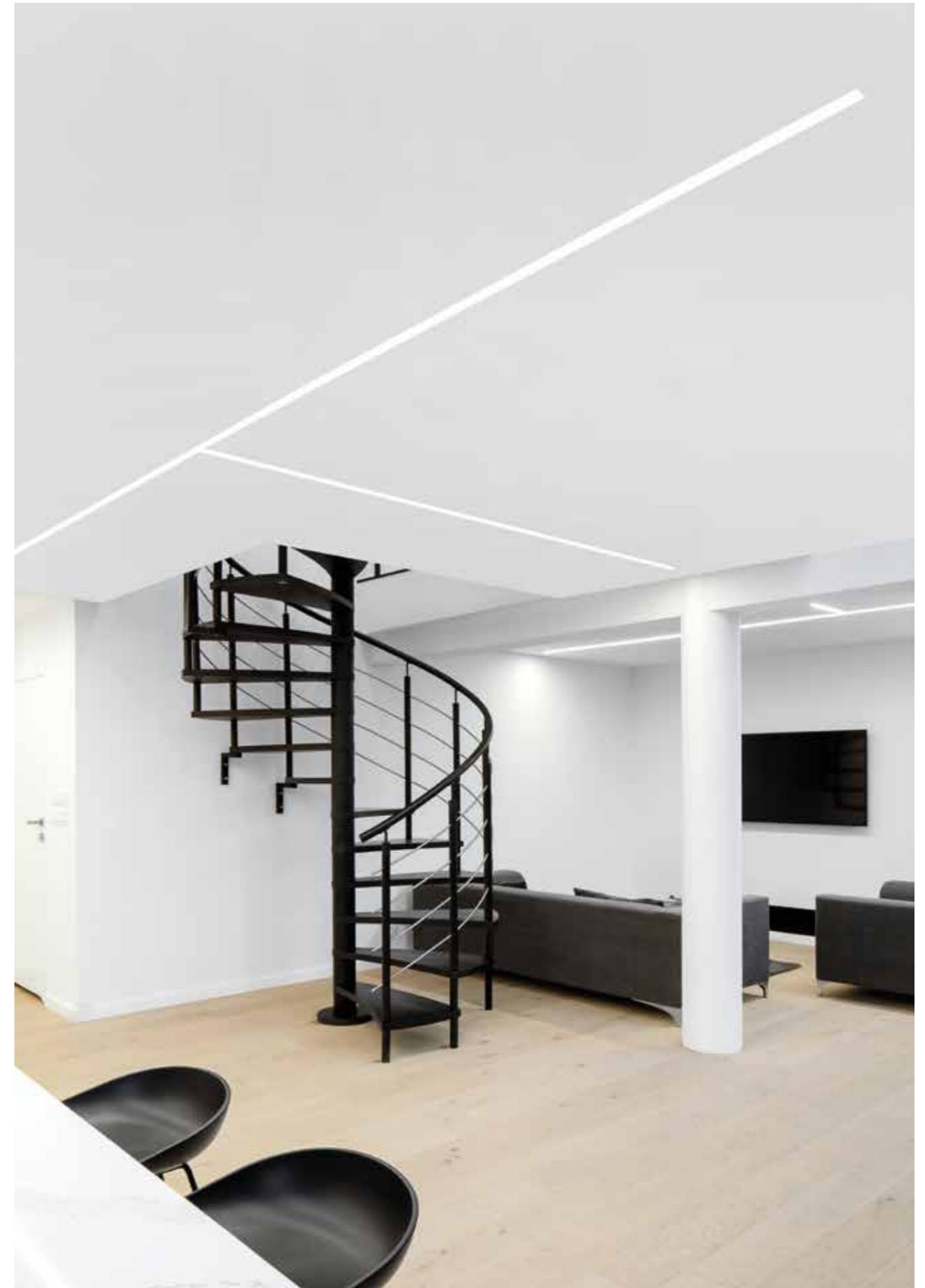

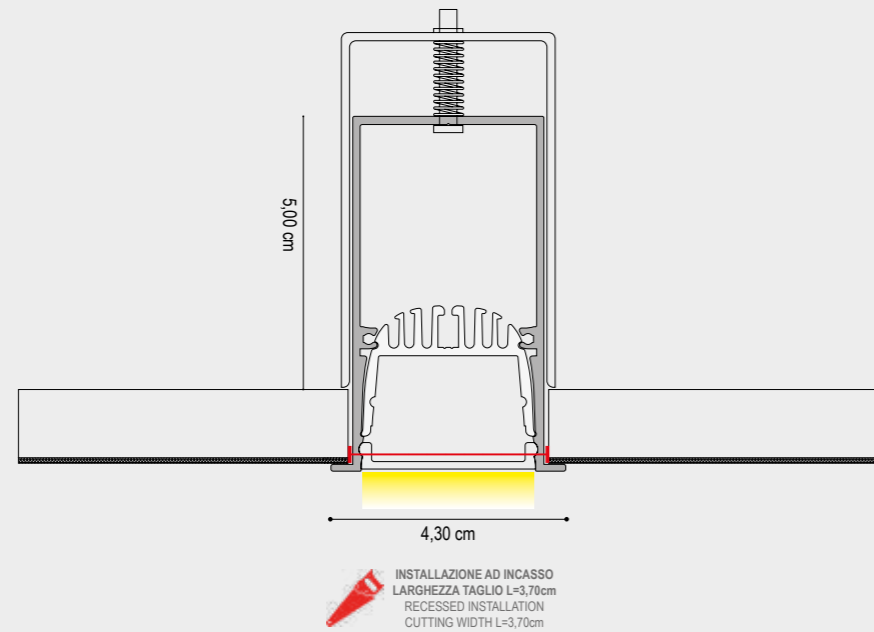

ATTENZIONE! GLI ACCESSORI PER L'INSTALLAZIONE A INCASSO SONO STATI DIMENSIONATI PER UN PANNELLO STANDARD IN CARTONGESSO DI SPESSORE 12,5 mm
WARNING! THE BUILT-IN INSTALLATION ACCESSORIES HAVE BEEN DIMENSIONED FOR A STANDARD PLASTERBOARD PANEL OF 12.5 mm THICKNESS

DATI TECNICI
TECHNICAL DATA

	1 cm
Nominal LED Flux:	2520 lm/m
Flux Tot:	2016 lm/m
Output:	110 lm/W
CCT:	3000 K
CRI:	>90
Power Tot:	23.0 W/m
Weight:	0.90 Kg/m

DRIVER NON INCLUSO/NOT INCLUDED
CAVO ALIMENTAZIONE: 50 cm
ALIMENTATION CABLE: 50 cm

Lmax = 300 cm

FINITURA STRUTTURA
FINISHES

- ARGILLA CLAY
- BIANCO INTONACO/WHITE
- NERO CARAVAGGIO/BLACK
- TERRA SENESE SENESE EARTH

DIFFUSORE
DIFFUSER

- OPALE/OPAL

	2700K 1 cm	3000K 1 cm	4000K 1 cm
CODICE CODE	112H600001	112H700001	112H800001
	112H601001	112H701001	112H801001
	112H603001	112H703001	112H803001
	112H617001	112H717001	112H817001

N.B./P.N.:

LUNGHEZZA MASSIMA VERSIONE CROMO = 2,00 m / MAXIMUM LENGTH CHROME VERSION = 2.00 m
TESTATE DI CHIUSURA NON INCLUSE / DEAD ENDS NOT INCLUDED

DATI TECNICI
TECHNICAL DATA

	1 cm	200 cm	300 cm
Nominal LED Flux:	4440 lm/m	8880 lm	13320 lm
Flux Tot:	3552 lm/m	7104 lm	10656 lm
Output:	148 lm/W	148 lm/W	148 lm/W
CCT:	3000 K	3000 K	3000 K
CRI:	>90	>90	>90
Power Tot:	30.0 W/m	60.0 W	90.0 W
Weight:	0.90 Kg/m	1.80 Kg	2.70 Kg

Profilo/Profile: Alluminio/aluminum
Cover: Opale/opal

Lmax = 300 cm

DRIVER INCLUSO/NOT INCLUDED

CAVO ALIMENTAZIONE: 50 cm
ALIMENTATION CABLE: 50 cm

A. COMPOSIZIONE ANGOLARE A "L"
A. L-ANGLE COMPOSITION

B. COMPOSIZIONE ANGOLARE A "C"
B. C-ANGLE COMPOSITION

C. COMPOSIZIONE POLIGONALE
(QUADRATO/RETTANGOLO)
C. POLYGONAL COMPOSITION
(SQUARE / RECTANGLE)

D. COMPOSIZIONE POLIGONALE
(PENTAGONO/ESAGONO)
D. POLYGONAL COMPOSITION
(PENTAGON / HEX)

PER LE COMPOSIZIONI POLIGONALI RIVOLGERSI AL NOSTRO REPARTO TECNICO.
FOR POLYGONAL COMPOSITIONS, PLEASE CONTACT OUR TECHNICAL DEPARTMENT.

FINITURA STRUTTURA
FINISHES

- ARGILLA CLAY
- BIANCO INTONACO/WHITE
- NERO CARAVAGGIO/BLACK
- TERRA SENESE SENESE EARTH

DIFFUSORE
DIFFUSER

- OPALE/OPAL

	1 cm	200 cm	300 cm
CODICE CODE	1128101001	1128101200	1128101300
	1128103001	1128103200	1128103300
	1128104001	1128104200	1128104300
	1128117001	1128117200	1128117300

N.B./P.N.:

LUNGHEZZA MASSIMA VERSIONE CROMO = 2,00 m / MAXIMUM LENGTH CHROME VERSION = 2.00 m
TESTATE DI CHIUSURA NON INCLUSE / DEAD ENDS NOT INCLUDED



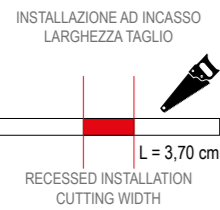
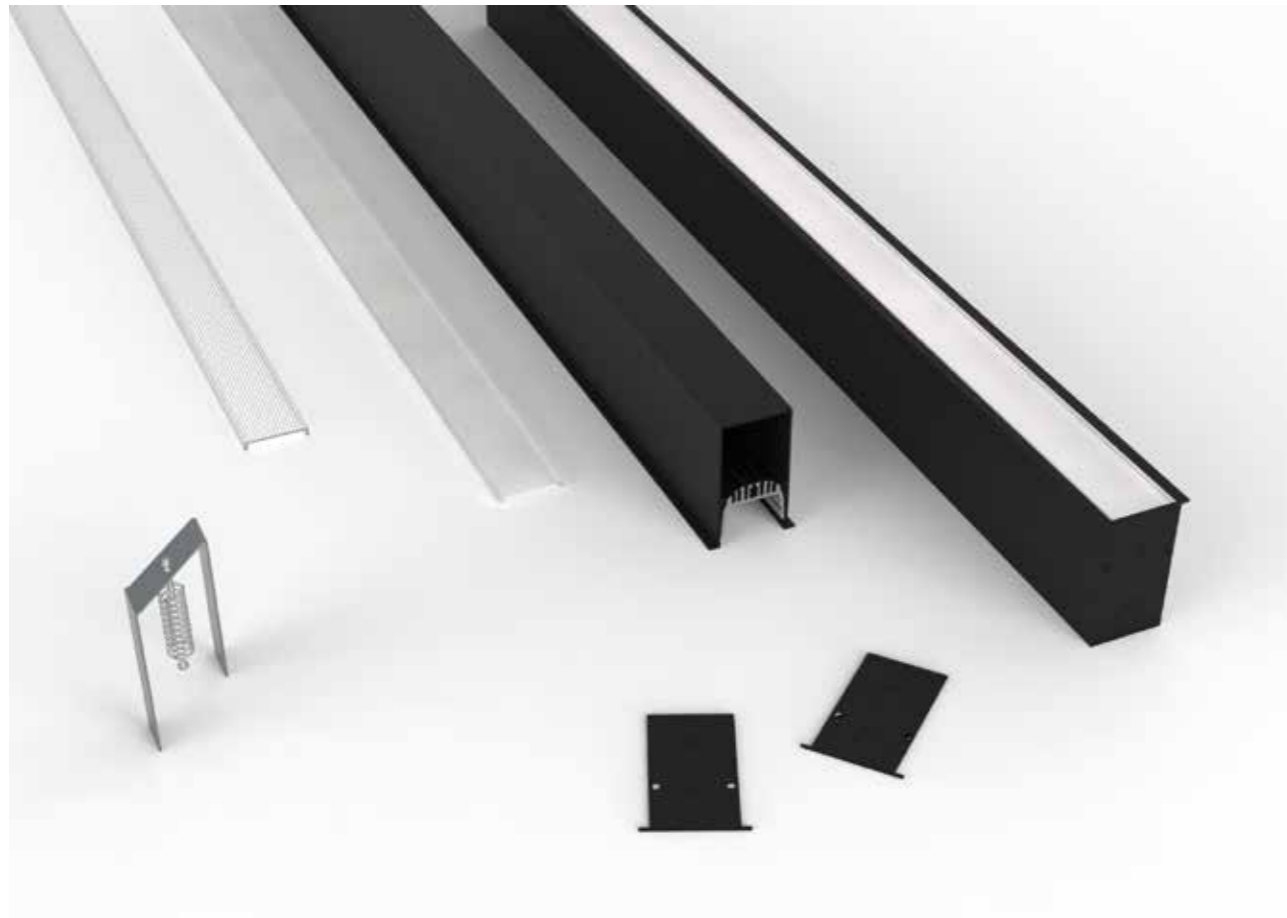

Profilo in alluminio
Profile in aluminum

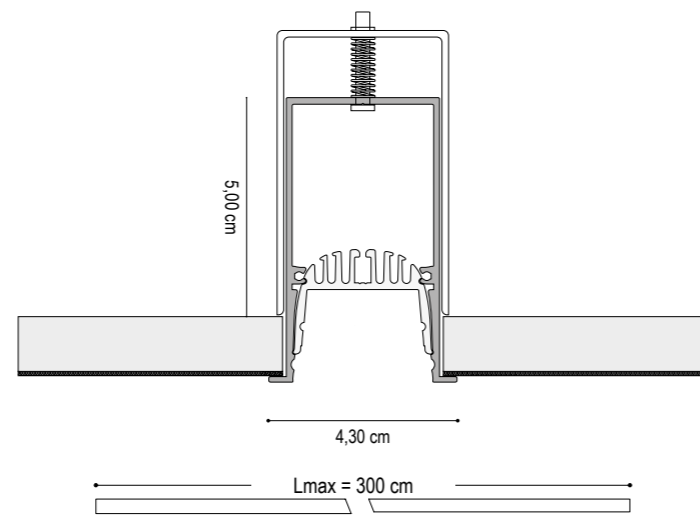

LED compatibili / LED compatibility

HIGH QUALITY CRI>90 CRI>95	HIGH OUTPUT CRI>90 CRI>95	HIGH EFFICIENT CRI>90 CRI>95	HIGH INTENSITY CRI>90 CRI>95	LOW POWER CRI>90	ULTRA SLIM CRI>90 CRI>95 CRI>97	RGB	RGB WHITE	RGB TW	TUNABLE WHITE
9,6W 14,4W 19,2W	12,3W 14,4W 19,2W 20W 24W	12,3W 14,4W 19,2W 20W 24W	24W 24W (700 LED)	6W	9,6W 12W 14,4W	14W	14W	14,4W 23W	19,2W

FINITURA STRUTTURA
FINISHES

- ARGILLA CLAY
- BIANCO INTONACO/WHITE
- NERO CARAVAGGIO/BLACK
- TERRA SENESE SENESE EARTH

1 cm

200 cm

300 cm

CODICE
CODE

CODICE
CODE

CODICE
CODE

- 1120301001
- 1120303001
- 1120304001
- 1120317001

- 1120301200
- 1120303200
- 1120304200
- 1120317200

- 1120301300
- 1120303300
- 1120304300
- 1120317300

N.B./P.N.:

LUNGHEZZA MASSIMA VERSIONE CROMO = 2,00 m / MAXIMUM LENGTH CHROME VERSION = 2.00 m

DIFFUSORE

1 cm

200 cm

300 cm

DIFFUSORE
DIFFUSER

- OPALE/OPAL
- SATINATA/SATIN
- PRISMATIZZATO/PRISMATIC

CODICE
CODE

CODICE
CODE

CODICE
CODE

- 1100100001
- 1100101001
- 1100103001

- 1100100200
- 1100101200
- 1100103200

- 1100100300
- 1100101300
- 1100103300



COVER ALLUMINIO / ALUMINUM COVER

1 cm

FINITURA STRUTTURA
FINISHES

- ARGILLA CLAY
- BIANCO INTONACO/WHITE
- NERO CARAVAGGIO/BLACK
- TERRA SENESE SENESE EARTH

CODICE
CODE

- 1100501001
- 1100503001
- 1100504001
- 1100517001



TESTATE DI CHIUSURA / DEAD ENDS

	FINITURA STRUTTURA FINISHES	CODICE CODE	PREZZO PRICE	FINITURA STRUTTURA FINISHES	CODICE CODE
	ARGILLA CLAY	1120401000	€ 9,40	NERO CARAVAGGIO BLACK	1120404000
	BIANCO INTONACO/WHITE	1120403000	€ 9,40	TERRA SENESE SENESE EARTH	1120417000

Nel codice sono comprese le viti per il fissaggio delle testate al profilo. Il codice contiene n° 1 testate di chiusura. / The code includes the screws for fixing the heads to the profile. The code contains 1 closing warheads

GIUNTI / JOINTS

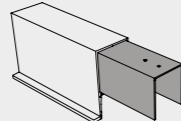
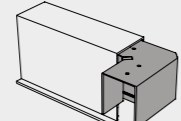
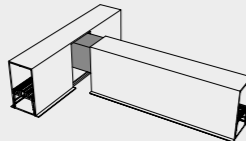
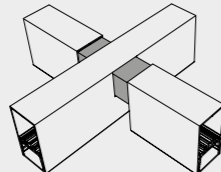
		FINITURA FINISHES	CODICE CODE
GIUNTO LINEA CONTINUA / STRAIGHT JOINT Accessorio per giunzioni meccaniche lineari Accessory for linear mechanical joints		ALLUMINIO NATURALE/ALUMINUM	1110506001
GIUNTO 90° ORIZZONTALE / HORIZONTAL JOINT 90° Accessorio per giunzioni meccaniche con angolo 90° Accessory for linear mechanical joints with 90° angle		ALLUMINIO NATURALE/ALUMINUM	1110506002
GIUNTO ANGOLARE A T / ANGULAR T-JOINT Accessorio per giunzioni meccaniche a T Accessory for mechanical T-junctions		ALLUMINIO NATURALE/ALUMINUM	1120506003
GIUNTO ANGOLARE A X / ANGULAR X-JOINT Accessorio per giunzioni meccaniche a X Accessory for mechanical X-junctions		ALLUMINIO NATURALE/ALUMINUM	1120506004













Nel codice sono compresi i grani per il fissaggio del giunto / The code includes the grains for fixing the joint.

STAFFA DI FISSAGGIO A CARTONGESSO / MOUNTING CLIP FOR PLASTERBOARD

	FINITURA FINISHES	CODICE CODE
Accessorio che consente l'incasso del profilo. Accessory that allows the collection of the profile Nel codice sono comprese le viti per il fissaggio del profilo alla staffa. The code includes screws for fixing the profile to the bracket	ALLUMINIO NATURALE/ALUMINUM	1120501



LAVORAZIONI / PROCESSING

DATI TECNICI TECHNICAL DATA	CODICE CODE
 TAGLIO 90° ORIZZONTALE (PER ANGOLI FORMATI DA DUE PROFILI) HORIZONTAL 90 ° CUT (FOR CORNERS MADE OF TWO PROFILES)	190X
 TAGLIO ANGOLARE CUSTOM (PER ANGOLI FORMATI DA DUE PROFILI) CUSTOM CORNER CUT (FOR CORNERS MADE OF TWO PROFILES)	190N
 ASOLA / SLOT	100A
 ASOLA CUSTUM / SLOT CUSTUM	100N
 FORO / HOLE	100F
 CABLAGGIO - COLLAUDO - CE AL CENTIMETRO INSTALLATION AND TESTING LED MODULE AT CENTIMETER	1111
 CONNETTORE MASCHIO/FEMMINA MALE/FEMALE CONNECTOR	98CFM
 CONNETTORE MASCHIO/FEMMINA MONTATO NEL PRODOTTO MALE/FEMALE CONNECTOR FITTED IN THE PRODUCT	98MFM
 MONTAGGIO CABLAGGIO COLLAUDO CE DRIVER 60W MOUNTING WIRING TESTING CE MARKING DRIVER 60W	1050A
 MONTAGGIO CABLAGGIO COLLAUDO CE DRIVER 96W MOUNTING WIRING TESTING CE MARKING DRIVER 96W	1096A
 MONTAGGIO CABLAGGIO COLLAUDO CE DRIVER DIM 70W MOUNTING WIRING TESTING CE MARKING DIM DRIVER 70W	1070D
 MONTAGGIO CABLAGGIO COLLAUDO CE DRIVER DIM 100W MOUNTING WIRING TESTING CE MARKING DRIVER DIM 100W	1101D
 CAVO DI ALIMENTAZIONE 2X0,75 TONDO TRASPARENTE 1CM POWER CABLE 2X0,75 ROUND TRANSPARENT 1CM	98CTT001

“il benessere della luce naturale”

Q20 La luce naturale incentiva la comunicazione il benessere e regola i ritmi biologici della vita. È la nostra risposta nella ricerca continua di creare una luce che trasmetta sensazioni stimolanti, aiuti nell'orientamento ed esprima qualità, soprattutto quando le architetture raggiungono altissimi livelli qualitativi e prestazionali. Q20 contribuisce a tutto questo grazie alle sue lenti e alla tecnologia led appositamente progettata per garantire la possibilità di studiare e personalizzare ogni tipo di progetto commerciale, museale.

Q20 Natural light stimulates communication, well-being and regulates the biological rhythms of life. It is our response in the continuous search to create a light that transmits stimulating sensations, helps in orientation and expresses quality, especially when the architectures reach the highest quality and performance levels. Q20 contributes to all this thanks to its lenses and LED technology specially designed to guarantee the possibility of studying and customizing any type of commercial, museum project.

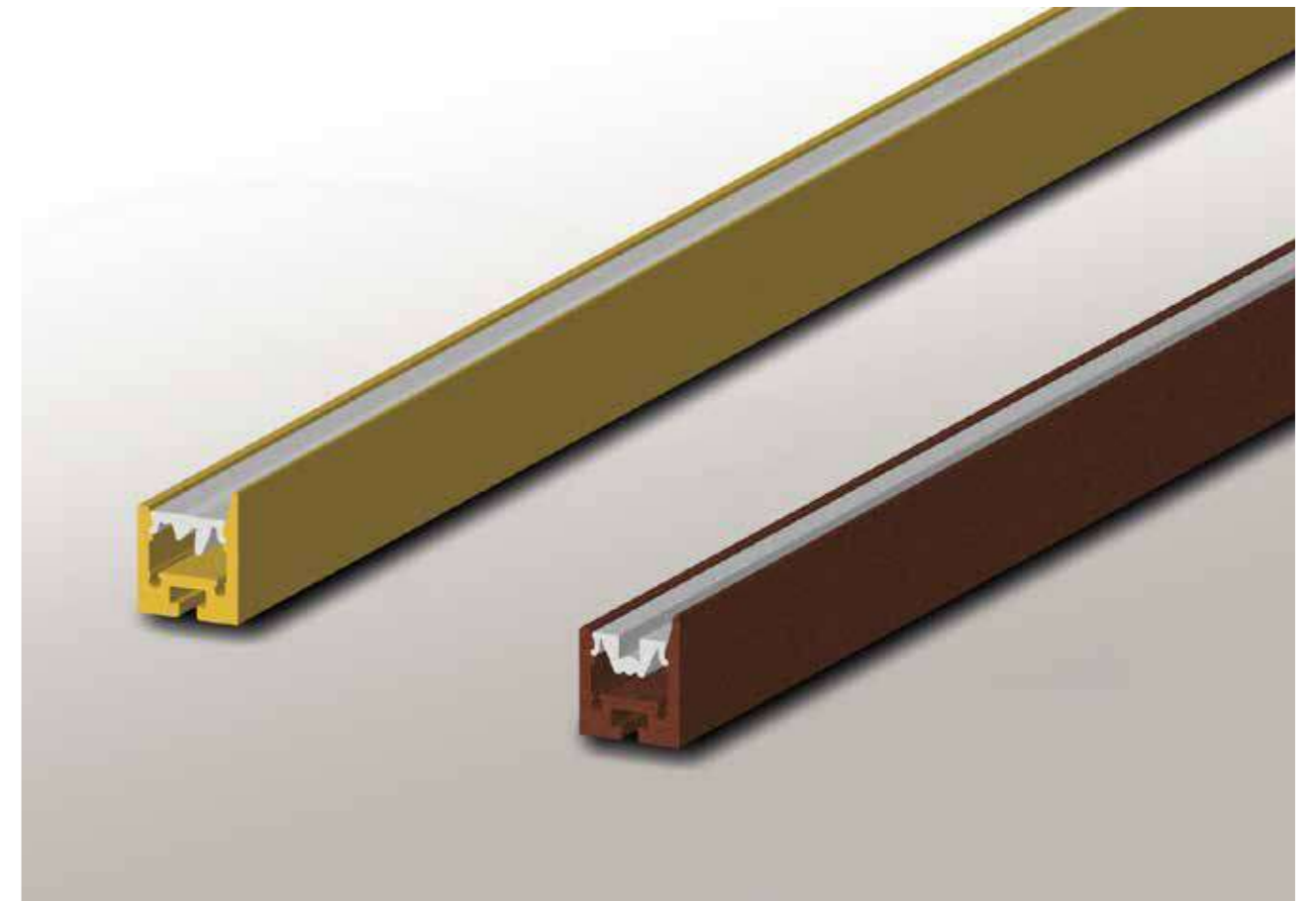

VERSIONE SPOT (15°)
SPOT VERSION (15°)

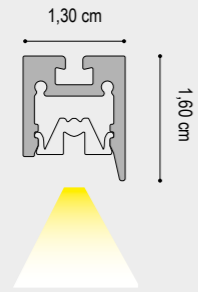

VERSIONE WALL WASHER (45°)
WALL WASHER VERSION (45°)

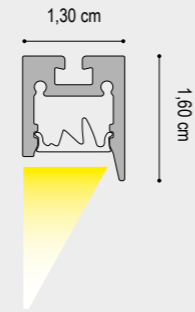

LE CONFIGURAZIONI RIPORTATE SONO COMPATIBILI PER LA VERSIONE SPOT E PER LA VERSIONE WALL WASHER.
THE CONFIGURATIONS SHOWN ARE COMPATIBLE FOR THE SPOT VERSION AND FOR THE WALL WASHER VERSION.

INSTALLAZIONE A SOSPENSIONE
SUSPENSION

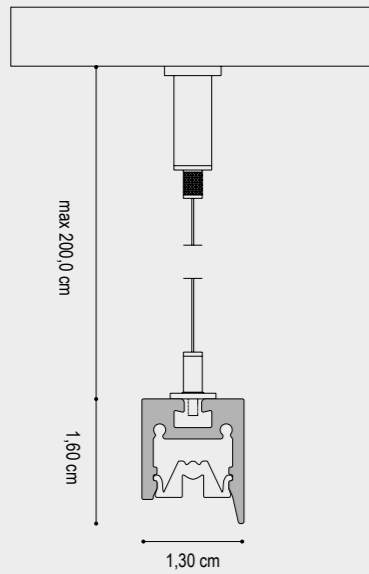

INSTALLAZIONE CON CLIP IN POLICARBONATO SU SUPERFICIE ORIZZONTALE
INSTALLATION WITH POLYCARBONATE CLIP ON HORIZONTAL SURFACE

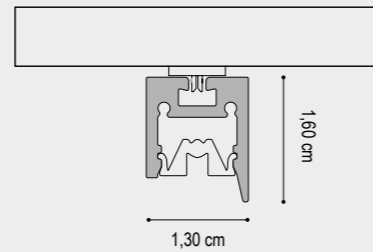

INSTALLAZIONE CON STAFFE MAGNETICHE SU SUPERFICIE METALLICA ORIZZONTALE
INSTALLATION WITH MAGNET ON HORIZONTAL METAL SURFACE

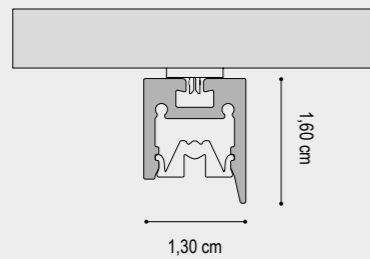

SI RACCOMANDA L'UTILIZZO DI N° 1 STAFFA MAGNETICA OGNI 25,00 cm DI PROFILO. TALE QUANTITÀ PUÒ VARIARE A SECONDA DELLA SUPERFICIE METALLICA DI INSTALLAZIONE.

WE RECOMMEND THE USE OF N° 1 MAGNETIC BRACKET EVERY 25.00 cm OF PROFILE. THIS QUANTITY MAY VARY DEPENDING ON THE METAL INSTALLATION SURFACE.

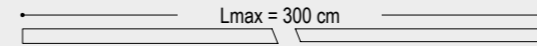
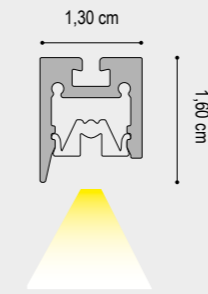

DATI TECNICI
TECHNICAL DATA

1 cm	
Nominal LED Flux:	1900 lm/m
Flux Tot:	1700 lm/m
Output:	158 lm/W
CCT:	3000 K
CRI:	>90
Power Tot:	12.0W/m
Weight:	0.30 Kg/m
Profilo/Profile:	Alluminio/aluminum
Lente/Lens:	15°

DRIVER NON INCLUSO / NOT INCLUDED

CAVO ALIMENTAZIONE: 50 cm
ALIMENTATION CABLE: 50 cm

FINITURA STRUTTURA
FINISHES

- GRIGIO VESUVIO ANTHRACITE
- ARGILLA CLAY
- ARGENTO OPACO MATT SILVER
- BIANCO INTONACO/WHITE
- NERO CARAVAGGIO BLACK
- MOKA MOCHA
- CROMO/CHROME
- ORO CALIFORNIA/GOLD
- ARAMEN COPPER
- ARGENTO COMETA/SILVER COMET
- OTTONE VENEZIANO/VENETIAN BRASS
- TITANIO/TITANIUM
- BRONZO RIACI/RIACI BRONZE
- VERDE COSTA/GREEN COAST
- TERRA SENESE SENESE EARTH

DIFFUSORE
DIFFUSER

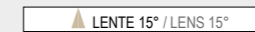

1 cm - 30W/m

CODICE
CODE

- 195500S001
- 195501S001
- 195502S001
- 195503S001
- 195504S001
- 195505S001
- 195508S001
- 195509S001
- 195510S001
- 195512S001
- 195513S001
- 195514S001
- 195515S001
- 195516S001
- 195517S001

N.B./P.N.: LUNGHEZZA MASSIMA VERSIONE CROMO = 2,00 m / MAXIMUM LENGTH CHROME VERSION = 2.00 m
TESTATE DI CHIUSURA NON INCLUSE / DEAD ENDS NOT INCLUDED

DIAGRAMMA FOTOMETRICO
LENTE SPOT - 15°

PHOTOMETRIC DIAGRAM
SPOT LENS - 15°

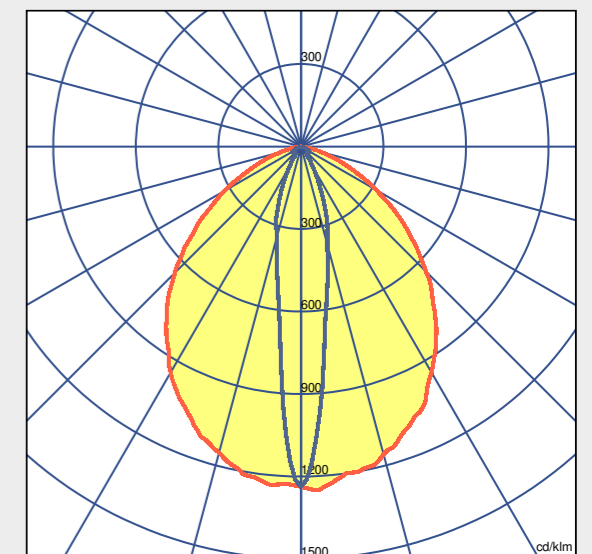

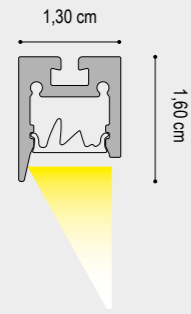

DATI TECNICI
TECHNICAL DATA

1 cm	
Nominal LED Flux:	1900 lm/m
Flux Tot:	1700 lm/m
Output:	158 lm/W
CCT:	3000 K
CRI:	>90
Power Tot:	12.0W/m
Weight:	0.30 Kg/m
Profilo/Profile:	Alluminio/aluminum
Lente/Lens:	45°

DRIVER NON INCLUSO / NOT INCLUDED

CAVO ALIMENTAZIONE: 50 cm
ALIMENTATION CABLE: 50 cm

Lmax = 300 cm

FINITURA STRUTTURA
FINISHES

- GRIGIO VESUVIO ANTHRACITE
- ARGILLA CLAY
- ARGENTO OPACO/MATT SILVER
- BIANCO INTONACO/WHITE
- NERO CARAVAGGIO BLACK
- MOKA MOCHA
- CROMO/CHROME
- ORO CALIFORNIA/GOLD
- ARAMEN COPPER
- ARGENTO COMETA/SILVER COMET
- OTTONE VENEZIANO/NETIAN BRASS
- TITANIO/TITANIUM
- BRONZO RIACI/RIACI BRONZE
- VERDE COSTA/GREEN COAST
- TERRA SENESE SENESE EARTH

DIFFUSORE
DIFFUSER

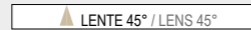

1 cm - 30W/m

CODICE
CODE

- 195500W001
- 195501W001
- 195502W001
- 195503W001
- 195504W001
- 195505W001
- 195508W001
- 195509W001
- 195510W001
- 195512W001
- 195513W001
- 195514W001
- 195515W001
- 195516W001
- 195517W001

N.B./P.N.: LUNGHEZZA MASSIMA VERSIONE CROMO = 2,00 m / MAXIMUM LENGTH CHROME VERSION = 2.00 m
TESTATE DI CHIUSURA NON INCLUSE / DEAD ENDS NOT INCLUDED

DIAGRAMMA FOTOMETRICO
LENTE WALL WASHER - 45°

PHOTOMETRIC DIAGRAM
WALL WASHER LENS - 45°

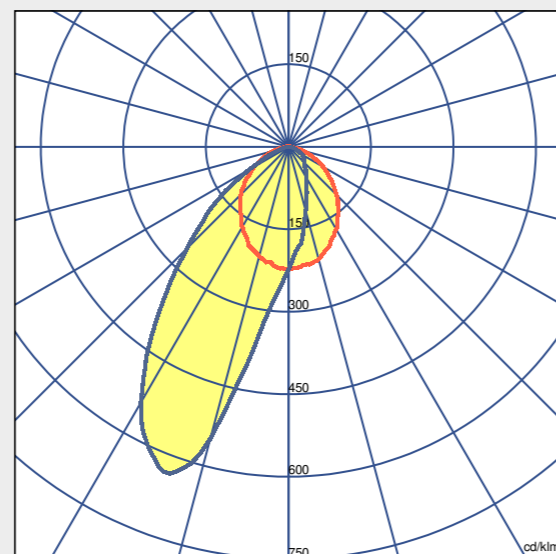

TESTATE DI CHIUSURA / DEAD ENDS



FINITURA STRUTTURA
FINISHES

- GRIGIO VESUVIO ANTHRACITE
- ARGILLA CLAY
- ARGENTO OPACO/MATT SILVER
- BIANCO INTONACO/WHITE
- NERO CARAVAGGIO BLACK
- MOKA MOCHA
- CROMO/CHROME
- ORO CALIFORNIA/GOLD

CODICE
CODE

- 190400
- 190401
- 190402
- 190403
- 190404
- 190405
- 190408
- 190409

FINITURA STRUTTURA
FINISHES

- ARAMEN COPPER
- GRIGIO AVIO GREY AVIO
- ARGENTO COMETA/SILVER COMET
- OTTONE VENEZIANO BRASS
- TITANIO/TITANIUM
- BRONZO RIACI/RIACI BRONZE
- VERDE COSTA/GREEN COAST
- TERRA SENESE SENESE EARTH

CODICE
CODE

- 190410
- 190411
- 190412
- 190413
- 190414
- 190415
- 190416
- 190417

Nel codice sono comprese le viti per il fissaggio delle testate al profilo. Il codice contiene n° 1 testate di chiusura. / The code includes the screws for fixing the heads to the profile. The code contains 1 closing warheads

STAFFA DI FISSAGGIO / MOUNTING CLIP



FINITURA
FINISHES

- SUPERFICI PIANE 2mm
EVEN SURFACE 2mm
- SUPERFICI IRREGOLARI 3,5mm
UNEVEN SURFACE 3,5mm

CODICE
CODE

- 1020500003
- 1020500004

Accessorio per fissaggio a plafone/superficie. Quantità raccomandata: 1 pz ogni 50 cm di profilo
Ceiling/surface mounting accessory. Recommended quantity: 1 pc every 50 cm of profile

CALAMITA / MAGNET



CODICE
CODE

- 102050001
- 1020500210

PORTATA
RANGE

- 1 Kg
- 2 Kg

Quantità raccomandata: 1 pz ogni 25cm di profilo
Recommended quantity: 1 pc every 25cm of profile

KIT DI SOSPENSIONE / SUSPENSION KIT

DATI TECNICI
TECHNICAL DATA

ARTICOLI INCLUSI NEL CODICE
ARTICLES INCLUDED IN THE CODE

Cavo in acciaio 2,00m con puntalino
2.00m steel cable with tip
Boccola cromata con regolazione millimetrica
Chrome bush with millimeter adjustment
Archetto in alluminio per sospensione
Aluminum arch for suspension

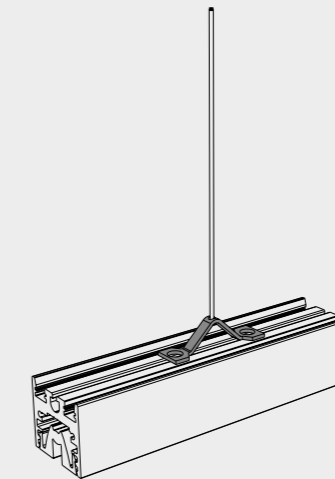

FINITURA STRUTTURA
FINISHES

- GRIGIO VESUVIO ANTHRACITE
- ARGILLA CLAY
- ARGENTO OPACO/MATT SILVER
- BIANCO INTONACO/WHITE
- NERO CARAVAGGIO BLACK
- MOKA MOCHA
- CROMO/CHROME
- ORO CALIFORNIA/GOLD
- ARAMEN COPPER
- GRIGIO AVIO GREY AVIO
- ARGENTO COMETA/SILVER COMET
- OTTONE VENEZIANO BRASS
- TITANIO/TITANIUM
- BRONZO RIACI/RIACI BRONZE
- VERDE COSTA/GREEN COAST
- TERRA SENESE SENESE EARTH

CODICE
CODE



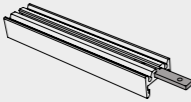
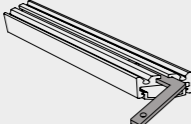

- 1040500004
- 1040501004
- 1040502004
- 1040503004
- 1040504004
- 1040505004
- 1040508004
- 1040509004
- 1040510004
- 1040511004
- 1040512004
- 1040513004
- 1040514004
- 1040515004
- 1040516004
- 1040517004

GIUNTI / JOINTS

		FINITURA FINISHES	CODICE CODE
GIUNTO LINEA CONTINUA / STRAIGHT JOINT Accessorio per giunzioni meccaniche lineari Accessory for linear mechanical joints		ALLUMINIO NATURALE/ALUMINUM	1010500006
GIUNTO 90° ORIZZONTALE / HORIZONTAL JOINT 90° Accessorio per giunzioni meccaniche con angolo 90° Accessory for linear mechanical joints with 90° angle		ALLUMINIO NATURALE/ALUMINUM	1010500005

Nel codice sono compresi i grani per il fissaggio del giunto
The code includes the grains for fixing the joint.

LAVORAZIONI / PROCESSING

	DATI TECNICI TECHNICAL DATA	CODICE CODE
	TAGLIO 90° ORIZZONTALE (PER ANGOLI FORMATI DA DUE PROFILI) HORIZONTAL 90 ° CUT (FOR CORNERS MADE OF TWO PROFILES)	190X
	TAGLIO ANGOLARE CUSTOM (PER ANGOLI FORMATI DA DUE PROFILI) CUSTOM CORNER CUT (FOR CORNERS MADE OF TWO PROFILES)	190N
	ASOLA / SLOT	100A
	FORO / HOLE	100F
	CAVO DI ALIMENTAZIONE 2X0,75 TONDO TRASPARENTE 1CM POWER CABLE 2X0,75 ROUND TRANSPARENT 1CM	98CTT001

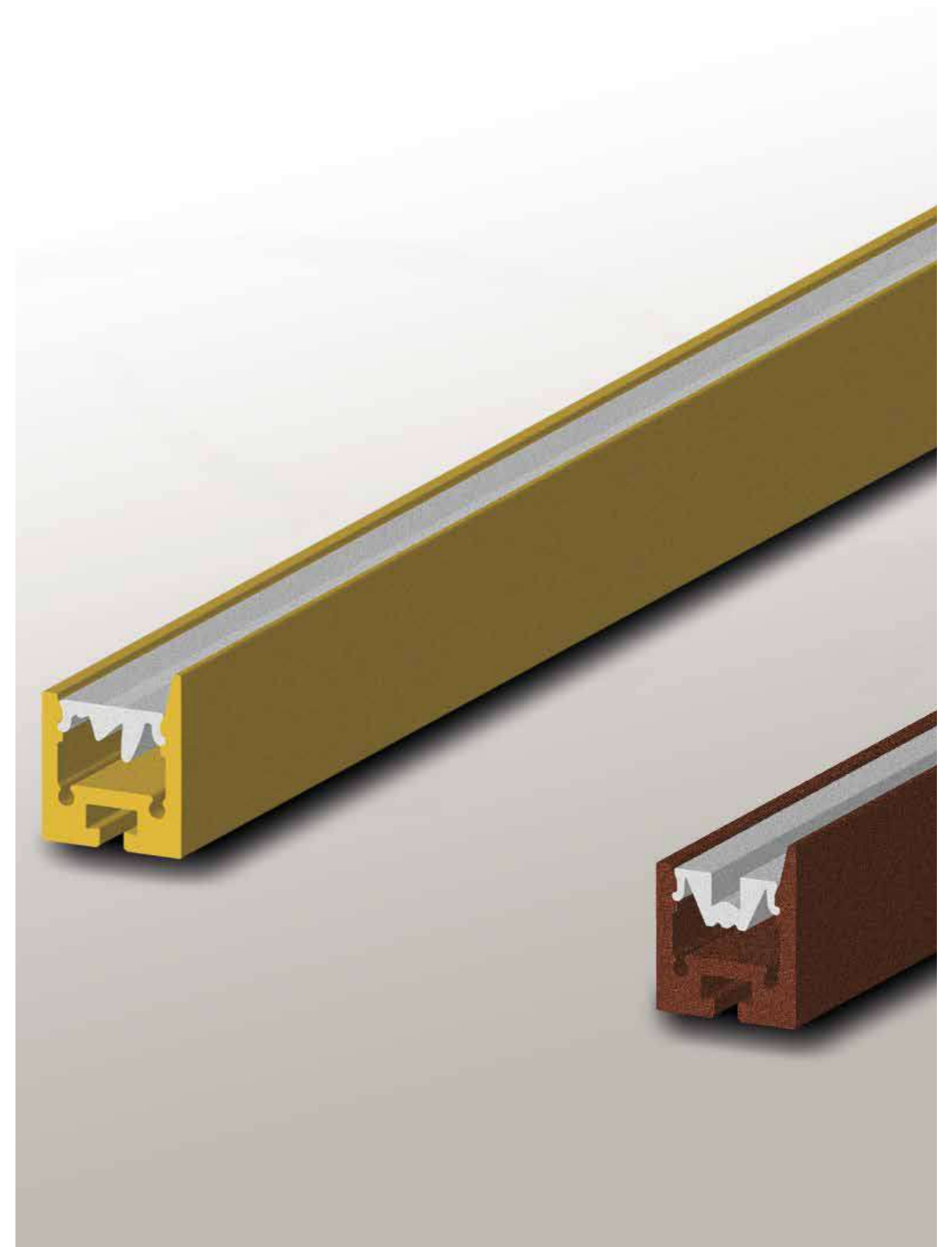

“altissimi livelli qualitativi e prestazionali”

La luce naturale incentiva la comunicazione il benessere e regola i ritmi biologici della vita. È la nostra risposta nella ricerca continua di creare una luce che trasmetta sensazioni stimolanti, aiuti nell'orientamento ed esprima qualità, soprattutto quando le architetture raggiungono altissimi livelli qualitativi e prestazionali. Q20 contribuisce a tutto questo grazie alle sue lenti e alla tecnologia led appositamente progettata per garantire la possibilità di studiare e personalizzare ogni tipo di progetto commerciale, museale.

Q20 Natural light stimulates communication, well-being and regulates the biological rhythms of life. It is our response in the continuous search to create a light that transmits stimulating sensations, helps in orientation and expresses quality, especially when the architectures reach the highest quality and performance levels. Q20 contributes to all this thanks to its lenses and LED technology specially designed to guarantee the possibility of studying and customizing any type of commercial, museum project.





VERSIONE SPOT (15°)
SPOT VERSION (15°)

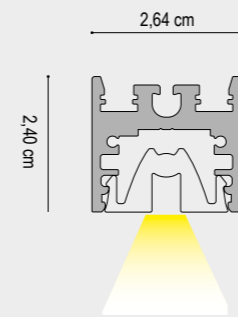

VERSIONE WALL WASHER (45°)
WALL WASHER VERSION (45°)

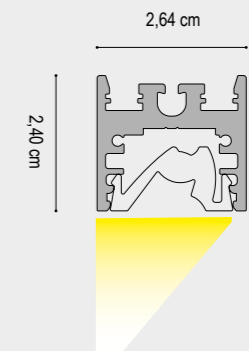

LE CONFIGURAZIONI RIPORTATE SONO COMPATIBILI PER LA VERSIONE SPOT E PER LA VERSIONE WALL WASHER.
THE CONFIGURATIONS SHOWN ARE COMPATIBLE FOR THE SPOT VERSION AND FOR THE WALL WASHER VERSION.

INSTALLAZIONE A SOSPENSIONE
SUSPENSION

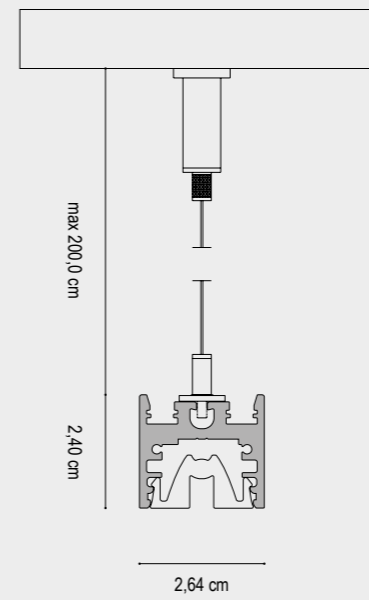

INSTALLAZIONE CON CLIP IN POLICARBONATO SU
SUPERFICIE ORIZZONTALE
INSTALLATION WITH POLYCARBONATE CLIP ON HORIZONTAL
SURFACE

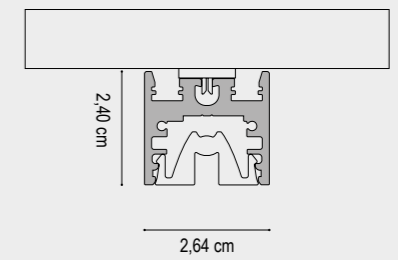

INSTALLAZIONE CON STAFFE MAGNETICHE SU SUPERFICIE METALLICA ORIZZONTALE
INSTALLATION WITH MAGNET ON HORIZONTAL METAL SURFACE

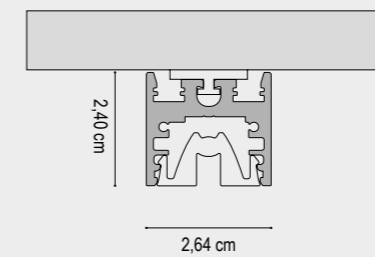

SI RACCOMANDA L'UTILIZZO DI N° 1 STAFFA
MAGNETICA OGNI 25,00 cm DI PROFILO. TALE
QUANTITÀ PUÒ VARIARE A SECONDA DELLA
SUPERFICIE METALLICA DI INSTALLAZIONE.

WE RECOMMEND THE USE OF N° 1 MAGNETIC
BRACKET EVERY 25.00 cm OF PROFILE.
THIS QUANTITY MAY VARY DEPENDING ON
THE METAL INSTALLATION SURFACE.

q20 — spot

led integrato

integrated led

q20 — wall washer

led integrato

integrated led

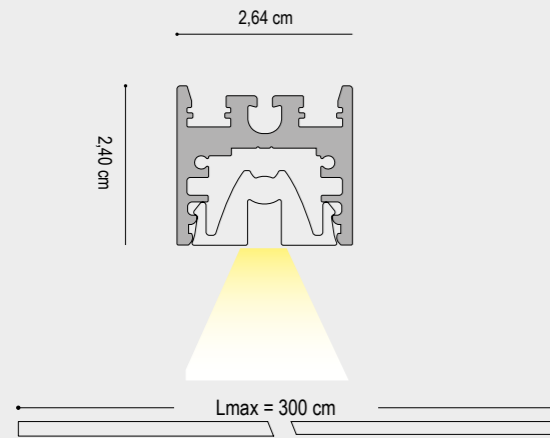

DATI TECNICI TECHNICAL DATA	
1 cm - 30W/m	
Nominal LED Flux:	4440 lm/m
Flux Tot:	3552 lm/m
Output:	148 lm/W
CCT:	3000 K
CRI:	>90
Power Tot:	30.0W/m
Weight:	0.60 Kg/m
Profilo/Profile:	Alluminio/aluminum
Lente/Lens:	15°
DRIVER NON INCLUSO / NOT INCLUDED	
CAVO ALIMENTAZIONE: 50 cm ALIMENTATION CABLE: 50 cm	

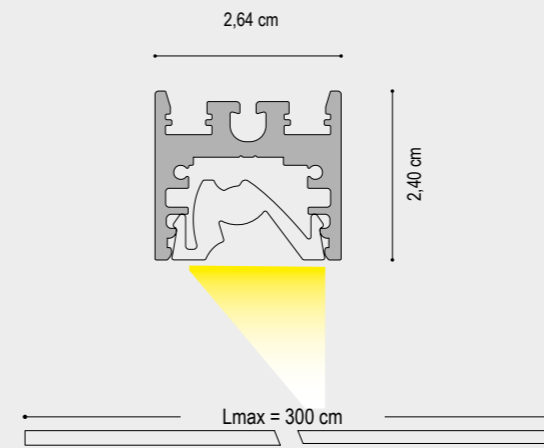

DATI TECNICI TECHNICAL DATA	
1 cm - 30W/m	
Nominal LED Flux:	4440 lm/m
Flux Tot:	3552 lm/m
Output:	148 lm/W
CCT:	3000 K
CRI:	>90
Power Tot:	30.0W/m
Weight:	0.60 Kg/m
Profilo/Profile:	Alluminio/aluminum
Lente/Lens:	45°
DRIVER NON INCLUSO / NOT INCLUDED	
CAVO ALIMENTAZIONE: 50 cm ALIMENTATION CABLE: 50 cm	

FINITURA STRUTTURA
FINISHES

- GRIGIO VESUVIO ANTHRACITE
- ARGILLA CLAY
- ARGENTO OPACO MATT SILVER
- BIANCO INTONACO WHITE
- NERO CARAVAGGIO BLACK
- MOKA MOCHA
- CROMO CHROME
- ORO CALIFORNIA GOLD
- ARAMEN COPPER
- ARGENTO COMETA SILVER COMET
- OTTONE VENEZIANO VENETIAN BRASS
- TITANIO TITANIUM
- BRONZO RIACI RIACI BRONZE
- VERDE COSTA GREEN COAST
- TERRA SENESE SENESE EARTH

DIFFUSORE
DIFFUSER

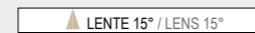

1 cm - 30W/m

CODICE
CODE

- 298100S001
- 298101S001
- 298102S001
- 298103S001
- 298104S001
- 298105S001
- 298108S001
- 298109S001
- 298110S001
- 298112S001
- 298113S001
- 298114S001
- 298115S001
- 298116S001
- 298117S001

N.B./P.N.: LUNGHEZZA MASSIMA VERSIONE CROMO = 2,00 m / MAXIMUM LENGTH CHROME VERSION = 2.00 m
TESTATE DI CHIUSURA NON INCLUSE / DEAD ENDS NOT INCLUDED

DIAGRAMMA FOTOMETRICO
LENTE SPOT - 15°

PHOTOMETRIC DIAGRAM
SPOT LENS - 15°

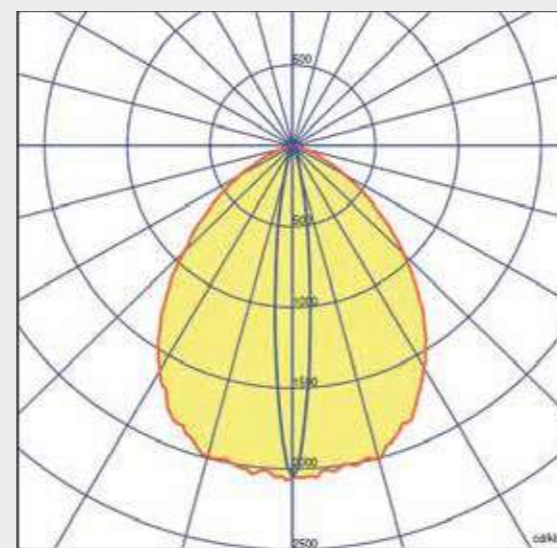

FINITURA STRUTTURA
FINISHES

- GRIGIO VESUVIO ANTHRACITE
- ARGILLA CLAY
- ARGENTO OPACO MATT SILVER
- BIANCO INTONACO WHITE
- NERO CARAVAGGIO BLACK
- MOKA MOCHA
- CROMO CHROME
- ORO CALIFORNIA GOLD
- ARAMEN COPPER
- ARGENTO COMETA SILVER COMET
- OTTONE VENEZIANO VENETIAN BRASS
- TITANIO TITANIUM
- BRONZO RIACI RIACI BRONZE
- VERDE COSTA GREEN COAST
- TERRA SENESE SENESE EARTH

DIFFUSORE
DIFFUSER

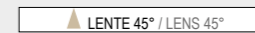

1 cm - 30W/m

CODICE
CODE

- 298100W001
- 298101W001
- 298102W001
- 298103W001
- 298104W001
- 298105W001
- 298108W001
- 298109W001
- 298110W001
- 298112W001
- 298113W001
- 298114W001
- 298115W001
- 298116W001
- 298117W001

N.B./P.N.: LUNGHEZZA MASSIMA VERSIONE CROMO = 2,00 m / MAXIMUM LENGTH CHROME VERSION = 2.00 m
TESTATE DI CHIUSURA NON INCLUSE / DEAD ENDS NOT INCLUDED

DIAGRAMMA FOTOMETRICO
LENTE WALL WASHER - 45°

PHOTOMETRIC DIAGRAM
WALL WASHER LENS - 45°

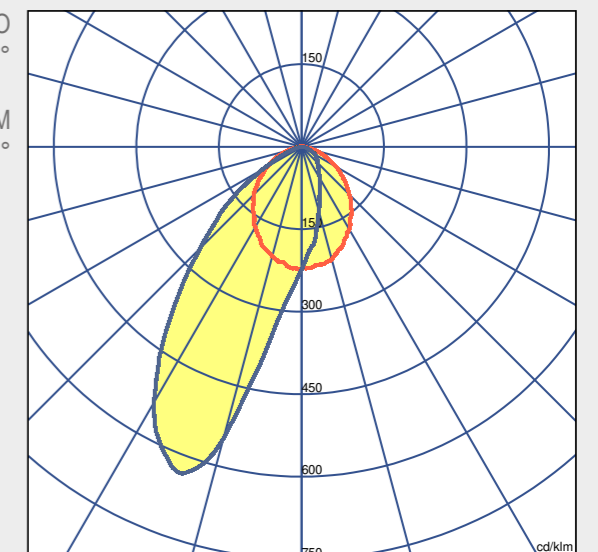

DATI TECNICI
TECHNICAL DATA

	1 cm - 24W/m
Nominal LED Flux:	2160 lm/m
Flux Tot:	1728 lm/m
Output:	90 lm/W
CCT:	3000 K
CRI:	>90
Power Tot:	24.0W/m (700 LED/m)
Weight:	0.60 Kg/m

Profilo/Profile: Alluminio/aluminum Cover: Opale/opal

DRIVER NON INCLUSO / NOT INCLUDED CAVO ALIMENTAZIONE: 50 cm
ALIMENTATION CABLE: 50 cm

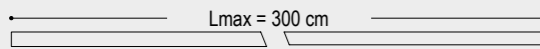
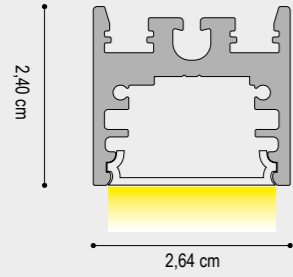

1 cm - 30W/m

FINITURA STRUTTURA
FINISHES

- GRIGIO VESUVIO ANTHRACITE
- ARGILLA CLAY
- ARGENTO OPACO/MATT SILVER
- BIANCO INTONACO/WHITE
- NERO CARAVAGGIO BLACK
- MOKA MOCHA
- CROMO CHROME
- ORO CALIFORNIA/GOLD
- ARAMEN COPPER
- ARGENTO COMETA/SILVER COMET
- OTTONE VENEZIANO VENETIAN BRASS
- TITANIO/TITANIUM
- BRONZO RIACI/RIACI BRONZE
- VERDE COSTA/GREEN COAST
- TERRA SENESE SENESE EARTH

DIFFUSORE
DIFFUSER

OPALE/OPAL

CODICE
CODE

- 297300C001
- 297301C001
- 297302C001
- 297303C001
- 297304C001
- 297305C001
- 297308C001
- 297309C001
- 297310C001
- 297312C001
- 297313C001
- 297314C001
- 297315C001
- 297316C001
- 297317C001

DIFFUSORE
DIFFUSER

PRISMATIZZATO
PRISMATIC

CODICE
CODE

- 297300Z001
- 297301Z001
- 297302Z001
- 297303Z001
- 297304Z001
- 297305Z001
- 297308Z001
- 297309Z001
- 297310Z001
- 297312Z001
- 297313Z001
- 297314Z001
- 297315Z001
- 297316Z001
- 297317Z001

N.B./P.N.: LUNGHEZZA MASSIMA VERSIONE CROMO = 2,00 m / MAXIMUM LENGTH CHROME VERSION = 2.00 m
TESTATE DI CHIUSURA NON INCLUSE / DEAD ENDS NOT INCLUDED

DIAGRAMMA FOTOMETRICO
DIFFUSORE IN POLICARBONATO OPALE

PHOTOMETRIC DIAGRAM
OPAL POLYCARBONATE DIFFUSER

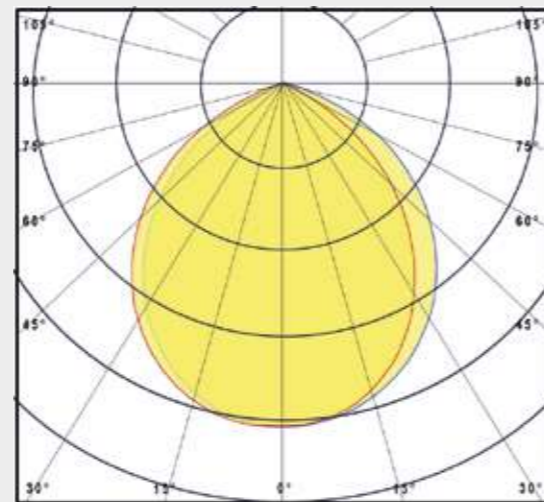

LENTE WALL WASHER - 45°
WALL WASHER LENS - 45°

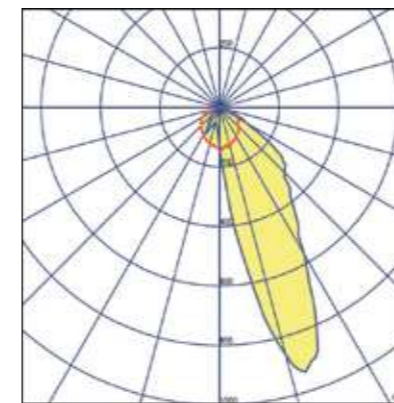

LENTE SPOT - 15°
SPOT LENS - 15°

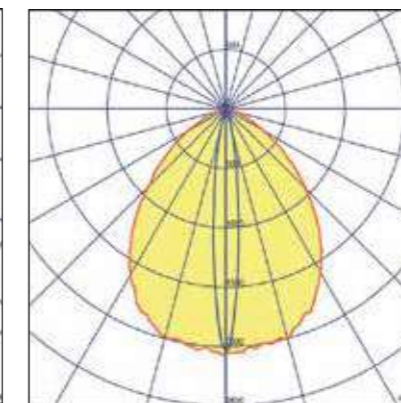

DIFFUSORE IN POLICARBONATO OPALE
OPAL POLYCARBONATE DIFFUSER

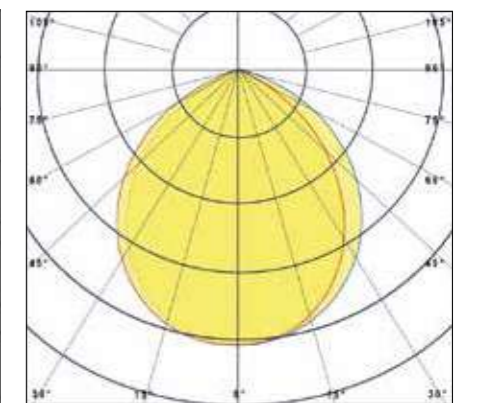

TESTATE DI CHIUSURA / DEAD ENDS

FINITURA STRUTTURA FINISHES	CODICE CODE	FINITURA STRUTTURA FINISHES	CODICE CODE
GRIGIO VESUVIO ANTHRACITE	290400	ARAMEN COPPER	290410
ARGILLA CLAY	290401	GRIGIO AVIO GREY AVIO	290411
ARGENTO OPACO MATT SILVER	290402	ARGENTO COMETA/SILVER COMET	290412
BIANCO INTONACO/WHITE	290403	OTTONE VENEZIANO BRASS	290413
NERO CARAVAGGIO BLACK	290404	TITANIO/TITANIUM	290414
MOKA MOCHA	290405	BRONZO RIACI/RIACI BRONZE	290415
CROMO/CHROME	290408	VERDE COSTA/GREEN COAST	290416
ORO CALIFORNIA/GOLD	290409	TERRA SENESE SENESE EARTH	290417

Nel codice sono comprese le viti per il fissaggio delle testate al profilo. Il codice contiene n° 1 testate di chiusura. / The code includes the screws for fixing the heads to the profile. The code contains 1 closing warheads

STAFFA DI FISSAGGIO / MOUNTING CLIP

FINITURA FINISHES	CODICE CODE
SUPERFICI PIANE 2mm EVEN SURFACE 2mm	1020500003
SUPERFICI IRREGOLARI 3,5mm UNEVEN SURFACE 3,5mm	1020500004

Accessorio per fissaggio a plafone/superficie. Quantità raccomandata: 1 pz ogni 50 cm di profilo
Ceiling/surface mounting accessory. Recommended quantity: 1 pc every 50 cm of profile

CALAMITA / MAGNET

CODICE CODE	PORTATA RANGE
102050001	1 Kg
1020500210	2 Kg

Quantità raccomandata: 1 pz ogni 25cm di profilo
Recommended quantity: 1 pc every 25cm of profile

KIT DI SOSPENSIONE / SUSPENSION KIT

DATI TECNICI TECHNICAL DATA	FINITURA STRUTTURA FINISHES	CODICE CODE
ARTICOLI INCLUSI NEL CODICE ARTICLES INCLUDED IN THE CODE Cavo in acciaio 2,00m con puntalino 2.00m steel cable with tip Boccola cromata con regolazione millimetrica Chrome bush with millimeter adjustment Archetto in alluminio per sospensione Aluminum arch for suspension	GRIGIO VESUVIO ANTHRACITE	1040500004
	ARGILLA CLAY	1040501004
	ARGENTO OPACO MATT SILVER	1040502004
	BIANCO INTONACO/WHITE	1040503004
	NERO CARAVAGGIO BLACK	1040504004
	MOKA MOCHA	1040505004
	CROMO/CHROME	1040508004
	ORO CALIFORNIA/GOLD	1040509004
	ARAMEN COPPER	1040510004
	GRIGIO AVIO GREY AVIO	1040511004
	ARGENTO COMETA/SILVER COMET	1040512004
	OTTONE VENEZIANO BRASS	1040513004
	TITANIO/TITANIUM	1040514004
	BRONZO RIACI/RIACI BRONZE	1040515004
	VERDE COSTA/GREEN COAST	1040516004
	TERRA SENESE SENESE EARTH	1040517004

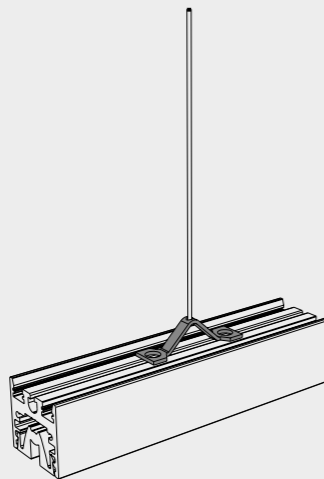

GIUNTI / JOINTS

	FINITURA FINISHES	CODICE CODE
GIUNTO LINEA CONTINUA / STRAIGHT JOINT Accessorio per giunzioni meccaniche lineari Accessory for linear mechanical joints	ALLUMINIO NATURALE/ALUMINUM	1010500006
GIUNTO 90° ORIZZONTALE / HORIZONTAL JOINT 90° Accessorio per giunzioni meccaniche con angolo 90° Accessory for linear mechanical joints with 90° angle	ALLUMINIO NATURALE/ALUMINUM	1010500005

Nel codice sono compresi i grani per il fissaggio del giunto
The code includes the grains for fixing the joint.

LAVORAZIONI / PROCESSING

DATI TECNICI TECHNICAL DATA	CODICE CODE
 TAGLIO 90° ORIZZONTALE (PER ANGOLI FORMATI DA DUE PROFILI) HORIZONTAL 90 ° CUT (FOR CORNERS MADE OF TWO PROFILES)	190X
 TAGLIO ANGOLARE CUSTOM (PER ANGOLI FORMATI DA DUE PROFILI) CUSTOM CORNER CUT (FOR CORNERS MADE OF TWO PROFILES)	190N
 ASOLA / SLOT ASOLA CUSTOM/ SLOT CUSTOM	100A 100N
 FORO / HOLE	100F
 CAVO DI ALIMENTAZIONE 2X0,75 TONDO TRASPARENTE 1CM POWER CABLE 2X0,75 ROUND TRANSPARENT 1CM	98CTT001

“articolata serie di soluzioni”

La selezione di ottiche e schermi disponibili è stata studiata per offrire un'articolata serie di soluzioni, ognuna adatta a realizzare scenografi e luminose negli ambienti, senza trascurare il comfort visivo e garantendo la valorizzazione degli spazi. STRUCTURAE, grazie all'ampia gamma di accessori, permette di realizzare infinite combinazioni e di adattarsi ad ogni esigenza, rispettando il design di tutti i contesti.

The large selection of cover and optics are designed to offer infinite solutions, each of that can realize wonderful light scenes in the environments without overlook the visual comfort and at the same time exalting the spaces. According to the high disposability of accessories, STRUCTURAE could realize lot of combinations and could be adapted to the needs of everyone, respecting the design everywhere.



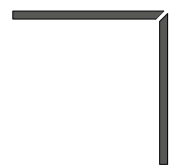

A. COMPOSIZIONE ANGOLARE A "L"
A. L-ANGLE COMPOSITION

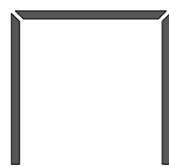

B. COMPOSIZIONE ANGOLARE A "C"
B. C-ANGLE COMPOSITION

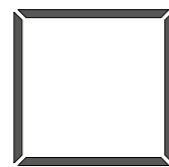

C. COMPOSIZIONE POLIGONALE (QUADRATO/RETTANGOLO)
C. POLYGONAL COMPOSITION (SQUARE / RECTANGLE)



D. COMPOSIZIONE POLIGONALE (PENTAGONO/ESAGONO)
D. POLYGONAL COMPOSITION (PENTAGON / HEX)

INSTALLAZIONE A SOSPENSIONE
SUSPENSION

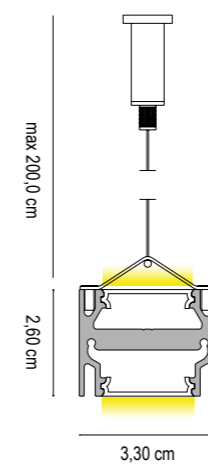

INSTALLAZIONE A PARETE
WALL INSTALLATION

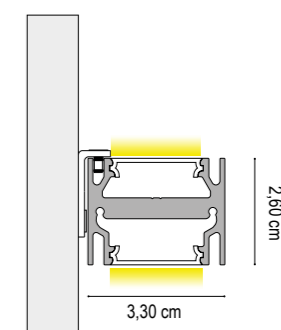

structurae

led integrato

integrated led

DATI TECNICI
TECHNICAL DATA

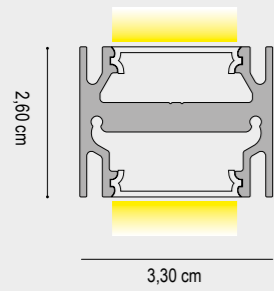

	1 cm - 40W/m	200 cm - 80W	300 cm - 120W
Nominal LED Flux:	↑2200 lm/m - 2200 lm/m ↓	↑4400 lm - 4400 lm ↓	↑6600 lm - 6600 lm ↓
Flux Tot:	↑1760 lm/m - 1760 lm/m ↓	↑3520 lm - 3520 lm ↓	↑5280 lm - 5280 lm ↓
Output:	110 lm/W	110 lm/W	110 lm/W
CCT:	3000 K	3000 K	3000 K
CRI:	>95	>95	>95
Power:	↑19.2W/m - 19.2W/m ↓	↑38.4W - 38.4W ↓	↑57.6W - 57.6W ↓
Power Tot:	38.4W/m	76.8W	115.2W
Weight:	1.40 Kg/m	2.80 Kg	4.20 Kg

Profilo/Profile: Alluminio/aluminum Satin

Cover: Opale/opal - Satinato/Satin

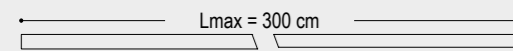

DRIVER NON INCLUSO / NOT INCLUDED

CAVO ALIMENTAZIONE: 50 cm
ALIMENTATION CABLE: 50 cm

structurae

led integrato

integrated led

DATI TECNICI
TECHNICAL DATA

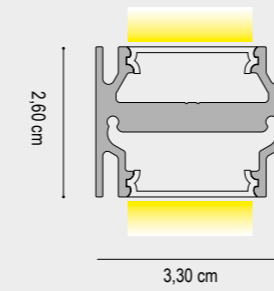

	1 cm - 40W/m	200 cm - 80W	300 cm - 120W
Nominal LED Flux:	↑4440 lm/m - 4440 lm/m ↓	↑8880 lm - 8880 lm ↓	↑13320 lm - 13320 lm ↓
Flux Tot:	↑3552 lm/m - 3552 lm/m ↓	↑7104 lm - 7104 lm ↓	↑10656 lm - 10656 lm ↓
Output:	148 lm/W	148 lm/W	148 lm/W
CCT:	3000 K	3000 K	3000 K
CRI:	>90	>90	>90
Power:	↑30.0W/m - 30.0W/m ↓	↑60.0W - 60.0W ↓	↑90.0W - 90.0W ↓
Power Tot:	60.0W/m	120.0W	180.0W
Weight:	1.40 Kg/m	2.80 Kg	4.20 Kg

Profilo/Profile: Alluminio/aluminum

Cover: Opale/opal - Satinato/Satin

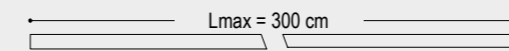

DRIVER NON INCLUSO / NOT INCLUDED

CAVO ALIMENTAZIONE: 50 cm
ALIMENTATION CABLE: 50 cm

FINITURA STRUTTURA
FINISHES

- GRIGIO VESUVIO ANTHRACITE
- ARGILLA ARGIL
- ARGENTO OPACO/MATT SILVER
- BIANCO INTONACO/WHITE
- NERO CARAVAGGIO/BLACK
- MOKA MOCHA
- ORO CALIFORNIA/GOLD
- ARAMEN COPPER
- GRIGIO AVIO/ GREY AVIO
- ARGENTO COMETA/SILVER COMET
- OTTONE VENEZIANO/BRASS
- TITANIO/TITANIUM
- BRONZO RIACI/RIACI BRONZE
- VERDE COSTA/GREEN COAST
- TERRA SENESE SENESE EARTH
- CROMO/CHROME

DIFFUSORE
DIFFUSER

- SATINATA/SATIN
- OPALE/OPAL

	1 cm	200 cm	300 cm
CODICE CODE	CODICE CODE	CODICE CODE	CODICE CODE
1042600001	1042600200	1042600300	
1042601001	1042601200	1042601300	
1042602001	1042602200	1042602300	
1042603001	1042603200	1042603300	
1042604001	1042604200	1042604300	
1042605001	1042605200	1042605300	
1042609001	1042609200	1042609300	
1042610001	1042610200	1042610300	
1042611001	1042611200	1042611300	
1042612001	1042612200	1042612300	
1042613001	1042613200	1042613300	
1042614001	1042614200	1042614300	
1042615001	1042615200	1042615300	
1042616001	1042616200	1042616300	
1042617001	1042617200	1042617300	
1042608001	1042608200		

N.B./P.N.:

LUNGHEZZA MASSIMA VERSIONE CROMO = 2,00 m / MAXIMUM LENGTH CHROME VERSION = 2.00 m
TESTATE DI CHIUSURA NON INCLUSE / DEAD ENDS NOT INCLUDED

FINITURA STRUTTURA
FINISHES

- GRIGIO VESUVIO ANTHRACITE
- ARGILLA ARGIL
- ARGENTO OPACO/MATT SILVER
- BIANCO INTONACO/WHITE
- NERO CARAVAGGIO/BLACK
- MOKA MOCHA
- ORO CALIFORNIA/GOLD
- ARAMEN COPPER
- GRIGIO AVIO/ GREY AVIO
- ARGENTO COMETA/SILVER COMET
- OTTONE VENEZIANO/BRASS
- TITANIO/TITANIUM
- BRONZO RIACI/RIACI BRONZE
- VERDE COSTA/GREEN COAST
- TERRA SENESE SENESE EARTH
- CROMO/CHROME

DIFFUSORE
DIFFUSER

- SATINATA/SATIN
- OPALE/OPAL

	1 cm	200 cm	300 cm
CODICE CODE	CODICE CODE	CODICE CODE	CODICE CODE
1048100001	1048100200	1048100300	
1048101001	1048101200	1048101300	
1048102001	1048102200	1048102300	
1048103001	1048103200	1048103300	
1048104001	1048104200	1048104300	
1048105001	1048105200	1048105300	
1048109001	1048109200	1048109300	
1048110001	1048110200	1048110300	
1048111001	1048111200	1048111300	
1048112001	1048112200	1048112300	
1048113001	1048113200	1048113300	
1048114001	1048114200	1048114300	
1048115001	1048115200	1048115300	
1048116001	1048116200	1048116300	
1048117001	1048117200	1048117300	
1048108001	1048108200		

N.B./P.N.:

LUNGHEZZA MASSIMA VERSIONE CROMO = 2,00 m / MAXIMUM LENGTH CHROME VERSION = 2.00 m
TESTATE DI CHIUSURA NON INCLUSE / DEAD ENDS NOT INCLUDED





FINITURA STRUTTURA FINISHES

- GRIGIO VESUVIO ANTHRACITE
- ARGILLA ARGIL
- ARGENTO OPACO/MATT SILVER
- BIANCO INTONACO/WHITE
- NERO CARAVAGGIO BLACK
- MOKA MOCHA
- ORO CALIFORNIA/GOLD
- ARAMEN COPPER
- GRIGIO AVIO/GREY AVIO
- ARGENTO COMETA/SILVER COMET
- OTTONE VENEZIANO BRASS
- TITANIO/TITANIUM
- BRONZO RIACI/RIACI BRONZE
- VERDE COSTA/GREEN COAST
- TERRA SENESE SENESE EARTH
- CROMO/CHROME

	1 cm	200 cm	300 cm
CODICE CODE	CODICE CODE	CODICE CODE	CODICE CODE
1040300001	1040300200	1040300300	1040300300
1040301001	1040301200	1040301300	1040301300
1040302001	1040302200	1040302300	1040302300
1040303001	1040303200	1040303300	1040303300
1040304001	1040304200	1040304300	1040304300
1040305001	1040305200	1040305300	1040305300
1040309001	1040309200	1040309300	1040309300
1040310001	1040310200	1040310300	1040310300
1040311001	1040311200	1040311300	1040311300
1040312001	1040312200	1040312300	1040312300
1040313001	1040313200	1040313300	1040313300
1040314001	1040314200	1040314300	1040314300
1040315001	1040315200	1040315300	1040315300
1040316001	1040316200	1040316300	1040316300
1040317001	1040317200	1040317300	1040317300
1040308001	1040308200		

N.B./P.N.: LUNGHEZZA MASSIMA VERSIONE CROMO = 2,00 m / MAXIMUM LENGTH CHROME VERSION = 2.00 m

LED compatibili / LED compatibility

HIGH QUALITY CRI>90 CRI>95	HIGH OUTPUT CRI>90 CRI>95	HIGH EFFICIENT CRI>90 CRI>95	HIGH INTENSITY CRI>90 CRI>95	LOW POWER CRI>90	ULTRA SLIM CRI>90 CRI>95 CRI>97	RGB	RGB WHITE	RGB TW	TUNABLE WHITE
9,6W 14,4W 19,2W	12,3W 14,4W 19,2W 20W 24W	12,3W 14,4W 19,2W 20W 24W	24W 24W (700 LED)	6W	9,6W 12W 14,4W	14W	14W	14,4W 23W	19,2W

DIFFUSORE

	1 cm	200 cm	300 cm
DIFFUSORE DIFFUSER	CODICE CODE	CODICE CODE	CODICE CODE
OPALE/OPAL	1030100001	1030100200	1030100300
SATINATA/SATIN	1030101001	1030101200	1030101300
PRISMATIZZATO/PRISMATIC	1030113001	1030113200	1030113300

LENTE

	1 cm	200 cm
DIFFUSORE DIFFUSER	CODICE CODE	CODICE CODE
LENTE 45°/LENS 45°	1040245001	1040245200
LENTE 75°/LENS 75°	1040275001	1040275200

L'AMPIEZZA DEL FASCIO LUMINOSO IN USCITA VARIA A SECONDA DELLA DISTANZA TRA IL LED E LA LENTE
THE AMPLITUDE OF THE LIGHT BEAM IN VARIOUS OUTPUTS DEPENDING ON THE DISTANCE BETWEEN THE LED AND THE LENS

TESTATE DI CHIUSURA / DEAD ENDS

FINITURA STRUTTURA FINISHES	CODICE CODE	FINITURA STRUTTURA FINISHES	CODICE CODE
GRIGIO VESUVIO ANTHRACITE	1040400000	ARAMEN COPPER	1040410000
ARGILLA CLAY	1040401000	GRIGIO AVIO/GREY AVIO	1040411000
ARGENTO OPACO/MATT SILVER	1040402000	ARGENTO COMETA/SILVER COMET	1040412000
BIANCO INTONACO/WHITE	1040403000	OTTONE VENEZIANO BRASS	1040413000
NERO CARAVAGGIO BLACK	1040404000	TITANIO/TITANIUM	1040414000
MOKA MOCHA	1040405000	BRONZO RIACI/RIACI BRONZE	1040415000
CROMO/CHROME	1040408000	VERDE COSTA/GREEN COAST	1040416000
ORO CALIFORNIA/GOLD	1040409000	TERRA SENESE SENESE EARTH	1040417000

Nel codice sono comprese le viti per il fissaggio delle testate al profilo. Il codice contiene n° 1 testate di chiusura. / The code includes the screws for fixing the heads to the profile. The code contains 1 closing warheads



GIUNTI / JOINTS

DATI TECNICI
TECHNICAL DATA

GIUNTO LINEA CONTINUA / STRAIGHT JOINT

Accessorio per giunzioni meccaniche lineari
Accessory for linear mechanical joints

Nel codice sono compresi i grani di fissaggio del giunto
The code includes the grains for fixing the joint

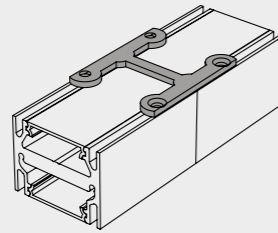

FINITURA STRUTTURA
FINISHES

GRIGIO VESUVIO ANTHRACITE
ARGILLA ARGIL
ARGENTO OPACO/MATT SILVER
BIANCO INTONACO/WHITE
NERO CARAVAGGIO/BLACK
MOKA MOCHA
CROMO CHROME
ORO CALIFORNIA/GOLD
ARAMEN COPPER
GRIGIO AVIO/GREY AVIO
ARGENTO COMETA/SILVER COMET
OTTONE VENEZIANO/BRASS
TITANIO/TITANIUM
BRONZO RIACI/RIACI BRONZE
VERDE COSTA/GREEN COAST
TERRA SENESE SENESE EARTH

CODICE
CODE

1040500001
1040501001
1040502001
1040503001
1040504001
1040505001
1040508001
1040509001
1040510001
1040511001
1040512001
1040513001
1040514001
1040515001
1040516001
1040517001

GIUNTO 90° ORIZZONTALE / HORIZONTAL JOINT 90°

Accessorio per giunzioni meccaniche con angolo 90°
Accessory for linear mechanical joints with 90° angle

Nel codice sono compresi:
N°2 giunti meccanici (inferiore e superiore)
Viti per il fissaggio dei giunti
The code includes:
N° 2 mechanical joints (lower and upper)
Screws for fixing the joints

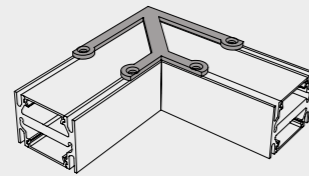

GRIGIO VESUVIO ANTHRACITE
ARGILLA ARGIL
ARGENTO OPACO/MATT SILVER
BIANCO INTONACO/WHITE
NERO CARAVAGGIO/BLACK
MOKA MOCHA
CROMO CHROME
ORO CALIFORNIA/GOLD
ARAMEN COPPER
GRIGIO AVIO/GREY AVIO
ARGENTO COMETA/SILVER COMET
OTTONE VENEZIANO/BRASS
TITANIO/TITANIUM
BRONZO RIACI/RIACI BRONZE
VERDE COSTA/GREEN COAST
TERRA SENESE SENESE EARTH

1040500005
1040501005
1040502005
1040503005
1040504005
1040505005
1040508005
1040509005
1040510005
1040511005
1040512005
1040513005
1040514005
1040515005
1040516005
1040517005

GIUNTO LINEA CONTINUA INTEGRATO A KIT DI SOSPENSIONE /
CONTINUOUS LINE JOINT INTEGRATED TO SUSPENSION KIT

DATI TECNICI
TECHNICAL DATA

Accessorio per giunzioni meccaniche lineari e per
fissaggio a sospensione dei profili.
Accessory for linear mechanical joints and for
suspension fixing of profiles.

ARTICOLI INCLUSI NEL CODICE
ARTICLES INCLUDED IN THE CODE

Cavo in acciaio 2,00m con puntalino
2.00m steel cable with tip
Boccola cromata con regolazione millimetrica
Chrome bush with millimeter adjustment
Giunto meccanico lineare con archetto in alluminio
Linear mechanical joint with aluminum headband

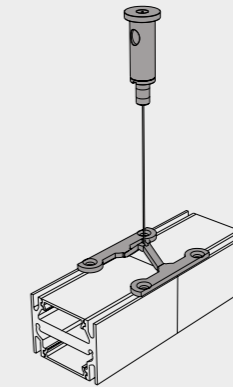

FINITURA STRUTTURA
FINISHES

GRIGIO VESUVIO ANTHRACITE
ARGILLA ARGIL
ARGENTO OPACO/MATT SILVER
BIANCO INTONACO/WHITE
NERO CARAVAGGIO/BLACK
MOKA MOCHA
CROMO CHROME
ORO CALIFORNIA/GOLD
ARAMEN COPPER
GRIGIO AVIO/GREY AVIO
ARGENTO COMETA/SILVER COMET
OTTONE VENEZIANO/BRASS
TITANIO/TITANIUM
BRONZO RIACI/RIACI BRONZE
VERDE COSTA/GREEN COAST
TERRA SENESE SENESE EARTH

CODICE
CODE

1040500003
1040501003
1040502003
1040503003
1040504003
1040505003
1040508003
1040509003
1040510003
1040511003
1040512003
1040513003
1040514003
1040515003
1040516003
1040517003

KIT DI SOSPENSIONE / SUSPENSION KIT

DATI TECNICI
TECHNICAL DATA

ARTICOLI INCLUSI NEL CODICE
ARTICLES INCLUDED IN THE CODE

Cavo in acciaio 2,00m con puntalino
2.00m steel cable with tip
Boccola cromata con regolazione millimetrica
Chrome bush with millimeter adjustment
Archetto in alluminio per sospensione
Aluminum arch for suspension

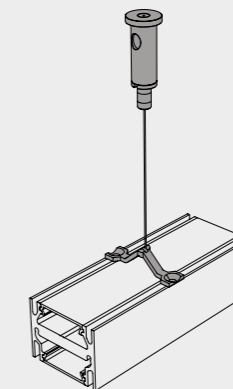

FINITURA STRUTTURA
FINISHES

GRIGIO VESUVIO ANTHRACITE
ARGILLA ARGIL
ARGENTO OPACO/MATT SILVER
BIANCO INTONACO/WHITE
NERO CARAVAGGIO/BLACK
MOKA MOCHA
CROMO CHROME
ORO CALIFORNIA/GOLD
ARAMEN COPPER
GRIGIO AVIO/GREY AVIO
ARGENTO COMETA/SILVER COMET
OTTONE VENEZIANO/BRASS
TITANIO/TITANIUM
BRONZO RIACI/RIACI BRONZE
VERDE COSTA/GREEN COAST
TERRA SENESE SENESE EARTH

CODICE
CODE

1040500004
1040501004
1040502004
1040503004
1040504004
1040505004
1040508004
1040509004
1040510004
1040511004
1040512004
1040513004
1040514004
1040515004
1040516004
1040517004

STAFFA DI FISSAGGIO A PARETE / WALL MOUNTING CLIP

DATI TECNICI
TECHNICAL DATA

MATERIALE: Alluminio naturale
MATERIAL: Natural aluminum

Nel codice è compresa la vite per il fissaggio della staffa al profilo
The code includes the screw for fixing the bracket to the profile

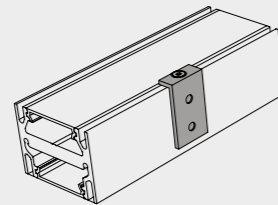

FINITURA STRUTTURA
FINISHES

GRIGIO VESUVIO ANTHRACITE
ARGILLA ARGIL
ARGENTO OPACO MATT SILVER
BIANCO INTONACO/WHITE
NERO CARAVAGGIO BLACK
MOKA MOCHA
CROMO CHROME
ORO CALIFORNIA/GOLD
ARAMEN COPPER
GRIGIO AVIO/GREY AVIO
ARGENTO COMETA/SILVER COMET
OTTONE VENEZIANO BRASS
TITANIO/TITANIUM
BRONZO RIACI/RIACI BRONZE
VERDE COSTA/GREEN COAST
TERRA SENESE SENESE EARTH

CODICE
CODE

104050002
1040501002
1040502002
1040503002
1040504002
1040505002
1040508002
1040509002
1040510002
1040511002
1040512002
1040513002
1040514002
1040515002
1040516002
1040517002

LAVORAZIONI / PROCESSING

DATI TECNICI
TECHNICAL DATA

CODICE
CODE



TAGLIO 90° ORIZZONTALE (PER ANGOLI FORMATI DA DUE PROFILI)
HORIZONTAL 90 ° CUT (FOR CORNERS MADE OF TWO PROFILES)

190X



TAGLIO ANGOLARE CUSTOM (PER ANGOLI FORMATI DA DUE PROFILI)
CUSTOM CORNER CUT (FOR CORNERS MADE OF TWO PROFILES)

190N



ASOLA / SLOT

100A



ASOLA CUSTOM / SLOT CUSTOM

100N



FORO / HOLE

100F



CABLAGGIO - COLLAUDO - CE AL CENTIMETRO
INSTALLATION AND TESTING LED MODULE AT CENTIMETER

1041



CONNETTORE MASCHIO/FEMMINA
MALE/FEMALE CONNECTOR

98CFM

CONNETTORE MASCHIO/FEMMINA MONTATO NEL PRODOTTO
MALE/FEMALE CONNECTOR FITTED IN THE PRODUCT

98MFM

CAVO DI ALIMENTAZIONE 2X0,75 TONDO TRASPARENTE 1CM
POWER CABLE 2X0,75 ROUND TRANSPARENT 1CM

98CTT001

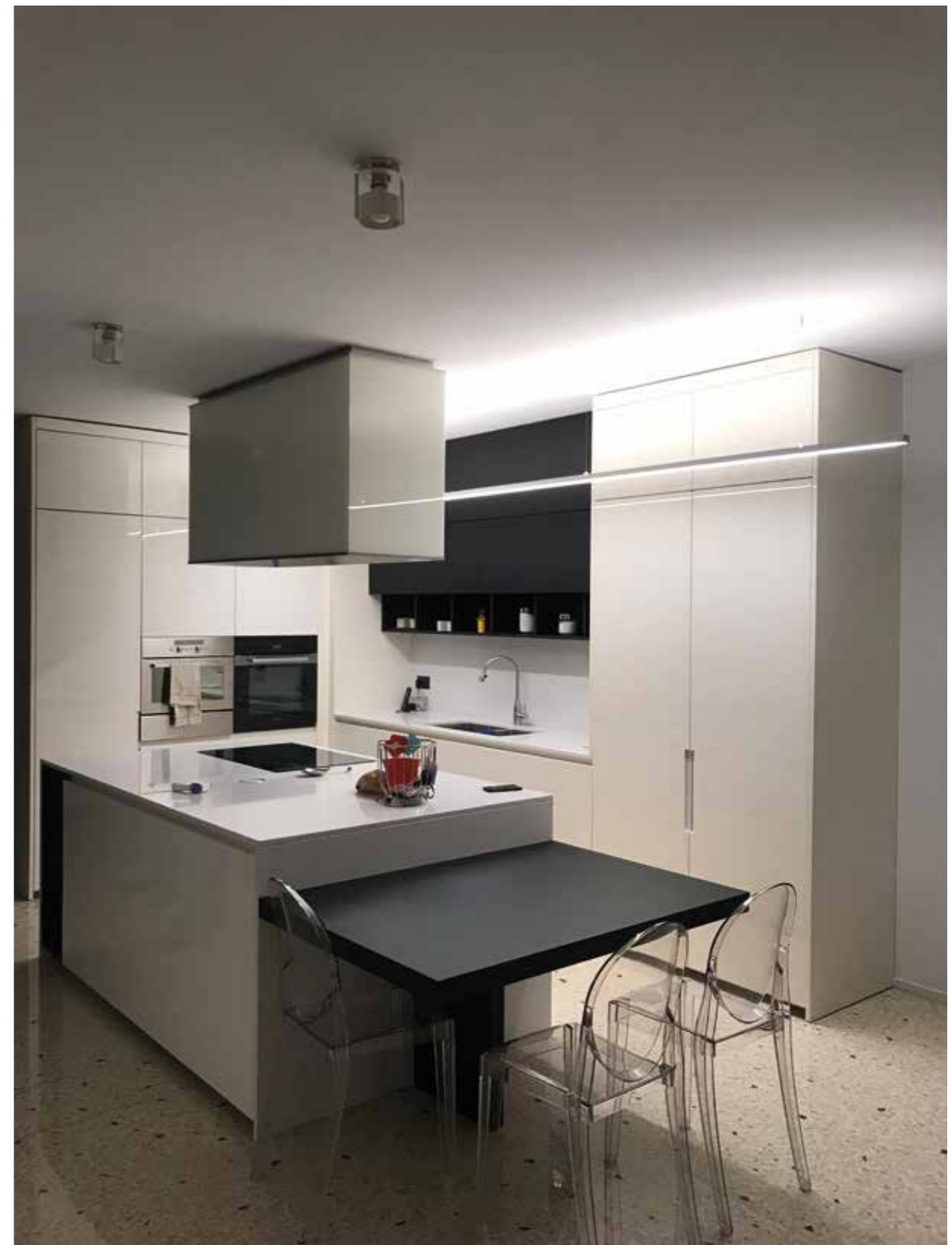

“basse luminanze, elevati CRI”

La nuova famiglia K è il risultato di lavoro duro, dedizione, talento, entusiasmo e passione che ogni persona nella nostra azienda ha messo in questo straordinario progetto, permettendoci di presentare a tutta la nostra clientela nazionale ed internazionale profili evoluti. Design Luce è stata la prima azienda italiana a proporre una gamma con elevate prestazioni, personalità, bellezza e qualità tipiche del made in Italy. K40 è stato pensato per integrare al suo interno elementi ottici, consentendoci di ottenere basse luminanze e impiegare al meglio sorgenti luminose a led di ultima generazione con elevati CRI fino a 95 e con la più alta efficienza energetica (fino a 150lm/W). La gamma di finiture, la personalizzazione del progetto, caratteristica ormai consolidate della nostra azienda, rendono questa famiglia uno strumento indispensabile per il progettista.

The new range of “K” products is the outcome of hard work, dedication, talent, enthusiasm and passion that the staff of Design Luce dedicated to this extraordinary project. Design Luce is now the first Italian company able to offer advanced aluminum lighting profiles with high performance, personality, beauty and quality typical of Made in Italy. K40 is designed to integrate excellent optical and thermal elements to allowing to use at the best the performance of the last generations of LED light sources with CRI up to 95 and the highest energy efficiency (up to 150 lm/W). The range of finishes, the customization of the project, a well-established feature of our company, make this family an indispensable tool for designers and architects.



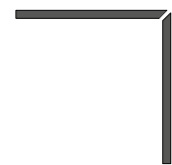
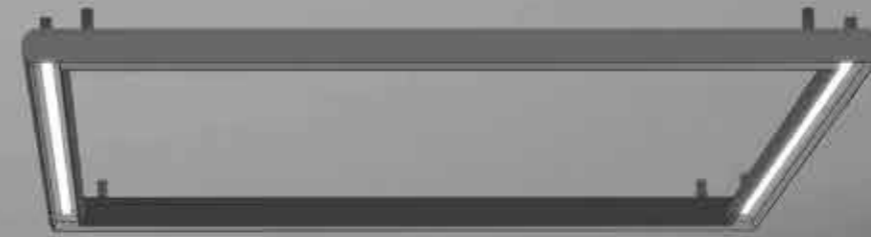

A. COMPOSIZIONE ANGOLARE A "L"
A. L-ANGLE COMPOSITION

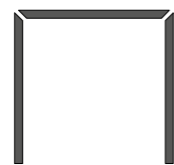

B. COMPOSIZIONE ANGOLARE A "C"
B. C-ANGLE COMPOSITION

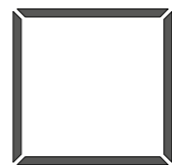

C. COMPOSIZIONE POLIGONALE (QUADRATO/RETTANGOLO)
C. POLYGONAL COMPOSITION (SQUARE / RECTANGLE)

INSTALLAZIONE A SOSPENSIONE PRODOTTO BIEMISSIONE
SUSPENSION BIEMISSION PRODUCT

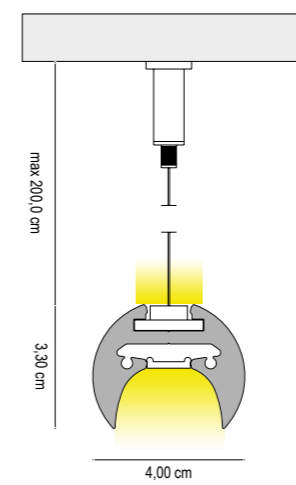

INSTALLAZIONE A SOFFITTO CON DISTANZIALE PRODOTTO MONOEMISSIONE
CEILING INSTALLATION WITH SPACER MONO EMISSION PRODUCT

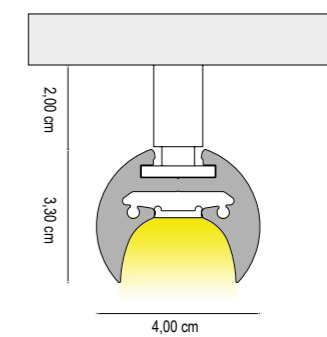

k40

led integrato

integrated led

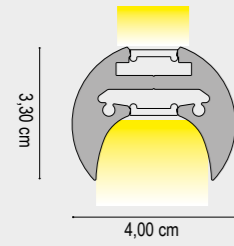

DATI TECNICI
TECHNICAL DATA

	1 cm - 24W/m	1 cm - 40W/m
Nominal LED Flux:	↑ 1900 lm/m - 1900 lm/m ↓	↑ 2200 lm/m - 2200 lm/m ↓
Flux Tot:	↑ 1520 lm/m - 1520 lm/m ↓	↑ 1760 lm/m - 1760 lm/m ↓
Output:	158 lm/W	105 lm/W
CCT:	3000 K	3000 K
CRI:	>90	>90
Power:	↑ 12.0W/m - 12.0W/m ↓	↑ 20.0W/m - 20.0W/m ↓
Power Tot:	24.0W/m	40.0W/m
Weight:	1.40 Kg/m	1.40 Kg/m

Profilo/Profile: Alluminio/aluminum

Cover: Opale/opal - Satinato/Satin

DRIVER NON INCLUSO / NOT INCLUDED

CAVO ALIMENTAZIONE: 50 cm
ALIMENTATION CABLE: 50 cm

Lmax = 300 cm

k40

led integrato

integrated led

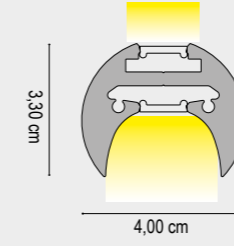

DATI TECNICI
TECHNICAL DATA

	1 cm - 46W/m	1 cm - 60W/m
Nominal LED Flux:	↑ 2520 lm/m - 2520 lm/m ↓	↑ 4440 lm/m - 4440 lm/m ↓
Flux Tot:	↑ 2016 lm/m - 2016 lm/m ↓	↑ 3552 lm/m - 3552 lm/m ↓
Output:	110 lm/W	148 lm/W
CCT:	3000 K	3000 K
CRI:	>90	>90
Power:	↑ 23.0W/m - 23.0W/m ↓	↑ 30.0W/m - 30.0W/m ↓
Power Tot:	46.0W/m	60.0W/m
Weight:	1.40 Kg/m	1.40 Kg/m

Profilo/Profile: Alluminio/aluminum

Cover: Opale/opal - Satinato/Satin

DRIVER NON INCLUSO / NOT INCLUDED

CAVO ALIMENTAZIONE: 50 cm
ALIMENTATION CABLE: 50 cm

Lmax = 300 cm

1 cm - 24W/m

1 cm - 40W/m

1 cm - 46W/m

1 cm - 60W/m

FINITURA STRUTTURA
FINISHES

- GRIGIO VESUVIO ANTHRACITE
- ARGILLA CLAY
- BIANCO INTONACO/WHITE
- NERO CARAVAGGIO/BLACK
- MOKA MOCHA
- CROMO CHROME
- ORO CALIFORNIA/GOLD
- ARAMEN COPPER
- GRIGIO AVIO/GREY AVIO
- OTTONE VENEZIANO/VENETIAN BRASS
- TITANIO/TITANIUM
- BRONZO RIACI/RIACI BRONZE
- VERDE COSTA/GREEN COAST
- TERRA SENESE/SENESE EARTH

DIFFUSORE
DIFFUSER

- SATINATA/SATIN
- OPALE/OPAL

CODICE 2700K CODE 2700K	CODICE 3000K CODE 3000K	CODICE 2700K CODE 2700K	CODICE 3000K CODE 3000K
2054000001	2055000001	2046000001	2047000001
2054010001	2055010001	2046010001	2047010001
2054030001	2055030001	2046030001	2047030001
2054040001	2055040001	2046040001	2047040001
2054050001	2055050001	2046050001	2047050001
2054080001	2055080001	2046080001	2047080001
2054090001	2055090001	2046090001	2047090001
2054100001	2055100001	2046100001	2047100001
2054110001	2055110001	2046110001	2047110001
2054130001	2055130001	2046130001	2047130001
2054140001	2055140001	2046140001	2047140001
2054150001	2055150001	2046150001	2047150001
2054160001	2055160001	2046160001	2047160001
2054170001	2055170001	2046170001	2047170001

N.B./P.N.: LUNGHEZZA MASSIMA VERSIONE CROMO = 2,00 m / MAXIMUM LENGTH CHROME VERSION = 2.00 m
TESTATE DI CHIUSURA NON INCLUSE / DEAD ENDS NOT INCLUDED

FINITURA STRUTTURA
FINISHES

- GRIGIO VESUVIO ANTHRACITE
- ARGILLA CLAY
- BIANCO INTONACO/WHITE
- NERO CARAVAGGIO/BLACK
- MOKA MOCHA
- CROMO CHROME
- ORO CALIFORNIA/GOLD
- ARAMEN COPPER
- GRIGIO AVIO/GREY AVIO
- OTTONE VENEZIANO/VENETIAN BRASS
- TITANIO/TITANIUM
- BRONZO RIACI/RIACI BRONZE
- VERDE COSTA/GREEN COAST
- TERRA SENESE/SENESE EARTH

DIFFUSORE
DIFFUSER

- SATINATA/SATIN
- OPALE/OPAL

CODICE 2700K CODE 2700K	CODICE 3000K CODE 3000K	CODICE 2700K CODE 2700K	CODICE 3000K CODE 3000K
20H6000001	20H7000001	2080000001	2081000001
20H6010001	20H7010001	2080010001	2081010001
20H6030001	20H7030001	2080030001	2081030001
20H6040001	20H7040001	2080040001	2081040001
20H6050001	20H7050001	2080050001	2081050001
20H6080001	20H7080001	2080080001	2081080001
20H6090001	20H7090001	2080090001	2081090001
20H6100001	20H7100001	2080100001	2081100001
20H6110001	20H7110001	2080110001	2081110001
20H6130001	20H7130001	2080130001	2081130001
20H6140001	20H7140001	2080140001	2081140001
20H6150001	20H7150001	2080150001	2081150001
20H6160001	20H7160001	2080160001	2081160001
20H6170001	20H7170001	2080170001	2081170001

N.B./P.N.: LUNGHEZZA MASSIMA VERSIONE CROMO = 2,00 m / MAXIMUM LENGTH CHROME VERSION = 2.00 m
TESTATE DI CHIUSURA NON INCLUSE / DEAD ENDS NOT INCLUDED



TESTATE DI CHIUSURA / DEAD ENDS



FINITURA STRUTTURA FINISHES	CODICE CODE	FINITURA STRUTTURA FINISHES	CODICE CODE
GRIGIO VESUVIO ANTHRACITE	200400	GRIGIO AVIO GREY AVIO	200411
ARGILLA CLAY	200401	ARGENTO COMETA/SILVER COMET	200412
BIANCO INTONACO/WHITE	200403	OTTONE VENEZIANO BRASS	200413
NERO CARAVAGGIO BLACK	200404	TITANIO/TITANIUM	200414
MOKA MOCHA	200405	BRONZO RIACI/RIACI BRONZE	200415
CROMO/CHROME	200408	VERDE COSTA/GREEN COAST	200416
ORO CALIFORNIA/GOLD	200409	TERRA SENESE SENESE EARTH	200417
ARAMEN COPPER	200410		

Nel codice sono comprese le viti per il fissaggio delle testate al profilo. Il codice contiene n° 1 testate di chiusura. / The code includes the screws for fixing the heads to the profile. The code contains 1 closing warheads

GIUNTI / JOINTS

DESCRIZIONE DESCRIPTION	FINITURA FINISHES	CODICE CODE
GIUNTO LINEA CONTINUA / STRAIGHT JOINT Accessorio per giunzioni meccaniche lineari Accessory for linear mechanical joints	ALLUMINIO NATURALE/ALUMINUM	200606
GIUNTO 90° ORIZZONTALE / HORIZONTAL JOINT 90° Accessorio per giunzioni meccaniche con angolo 90° Accessory for linear mechanical joints with 90° angle	ALLUMINIO NATURALE/ALUMINUM	200502

Nel codice sono compresi i grani per il fissaggio del giunto
The code includes the grains for fixing the joint.

ATTACCO A PLAFONE / CEILING MOUNT

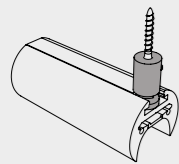

FINITURA STRUTTURA FINISHES	CODICE CODE	FINITURA STRUTTURA FINISHES	CODICE CODE
GRIGIO VESUVIO ANTHRACITE	200500	GRIGIO AVIO GREY AVIO	200512
ARGILLA CLAY	200501	ARGENTO COMETA/SILVER COMET	200512
BIANCO INTONACO/WHITE	200503	OTTONE VENEZIANO BRASS	200513
NERO CARAVAGGIO BLACK	200504	TITANIO/TITANIUM	200414
MOKA MOCHA	200505	BRONZO RIACI/RIACI BRONZE	200415
CROMO/CHROME	200508	VERDE COSTA/GREEN COAST	200416
ORO CALIFORNIA/GOLD	200509	TERRA SENESE SENESE EARTH	200517
ARAMEN COPPER	200510		

Nel codice sono comprese le viti per il fissaggio delle testate al profilo. Il codice contiene n° 1 testate di chiusura. / The code includes the screws for fixing the heads to the profile. The code contains 1 closing warheads

KIT DI SOSPENSIONE / SUSPENSION KIT

ARTICOLI INCLUSI NEL CODICE
ARTICLES INCLUDED IN THE CODE

Cavo in acciaio 2,00m con puntalino
2.00m steel cable with tip
Boccola cromata con regolazione millimetrica
Chrome bush with millimeter adjustment
Sistema di aggancio a profilo
Profile hooking system

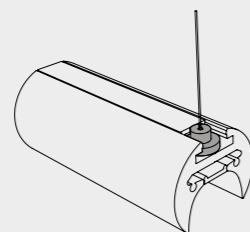

FINITURA FINISHES	CODICE CODE
ALLUMINIO NATURALE/ALUMINUM	200706



LAVORAZIONI / PROCESSING

DATI TECNICI TECHNICAL DATA	CODICE CODE
TAGLIO 90° ORIZZONTALE (PER ANGOLI FORMATI DA DUE PROFILI) HORIZONTAL 90 ° CUT (FOR CORNERS MADE OF TWO PROFILES)	190X
ASOLA / SLOT	100A
ASOLA CUSTOM / SLOT CUSTOM	100N
FORO / HOLE	100F

“a più alta efficienza energetica”

La nuova famiglia K è il risultato di lavoro duro, dedizione, talento, entusiasmo e passione che ogni persona nella nostra azienda ha messo in questo straordinario progetto, permettendoci di presentare a tutta la nostra clientela nazionale ed internazionale profili evoluti. Design Luce è stata la prima azienda italiana a proporre una gamma con elevate prestazioni, personalità, bellezza e qualità tipiche del made in Italy. K25 è stato pensato per integrare al suo interno elementi ottici, consentendoci di ottenere basse luminanze e impiegare al meglio sorgenti luminose a led di ultima generazione con elevati CRI fino a 95 e con la più alta efficienza energetica (fino a 150lm/W).

La gamma di finiture, la personalizzazione del progetto, caratteristica ormai consolidate della nostra azienda, rendono questa famiglia uno strumento indispensabile per il progettista.

The new range of “K” products is the outcome of hard work, dedication, talent, enthusiasm and passion that the staff of Design Luce dedicated to this extraordinary project. Design Luce is now the first Italian company able to offer advanced aluminum lighting profiles with high performance, personality, beauty and quality typical of Made in Italy.

K25 is designed to integrate excellent optical and thermal elements to allowing to use at the best the performance of the last generations of LED light sources with CRI up to 95 and the highest energy efficiency (up to 150 lm/W). The range of finishes, the customization of the project, a well-established feature of our company, make this family an indispensable tool for designers and architects.



k25

k25

configurazioni

configurations

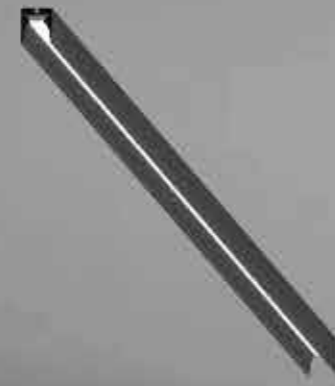

È POSSIBILE RICHIEDERE LA REALIZZAZIONE DI COMPOSIZIONI ANGOLARI CON ANGOLO DI AMPIEZZA DIVERSA DA 90°.
OGNI RICHIESTA DEVE PERVENIRE AL NOSTRO UFFICIO TECNICO CORREDATA DA PROGETTO.
IT IS POSSIBLE TO REQUEST THE CREATION OF ANGULAR COMPOSITIONS WITH AN ANGLE OF DIFFERENT 90°.
EVERY REQUEST MUST COME TO OUR TECHNICAL OFFICE WITH PROJECT.

LE CONFIGURAZIONI SOPRA RIPORTATE SONO COMPATIBILI PER LA VERSIONE CON DIFFUSORE RECESSO E PER LA VERSIONE CON DIFFUSORE ESTERNO.
THE CONFIGURATIONS SHOWN ABOVE ARE COMPATIBLE FOR THE VERSION WITH RECESSED DIFFUSER AND FOR THE VERSION WITH EXTERNAL SPEAKER.

INSTALLAZIONE A SOSPENSIONE
SUSPENSION

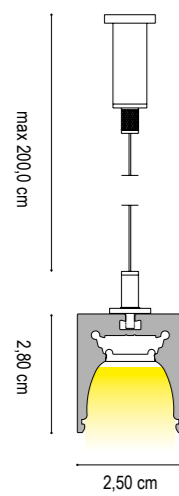

INSTALLAZIONE CON CLIP IN POLICARBONATO SU SUPERFICIE ORIZZONTALE
INSTALLATION WITH POLYCARBONATE CLIP ON HORIZONTAL SURFACE

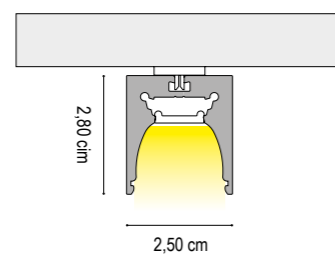

INSTALLAZIONE CON CLIP IN POLICARBONATO SU SUPERFICIE VERTICALE
INSTALLATION WITH POLYCARBONATE CLIP ON A VERTICAL SURFACE

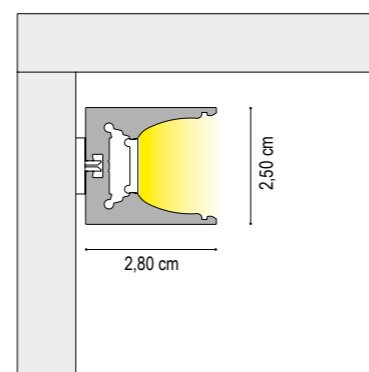

INSTALLAZIONE CON STAFFA MAGNETICA SU SUPERFICIE METALLICA ORIZZONTALE
INSTALLATION WITH MAGNET ON HORIZONTAL METAL SURFACE

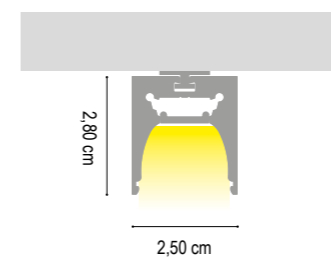

SI RACCOMANDA L'UTILIZZO DI N° 1 STAFFA MAGNETICA OGNI 25,00 cm DI PROFILO. TALE QUANTITÀ PUÒ VARIARE A SECONDA DELLA SUPERFICIE METALLICA DI INSTALLAZIONE.

WE RECOMMEND THE USE OF N° 1 MAGNETIC BRACKET EVERY 25.00 cm OF PROFILE. THIS QUANTITY MAY VARY DEPENDING ON THE METAL INSTALLATION SURFACE.

INSTALLAZIONE A PARETE
WALL INSTALLATION

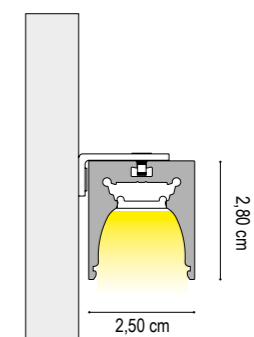

k25

led integrato

integrated led

DATI TECNICI
TECHNICAL DATA

DIFFUSORE RECESSO / RECESSED DIFFUSER

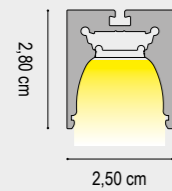

	1 cm - 20W/m	1 cm - 24W/m
Nominal LED Flux:	2200 lm/m	2160 lm/m
Flux Tot:	1760 lm/m	1728 lm/m
Output:	110 lm/W	90 lm/W
CCT:	3000 K	3000 K
CRI:	>90	>90
Power Tot:	20.0W/m	24.0W/m
Weight:	0.30 Kg/m	0.30 Kg/m

Profilo/Profile: Alluminio/aluminum

Cover: Opale/opal

Lmax = 300 cm

DRIVER NON INCLUSO / NOT INCLUDED

CAVO ALIMENTAZIONE: 50 cm
ALIMENTATION CABLE: 50 cm

1 cm - 20W/m

1 cm - 24W/m

FINITURA STRUTTURA FINISHES	DIFFUSORE DIFFUSER	1 cm - 20W/m		1 cm - 24W/m	
		CODICE 2700K CODE 2700K	CODICE 3000K CODE 3000K	CODICE 2700K CODE 2700K	CODICE 3000K CODE 3000K
GRIGIO VESUVIO ANTHRACITE		2546000001	2547000001	25H6000001	25H7000001
ARGILLA CLAY		2546010001	2547010001	25H6010001	25H7010001
BIANCO INTONACO/WHITE		2546030001	2547030001	25H6030001	25H7030001
NERO CARAVAGGIO BLACK		2546040001	2547040001	25H6040001	25H7040001
MOKA MOCHA		2546050001	2547050001	25H6050001	25H7050001
CROMO CHROME		2546080001	2547080001	25H6080001	25H7080001
ORO CALIFORNIA/GOLD	SATINATA/SATIN	2546090001	2547090001	25H6090001	25H7090001
ARAMEN COPPER	OPALE/OPAL	2546100001	2547100001	25H6100001	25H7100001
GRIGIO AVIO/GREY AVIO		2546110001	2547110001	25H6110001	25H7110001
OTTONE VENEZIANO/VENETIAN BRASS		2546130001	2547130001	25H6130001	25H7130001
TITANIO/TITANIUM		2546140001	2547140001	25H6140001	25H7140001
BRONZO RIACI/RIACI BRONZE		2546150001	2547150001	25H6150001	25H7150001
VERDE COSTA/GREEN COAST		2546160001	2547160001	25H6160001	25H7160001
TERRA SENESE SENESE EARTH		2546170001	2547170001	25H6170001	25H7170001

N.B./P.N.: LUNGHEZZA MASSIMA VERSIONE CROMO = 2,00 m / MAXIMUM LENGTH CHROME VERSION = 2.00 m
TESTATE DI CHIUSURA NON INCLUSE / DEAD ENDS NOT INCLUDED

k25

led integrato

integrated led

DATI TECNICI
TECHNICAL DATA

DIFFUSORE ESTERNO / EXTERNAL DIFFUSER

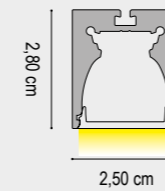

	1 cm - 20W/m	1 cm - 24W/m
Nominal LED Flux:	2200 lm/m	2160 lm/m
Flux Tot:	1760 lm/m	1728 lm/m
Output:	110 lm/W	90 lm/W
CCT:	3000 K	3000 K
CRI:	>90	>90
Power Tot:	20.0W/m	24.0W/m
Weight:	0.30 Kg/m	0.30 Kg/m

Profilo/Profile: Alluminio/aluminum

Cover: Opale/opal

Lmax = 300 cm

DRIVER NON INCLUSO / NOT INCLUDED

CAVO ALIMENTAZIONE: 50 cm
ALIMENTATION CABLE: 50 cm

1 cm - 20W/m

1 cm - 23W/m

FINITURA STRUTTURA FINISHES	DIFFUSORE DIFFUSER	1 cm - 20W/m		1 cm - 23W/m	
		CODICE 2700K CODE 2700K	CODICE 3000K CODE 3000K	CODICE 2700K CODE 2700K	CODICE 3000K CODE 3000K
GRIGIO VESUVIO ANTHRACITE		2546001001	2547001001	25H6001001	25H7001001
ARGILLA CLAY		2546011001	2547011001	25H6011001	25H7011001
BIANCO INTONACO/WHITE		2546031001	2547031001	25H6031001	25H7031001
NERO CARAVAGGIO BLACK		2546041001	2547041001	25H6041001	25H7041001
MOKA MOCHA		2546051001	2547051001	25H6051001	25H7051001
CROMO CHROME		2546081001	2547081001	25H6081001	25H7081001
ORO CALIFORNIA/GOLD	SATINATA/SATIN	2546091001	2547091001	25H6091001	25H7091001
ARAMEN COPPER	OPALE/OPAL	2546101001	2547101001	25H6101001	25H7101001
GRIGIO AVIO/GREY AVIO		2546111001	2547111001	25H6111001	25H7111001
OTTONE VENEZIANO/VENETIAN BRASS		2546131001	2547131001	25H6131001	25H7131001
TITANIO/TITANIUM		2546141001	2547141001	25H6141001	25H7141001
BRONZO RIACI/RIACI BRONZE		2546151001	2547151001	25H6151001	25H7151001
VERDE COSTA/GREEN COAST		2546161001	2547161001	25H6161001	25H7161001
TERRA SENESE SENESE EARTH		2546171001	2547171001	25H6171001	25H7171001

N.B./P.N.: LUNGHEZZA MASSIMA VERSIONE CROMO = 2,00 m / MAXIMUM LENGTH CHROME VERSION = 2.00 m
TESTATE DI CHIUSURA NON INCLUSE / DEAD ENDS NOT INCLUDED

TESTATE DI CHIUSURA / DEAD ENDS

FINITURA STRUTTURA FINISHES	CODICE CODE	FINITURA STRUTTURA FINISHES	CODICE CODE
GRIGIO VESUVIO ANTHRACITE	250400	GRIGIO AVIO/GREY AVIO	250411
ARGILLA CLAY	250401	ARGENTO COMETA/SILVER COMET	250412
BIANCO INTONACO/WHITE	250403	OTTONE VENEZIANO BRASS	250413
NERO CARAVAGGIO BLACK	250404	TITANIO/TITANIUM	250414
MOKA MOCHA	250405	BRONZO RIACI/RIACI BRONZE	250415
CROMO/CHROME	250408	VERDE COSTA/GREEN COAST	250416
ORO CALIFORNIA/GOLD	250409	TERRA SENESE SENESE EARTH	250417
ARAMEN COPPER	250410		

Nel codice sono comprese le viti per il fissaggio delle testate al profilo. Il codice contiene n° 1 testate di chiusura. / The code includes the screws for fixing the heads to the profile. The code contains 1 closing warheads

STAFFA DI FISSAGGIO / MOUNTING CLIP

FINITURA FINISHES	CODICE CODE	PORTATA RANGE
SUPERFICI PIANE 2mm EVEN SURFACE 2mm	102050003	1 Kg
SUPERFICI IRREGOLARI 3,5mm UNEVEN SURFACE 3,5mm	102050004	2 Kg

Accessorio per fissaggio a plafone/superficie. Quantità raccomandata: 1 pz ogni 50 cm di profilo
Ceiling/surface mounting accessory. Recommended quantity: 1 pc every 50 cm of profile

CALAMITA / MAGNET

CODICE CODE	PORTATA RANGE
102050001	1 Kg
1020500210	2 Kg

Quantità raccomandata: 1 pz ogni 25cm di profilo
Recommended quantity: 1 pc every 25cm of profile

GIUNTI / JOINTS

GIUNTO	FINITURA FINISHES	CODICE CODE
GIUNTO LINEA CONTINUA / STRAIGHT JOINT Accessorio per giunzioni meccaniche lineari Accessory for linear mechanical joints	ALLUMINIO NATURALE/ALUMINUM	101050006
GIUNTO 90° ORIZZONTALE / HORIZONTAL JOINT 90° Accessorio per giunzioni meccaniche con angolo 90° Accessory for linear mechanical joints with 90° angle	ALLUMINIO NATURALE/ALUMINUM	101050005
GIUNTO 90° VERTICALE / VERTICAL JOINT 90° Accessorio per giunzioni meccaniche con angolo 90° Accessory for linear mechanical joints with 90° angle	ALLUMINIO NATURALE/ALUMINUM	101050007

Nel codice sono compresi i grani per il fissaggio del giunto
The code includes the grains for fixing the joint.

STAFFA DI FISSAGGIO A PARETE / WALL MOUNTING CLIP

DATI TECNICI TECHNICAL DATA	FINITURA STRUTTURA FINISHES	CODICE CODE
MATERIALE: Alluminio naturale MATERIAL: Natural aluminum	GRIGIO VESUVIO ANTHRACITE	103050003
	ARGILLA CLAY	1030501003
	BIANCO INTONACO/WHITE	1030503003
	NERO CARAVAGGIO BLACK	1030504003
	MOKA MOCHA	1030505003
	CROMO/CHROME	1030508003
	ORO CALIFORNIA/GOLD	1030509003
	ARAMEN COPPER	1030510003
	ARGENTO COMETA/SILVER COMET	1030512003
	OTTONE VENEZIANO VENETIAN BRASS	1030513003
	TITANIO/TITANIUM	1030514003
	BRONZO RIACI/RIACI BRONZE	1030515003
	VERDE COSTA/GREEN COAST	1030516003
	TERRA SENESE SENESE EARTH	1030517003

KIT DI SOSPENSIONE / SUSPENSION KIT

DATI TECNICI TECHNICAL DATA	FINITURA STRUTTURA FINISHES	CODICE CODE
ARTICOLI INCLUSI NEL CODICE ARTICLES INCLUDED IN THE CODE	GRIGIO VESUVIO ANTHRACITE	104050004
	ARGILLA CLAY	1040501004
	BIANCO INTONACO/WHITE	1040503004
	NERO CARAVAGGIO BLACK	1040504004
	MOKA MOCHA	1040505004
	CROMO/CHROME	1040508004
	ORO CALIFORNIA/GOLD	1040509004
	ARAMEN COPPER	1040510004
	ARGENTO COMETA/SILVER COMET	1040512004
	OTTONE VENEZIANO VENETIAN BRASS	1040513004
	TITANIO/TITANIUM	1040514004
	BRONZO RIACI/RIACI BRONZE	1040515004
	VERDE COSTA/GREEN COAST	1040516004
	TERRA SENESE SENESE EARTH	1040517004

LAVORAZIONI / PROCESSING

DATI TECNICI TECHNICAL DATA	CODICE CODE
TAGLIO 90° ORIZZONTALE (PER ANGOLI FORMATI DA DUE PROFILI) HORIZONTAL 90° CUT (FOR CORNERS MADE OF TWO PROFILES)	190X
TAGLIO 90° VERTICALE (PER ANGOLI FORMATI DA DUE PROFILI) VERTICAL 90° CUT (FOR CORNERS MADE OF TWO PROFILES)	190Y
TAGLIO ANGOLARE CUSTOM (PER ANGOLI FORMATI DA DUE PROFILI) CUSTOM CORNER CUT (FOR CORNERS MADE OF TWO PROFILES)	190N
ASOLA / SLOT	100A
ASOLA CUSTOM / SLOT CUSTOM	100N
FORO / HOLE	100F

“fascio di luce diretto e concentrato”

K15 è il profilo più piccolo della famiglia K di Design Luce. Coniuga in un design unico e minimale tutta la nostra esperienza nel settore delle ottiche e dell'illuminazione con sorgenti LED.

È realizzato in alluminio estruso e verniciato nelle finiture proposte. Genera un fascio di luce diretto e concentrato grazie alla posizione arretrata delle ottiche.

K15 is the smallest profile in the K family of Design Luce. It combines in a unique and minimal design all our experience in the field of optics and lighting with LED sources. It is made of extruded aluminum and painted in the proposed finishes. It generates a direct and concentrated light beam thanks to the rearward position of the optics.



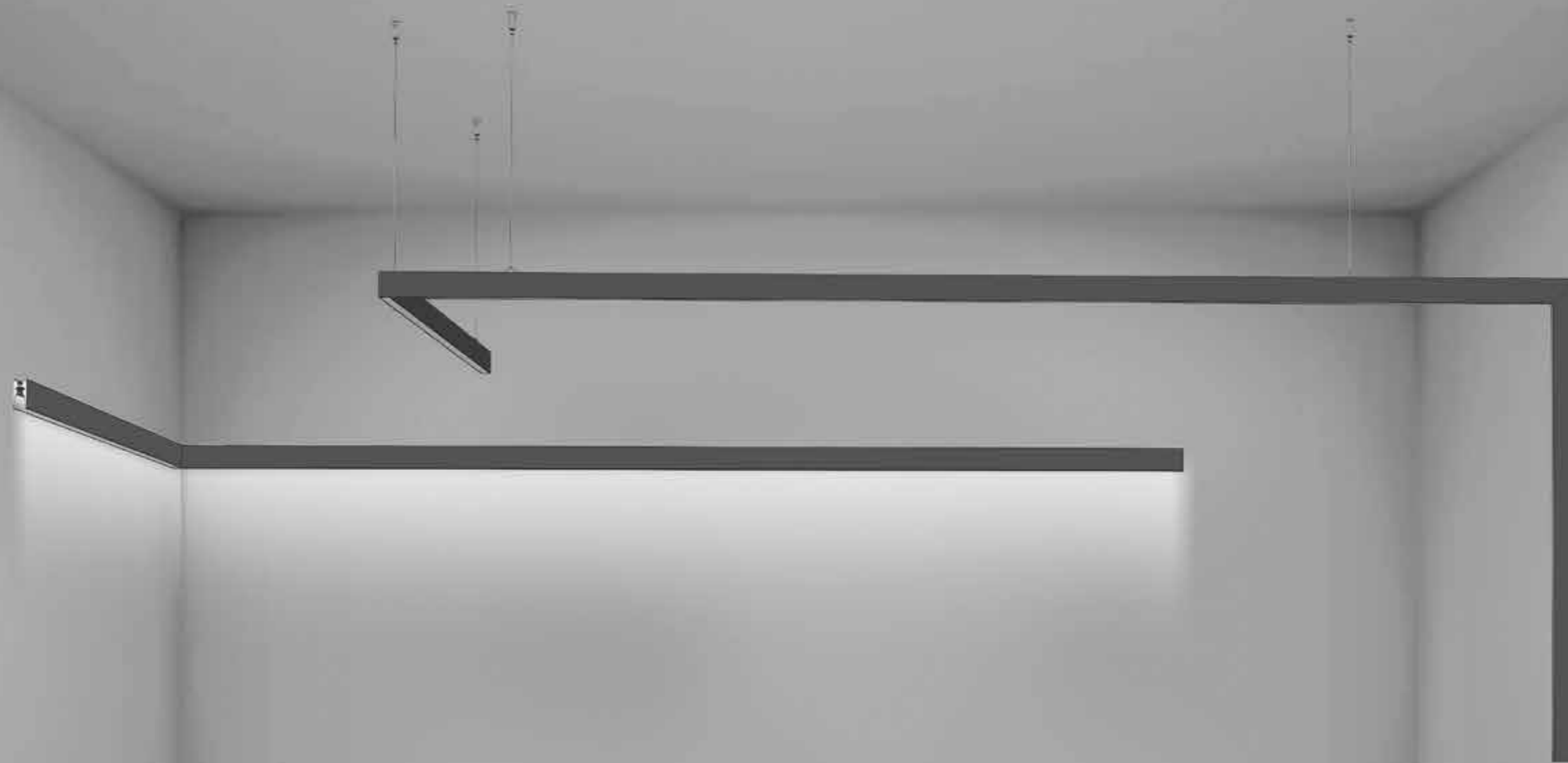

È POSSIBILE RICHIEDERE LA REALIZZAZIONE DI COMPOSIZIONI ANGOLARI CON ANGOLO DI AMPIEZZA DIVERSA DA 90°.
OGNI RICHIESTA DEVE PERVENIRE AL NOSTRO UFFICIO TECNICO CORREDATA DA PROGETTO.

IT IS POSSIBLE TO REQUEST THE CREATION OF ANGULAR COMPOSITIONS WITH AN ANGLE OF DIFFERENT 90 °.
EVERY REQUEST MUST COME TO OUR TECHNICAL OFFICE WITH PROJECT.

LE CONFIGURAZIONI SOPRA RIPORTATE SONO COMPATIBILI PER LA VERSIONE CON DIFFUSORE RECESSO E PER LA VERSIONE CON DIFFUSORE ESTERNO.
THE CONFIGURATIONS SHOWN ABOVE ARE COMPATIBLE FOR THE VERSION WITH RECESSED DIFFUSER AND FOR THE VERSION WITH EXTERNAL SPEAKER.

INSTALLAZIONE A SOSPENSIONE
SUSPENSION

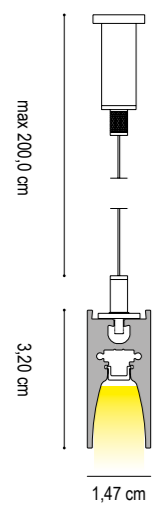

INSTALLAZIONE CON CLIP IN POLICARBONATO SU SUPERFICIE ORIZZONTALE
INSTALLATION WITH POLYCARBONATE CLIP ON HORIZONTAL SURFACE

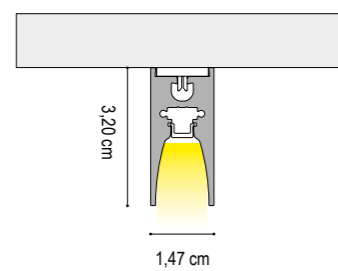

INSTALLAZIONE CON CLIP IN POLICARBONATO SU SUPERFICIE VERTICALE
INSTALLATION WITH POLYCARBONATE CLIP ON A VERTICAL SURFACE

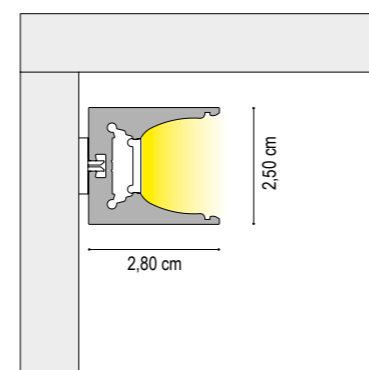

INSTALLAZIONE CON STAFFA MAGNETICA SU SUPERFICIE METALLICA ORIZZONTALE
INSTALLATION WITH MAGNET ON HORIZONTAL METAL SURFACE

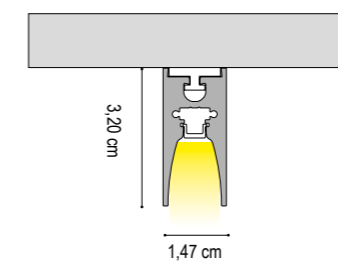

SI RACCOMANDA L'UTILIZZO DI N° 1 STAFFA MAGNETICA OGNI 25,00 cm DI PROFILO. TALE QUANTITÀ PUÒ VARIARE A SECONDA DELLA SUPERFICIE METALLICA DI INSTALLAZIONE.

WE RECOMMEND THE USE OF N° 1 MAGNETIC BRACKET EVERY 25,00 cm OF PROFILE. THIS QUANTITY MAY VARY DEPENDING ON THE METAL INSTALLATION SURFACE.

INSTALLAZIONE A PARETE
WALL INSTALLATION

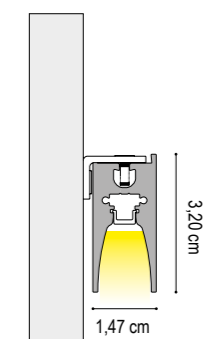

DATI TECNICI
TECHNICAL DATA

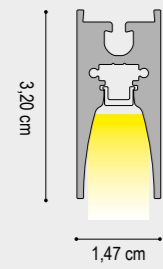

	1 cm - 12W/m	1 cm - 14,4W/m
Nominal LED Flux:	1900 lm/m	1200 lm/m
Flux Tot:	1520 lm/m	960 lm/m
Output:	158 lm/W	85 lm/W
CCT:	3000 K	3000 K
CRI:	>90	>90
Power Tot:	12.0W/m	14.4W/m
Weight:	0.20 Kg/m	0.20 Kg/m

Profilo/Profile: Alluminio/aluminum

Cover: Opale/opal

Lmax = 300 cm

DRIVER NON INCLUSO / NOT INCLUDED

CAVO ALIMENTAZIONE: 50 cm
ALIMENTATION CABLE: 50 cm

DATI TECNICI
TECHNICAL DATA

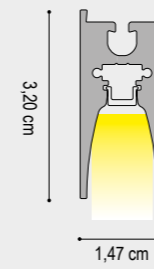

	1 cm - 12W/m
Nominal LED Flux:	1610 lm/m
Flux Tot:	1288 lm/m
Output:	138 lm/W
CCT:	3000 K
CRI:	>97 - R9>90
Power Tot:	12.0W/m
Weight:	0.20 Kg/m

Profilo/Profile: Alluminio/aluminum

Cover: Opale/opal

Lmax = 300 cm

DRIVER NON INCLUSO / NOT INCLUDED

CAVO ALIMENTAZIONE: 50 cm
ALIMENTATION CABLE: 50 cm

1 cm - 12W/m

1 cm - 12W/m

FINITURA STRUTTURA
FINISHES

- GRIGIO VESUVIO ANTHRACITE
- ARGILLA CLAY
- ARGENTO OPACO/MATT SILVER
- BIANCO INTONACO/WHITE
- NERO CARAVAGGIO BLACK
- MOKA MOCHA
- CROMO CHROME
- ORO CALIFORNIA GOLD
- ARAMEN COPPER
- ARGENTO COMETA/SILVER COMET
- OTTONE VENEZIANO VENETIAN BRASS
- TITANIO/TITANIUM
- BRONZO RIACI/RIACI BRONZE
- VERDE COSTA/GREEN COAST
- TERRA SENESE SENESE EARTH

DIFFUSORE
DIFFUSER

- OPALE/OPAL

	CODICE 2700K CODE 2700K	CODICE 3000K CODE 3000K	CODICE 4000K CODE 4000K
GRIGIO VESUVIO ANTHRACITE	1554000001	1555000001	1556000001
ARGILLA CLAY	1554010001	1555010001	1556010001
ARGENTO OPACO/MATT SILVER	1554020001	1555020001	1556020001
BIANCO INTONACO/WHITE	1554030001	1555030001	1556030001
NERO CARAVAGGIO BLACK	1554040001	1555040001	1556040001
MOKA MOCHA	1554050001	1555050001	1556050001
CROMO CHROME	1554080001	1555080001	1556080001
ORO CALIFORNIA GOLD	1554090001	1555090001	1556090001
ARAMEN COPPER	1554100001	1555100001	1556100001
ARGENTO COMETA/SILVER COMET	1554120001	1555120001	1556120001
OTTONE VENEZIANO VENETIAN BRASS	1554130001	1555130001	1556130001
TITANIO/TITANIUM	1554140001	1555140001	1556140001
BRONZO RIACI/RIACI BRONZE	1554150001	1555150001	1556150001
VERDE COSTA/GREEN COAST	1554160001	1555160001	1556160001
TERRA SENESE SENESE EARTH	1554170001	1555170001	1556170001

FINITURA STRUTTURA
FINISHES

- GRIGIO VESUVIO ANTHRACITE
- ARGILLA CLAY
- ARGENTO OPACO/MATT SILVER
- BIANCO INTONACO/WHITE
- NERO CARAVAGGIO BLACK
- MOKA MOCHA
- CROMO CHROME
- ORO CALIFORNIA GOLD
- ARAMEN COPPER
- ARGENTO COMETA/SILVER COMET
- OTTONE VENEZIANO VENETIAN BRASS
- TITANIO/TITANIUM
- BRONZO RIACI/RIACI BRONZE
- VERDE COSTA/GREEN COAST
- TERRA SENESE SENESE EARTH

DIFFUSORE
DIFFUSER

- OPALE/OPAL

	CODICE 2700K CODE 2700K	CODICE 3000K CODE 3000K	CODICE 4000K CODE 4000K
GRIGIO VESUVIO ANTHRACITE	1596000001	1597000001	1598000001
ARGILLA CLAY	1596010001	1597010001	1598010001
ARGENTO OPACO/MATT SILVER	1596020001	1597020001	1598020001
BIANCO INTONACO/WHITE	1596030001	1597030001	1598030001
NERO CARAVAGGIO BLACK	1596040001	1597040001	1598040001
MOKA MOCHA	1596050001	1597050001	1598050001
CROMO CHROME	1596080001	1597080001	1598080001
ORO CALIFORNIA GOLD	1596090001	1597090001	1598090001
ARAMEN COPPER	1596100001	1597100001	1598100001
ARGENTO COMETA/SILVER COMET	1596120001	1597120001	1598120001
OTTONE VENEZIANO VENETIAN BRASS	1596130001	1597130001	1598130001
TITANIO/TITANIUM	1596140001	1597140001	1598140001
BRONZO RIACI/RIACI BRONZE	1596150001	1597150001	1598150001
VERDE COSTA/GREEN COAST	1596160001	1597160001	1598160001
TERRA SENESE SENESE EARTH	1596170001	1597170001	1598170001

N.B./P.N.: LUNGHEZZA MASSIMA VERSIONE CROMO = 2,00 m / MAXIMUM LENGTH CHROME VERSION = 2.00 m
TESTATE DI CHIUSURA NON INCLUSE / DEAD ENDS NOT INCLUDED

N.B./P.N.: LUNGHEZZA MASSIMA VERSIONE CROMO = 2,00 m / MAXIMUM LENGTH CHROME VERSION = 2.00 m
TESTATE DI CHIUSURA NON INCLUSE / DEAD ENDS NOT INCLUDED

TESTATE DI CHIUSURA / DEAD ENDS

FINITURA STRUTTURA FINISHES	CODICE CODE	FINITURA STRUTTURA FINISHES	CODICE CODE
GRIGIO VESUVIO ANTHRACITE	150400	ARAMEN COPPER	150410
ARGILLA CLAY	150401	ARGENTO COMETA/SILVER COMET	150412
ARGENTO OPACO MATT SILVER	150402	OTTONE VENEZIANO/BRASS	150413
BIANCO INTONACO/WHITE	150403	TITANIO/TITANIUM	150414
NERO CARAVAGGIO BLACK	150404	BRONZO RIACI/RIACI BRONZE	150415
MOKA MOCHA	150405	VERDE COSTA/GREEN COAST	150416
CROMO/CHROME	150408	TERRA SENESE SENESE EARTH	150417
ORO CALIFORNIA/GOLD	150409		

Nel codice sono comprese le viti per il fissaggio delle testate al profilo. Il codice contiene n° 1 testate di chiusura. / The code includes the screws for fixing the heads to the profile. The code contains 1 closing warheads

STAFFA DI FISSAGGIO / MOUNTING CLIP

FINITURA FINISHES	CODICE CODE
SUPERFICI PIANE 2mm EVEN SURFACE 2mm	102050003
SUPERFICI IRREGOLARI 3,5mm UNEVEN SURFACE 3,5mm	102050004

Accessorio per fissaggio a plafone/superficie. Quantità raccomandata: 1 pz ogni 50 cm di profilo
Ceiling/surface mounting accessory. Recommended quantity: 1 pc every 50 cm of profile

CALAMITA / MAGNET

CODICE CODE	PORTATA RANGE
102050001	1 Kg
1020500210	2 Kg

Quantità raccomandata: 1 pz ogni 25cm di profilo
Recommended quantity: 1 pc every 25cm of profile

GIUNTI / JOINTS

	FINITURA FINISHES	CODICE CODE
GIUNTO LINEA CONTINUA / STRAIGHT JOINT Accessorio per giunzioni meccaniche lineari Accessory for linear mechanical joints	ALLUMINIO NATURALE/ALUMINUM	1010500006
GIUNTO 90° ORIZZONTALE / HORIZONTAL JOINT 90° Accessorio per giunzioni meccaniche con angolo 90° Accessory for linear mechanical joints with 90° angle	ALLUMINIO NATURALE/ALUMINUM	1010500005
GIUNTO 90° VERTICALE / VERTICAL JOINT 90° Accessorio per giunzioni meccaniche con angolo 90° Accessory for linear mechanical joints with 90° angle	ALLUMINIO NATURALE/ALUMINUM	1010500007

Nel codice sono compresi i grani per il fissaggio del giunto
The code includes the grains for fixing the joint.

STAFFA DI FISSAGGIO A PARETE / WALL MOUNTING CLIP

DATI TECNICI TECHNICAL DATA	FINITURA STRUTTURA FINISHES	CODICE CODE
MATERIALE: Alluminio naturale MATERIAL: Natural aluminum Il codice comprende n°2 staffe con asole. The code includes n°2 wall brackets with holes.	ALLUMINIO NATURALE/ALUMINUM	150506A

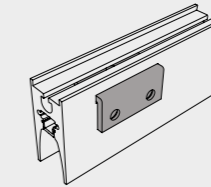

KIT DI SOSPENSIONE / SUSPENSION KIT

DATI TECNICI TECHNICAL DATA	FINITURA STRUTTURA FINISHES	CODICE CODE
ARTICOLI INCLUSI NEL CODICE ARTICLES INCLUDED IN THE CODE Cavo in acciaio 2,00m con puntalino 2.00m steel cable with tip Boccola cromata con regolazione millimetrica Chrome bush with millimeter adjustment Archetto in alluminio per sospensione Aluminum arch for suspension	GRIGIO VESUVIO ANTHRACITE ARGILLA CLAY BIANCO INTONACO/WHITE NERO CARAVAGGIO BLACK MOKA MOCHA CROMO/CHROME ORO CALIFORNIA/GOLD ARAMEN COPPER ARGENTO COMETA/SILVER COMET OTTONE VENEZIANO/VENETIAN BRASS TITANIO/TITANIUM BRONZO RIACI/RIACI BRONZE VERDE COSTA/GREEN COAST TERRA SENESE SENESE EARTH	1040500004 1040501004 1040503004 1040504004 1040505004 1040508004 1040509004 1040510004 1040512004 1040513004 1040514004 1040515004 1040516004 1040517004

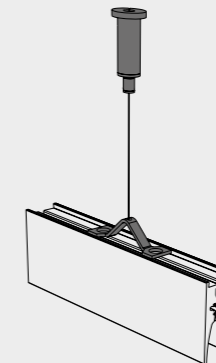

LAVORAZIONI / PROCESSING

DATI TECNICI TECHNICAL DATA	CODICE CODE
TAGLIO 90° ORIZZONTALE (PER ANGOLI FORMATI DA DUE PROFILI) HORIZONTAL 90° CUT (FOR CORNERS MADE OF TWO PROFILES)	190X
TAGLIO 90° VERTICALE (PER ANGOLI FORMATI DA DUE PROFILI) VERTICAL 90° CUT (FOR CORNERS MADE OF TWO PROFILES)	190Y
TAGLIO ANGOLARE CUSTOM (PER ANGOLI FORMATI DA DUE PROFILI) CUSTOM CORNER CUT (FOR CORNERS MADE OF TWO PROFILES)	190N
ASOLA / SLOT	100A
ASOLA CUSTOM/ SLOT CUSTOM	100N
FORO / HOLE	100F

“forma tonda”

S21 la sua forma tonda è sicuramente un elemento che lo contraddistingue, le due semisfere costruite in materiale policarbonato ed alluminio, equipaggiato con sorgenti luminose a led fino al Cri > 97 con angoli d' apertura di 120° lo rendono estremamente elegante e funzionale. Viene fornito in due versioni Sospensioni e Soffitto e in diverse finiture.

S21 its round shape is definitely an element that distinguishes it, the two hemispheres built in polycarbonate and aluminum material, equipped with LED light sources up to Cri > 97 with 120 ° opening angles make it extremely elegant and functional. It is supplied in two versions Suspensions and Ceiling and in different finishes.





INSTALLAZIONE A SOSPENSIONE
SUSPENSION

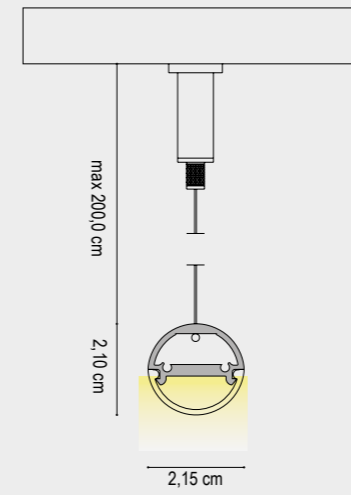

INSTALLAZIONE A SOFFITTO
CEILING INSTALLATION

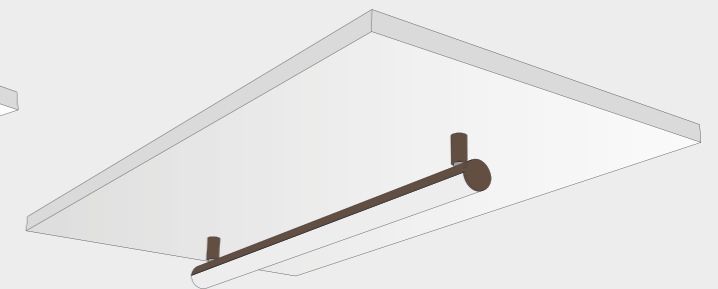
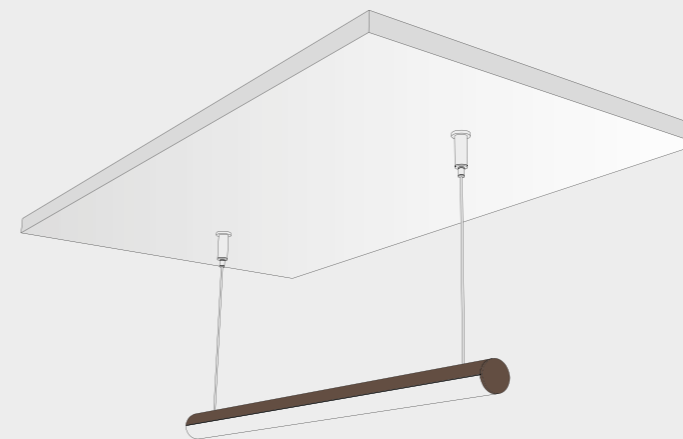
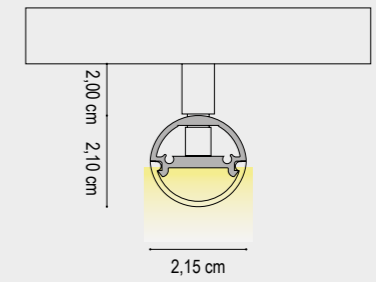

INSTALLAZIONE A SOSPENSIONE
SUSPENSION INSTALLATION

ACCESSORI INCLUSI
ACCESSORIES INCLUDED

KIT DI SOSPENSIONE / SUSPENSION KIT

INSTALLAZIONE A SOFFITTO
CEILING INSTALLATION

ACCESSORI INCLUSI
ACCESSORIES INCLUDED

KIT DI FISSAGGIO A SOFFITTO / CEILING FIXING KIT

s21 — sospensione / suspension

led integrato

integrated led

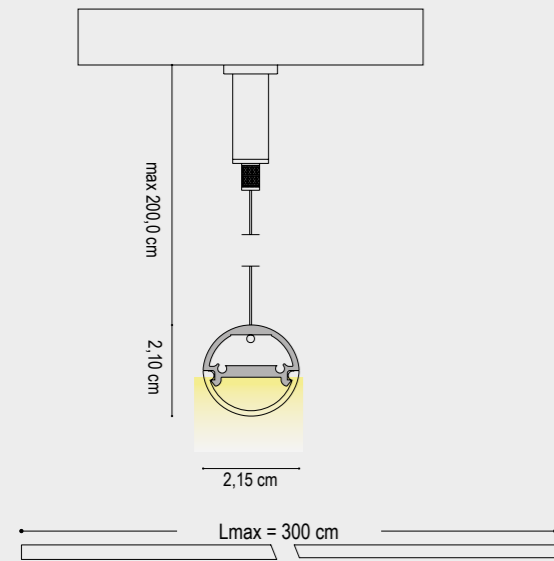

DATI TECNICI
TECHNICAL DATA

1 cm - 19,2W/m	
Nominal LED Flux:	2100 lm/m
Flux Tot:	1680 lm/m
Output:	110 lm/W
CCT:	3000 K
CRI:	>95
Power Tot:	19,2W/m
Weight:	0.40 Kg/m

Profilo/Profile: Alluminio/aluminum Cover: Opale/opal

DRIVER NON INCLUSO / NOT INCLUDED CAVO ALIMENTAZIONE: 50 cm
ALIMENTATION CABLE: 50 cm

s21 — soffitto / ceiling

led integrato

integrated led

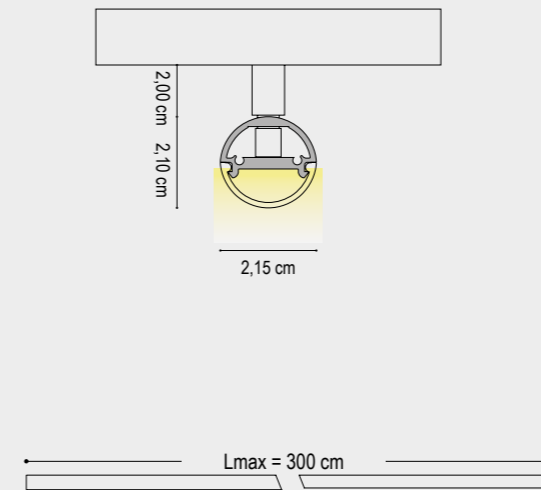

DATI TECNICI
TECHNICAL DATA

1 cm - 19,2W/m	
Nominal LED Flux:	2100 lm/m
Flux Tot:	1680 lm/m
Output:	110 lm/W
CCT:	3000 K
CRI:	>95
Power Tot:	19,2W/m
Weight:	0.40 Kg/m

Profilo/Profile: Alluminio/aluminum Cover: Opale/opal

DRIVER NON INCLUSO / NOT INCLUDED CAVO ALIMENTAZIONE: 50 cm
ALIMENTATION CABLE: 50 cm

FINITURA STRUTTURA
FINISHES

- GRIGIO VESUVIO ANTHRACITE
- ARGILLA CLAY
- BIANCO INTONACO/WHITE
- NERO CARAVAGGIO/BLACK
- MOKA MOCHA
- CROMO/CHROME
- ORO CALIFORNIA/GOLD
- ARAMEN COPPER
- ARGENTO COMETA/SILVER COMET
- OTTONE VENEZIANO/VENETIAN BRASS
- TITANIO/TITANIUM
- BRONZO RIACI/RIACI BRONZE
- VERDE COSTA/GREEN COAST
- TERRA SENESE SENESE EARTH

DIFFUSORE
DIFFUSER

- OPALE/OPAL

1 cm - 20W/m

CODICE 2700K CODE 2700K	CODICE 3000K CODE 3000K	CODICE 4000K CODE 4000K
132500001	132600001	132700001
132501001	132601001	132701001
132503001	132603001	132703001
132504001	132604001	132704001
132505001	132605001	132705001
132508001	132608001	132708001
132509001	132609001	132709001
132510001	132610001	132710001
132512001	132612001	132712001
132513001	132613001	132713001
132514001	132614001	132714001
132515001	132615001	132715001
132516001	132616001	132716001
132517001	132617001	132717001

N.B./P.N.: LUNGHEZZA MASSIMA VERSIONE CROMO = 2,00 m / MAXIMUM LENGTH CHROME VERSION = 2.00 m
TESTATE DI CHIUSURA NON INCLUSE / DEAD ENDS NOT INCLUDED

KIT DI SOSPENSIONE / SUSPENSION KIT

FINITURA STRUTTURA
FINISHES

- CROMO/CHROME

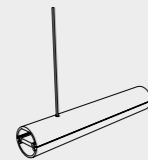

CODICE
CODE

1100508200

N.B./P.N.: PER LUNGHEZZE SUPERIORI A 200CM ORDINARE N°3 KIT / FOR LENGTHS GREATER THAN 200CM ORDER N°3 KIT

FINITURA STRUTTURA
FINISHES

- GRIGIO VESUVIO ANTHRACITE
- ARGILLA CLAY
- BIANCO INTONACO/WHITE
- NERO CARAVAGGIO/BLACK
- MOKA MOCHA
- CROMO/CHROME
- ORO CALIFORNIA/GOLD
- ARAMEN COPPER
- ARGENTO COMETA/SILVER COMET
- OTTONE VENEZIANO/VENETIAN BRASS
- TITANIO/TITANIUM
- BRONZO RIACI/RIACI BRONZE
- VERDE COSTA/GREEN COAST
- TERRA SENESE SENESE EARTH

DIFFUSORE
DIFFUSER

- OPALE/OPAL

CODICE 2700K CODE 2700K	CODICE 3000K CODE 3000K	CODICE 4000K CODE 4000K
132500011	132600011	132700011
132501011	132601011	132701011
132503011	132603011	132703011
132504011	132604011	132704011
132505011	132605011	132705011
132508011	132608011	132708011
132509011	132609011	132709011
132510011	132610011	132710011
132512011	132612011	132712011
132513011	132613011	132713011
132514011	132614011	132714011
132515011	132615011	132715011
132516011	132616011	132716011
132517011	132617011	132717011

N.B./P.N.: LUNGHEZZA MASSIMA VERSIONE CROMO = 2,00 m / MAXIMUM LENGTH CHROME VERSION = 2.00 m
TESTATE DI CHIUSURA NON INCLUSE / DEAD ENDS NOT INCLUDED

ATTACCO A PLAFONE / CEILING MOUNT

FINITURA STRUTTURA
FINISHES

- GRIGIO VESUVIO ANTHRACITE
- ARGILLA CLAY
- BIANCO INTONACO/WHITE
- NERO CARAVAGGIO/BLACK
- MOKA MOCHA
- CROMO/CHROME
- ORO CALIFORNIA/GOLD

CODICE
CODE

- 130500
- 130501
- 130503
- 130504
- 130505
- 130508
- 130509

FINITURA STRUTTURA
FINISHES

- ARAMEN COPPER
- ARGENTO COMETA/SILVER COMET
- OTTONE VENEZIANO/VENETIAN BRASS
- TITANIO/TITANIUM
- BRONZO RIACI/RIACI BRONZE
- VERDE COSTA/GREEN COAST
- TERRA SENESE SENESE EARTH

CODICE
CODE

- 130510
- 130512
- 130513
- 130514
- 130515
- 130516
- 130517

N.B./P.N.: PER LUNGHEZZE SUPERIORI A 200CM ORDINARE N°3 KIT / FOR LENGTHS GREATER THAN 200CM ORDER N°3 KIT

TESTATE DI CHIUSURA / DEAD ENDS

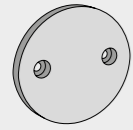

FINITURA STRUTTURA FINISHES	CODICE CODE	FINITURA STRUTTURA FINISHES	CODICE CODE
GRIGIO VESUVIO ANTHRACITE	130400	ARAMEN COPPER	130410
ARGILLA CLAY	130401	ARGENTO COMETA/SILVER COMET	130412
BIANCO INTONACO/WHITE	130403	OTTONE VENEZIANO/VENETIAN BRASS	130413
NERO CARAVAGGIO BLACK	130404	TITANIO/TITANIUM	130414
MOKA MOCHA	130405	BRONZO RIACI/RIACI BRONZE	130415
CROMO/CHROME	130408	VERDE COSTA/GREEN COAST	130416
ORO CALIFORNIA/GOLD	130409	TERRA SENESE/SENESE EARTH	130417

Nel codice sono comprese le viti per il fissaggio delle testate al profilo. Il codice contiene n° 1 testate di chiusura.
The code includes the screws for fixing the heads to the profile. The code contains 1 closing warheads

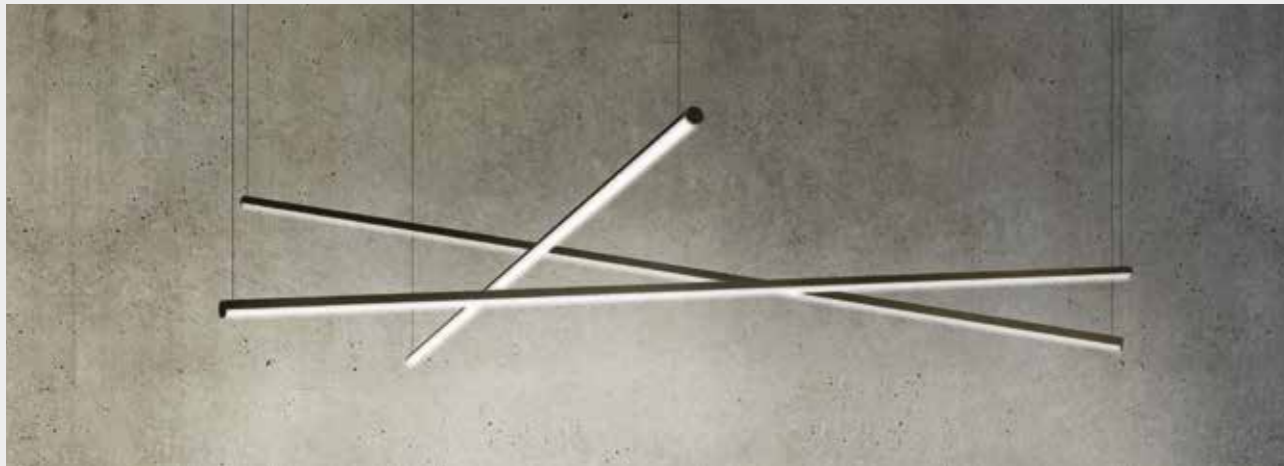

“luce perfetta”

CH012 vuole essere la nostra risposta alla continua ricerca della luce perfetta, che tende a valorizzare le forme e le dimensioni degli oggetti; siano essi opere d'arte, che prodotti commerciali. Le sue forme ideate per poter essere appoggiate su superfici piane. Lo studio compiuto per garantire il migliore posizionamento della sorgente luminosa, assicurano un ottimo comfort visivo. I Led in posizione arretrata garantiscono un basso abbagliamento e consentono di emettere una luce lineare ma allo stesso tempo concentrata che tende in assoluto a valorizzare gli oggetti, le cui forme vivono di luce naturale, con una luce artificiale.

Product CH012 wants to be our answer to the continuous research in light perfection, that makes to stand out all objects of our lives whether they be artworks or commercial products. Its sinuous shapes designed to be placed in horizontal surfaces, ensures the best comfort for your eyes. The position of LED guarantee a low dazzle and emits a linear, smooth and concrete light that exalt objects living in a natural light with a beautiful artificial light.

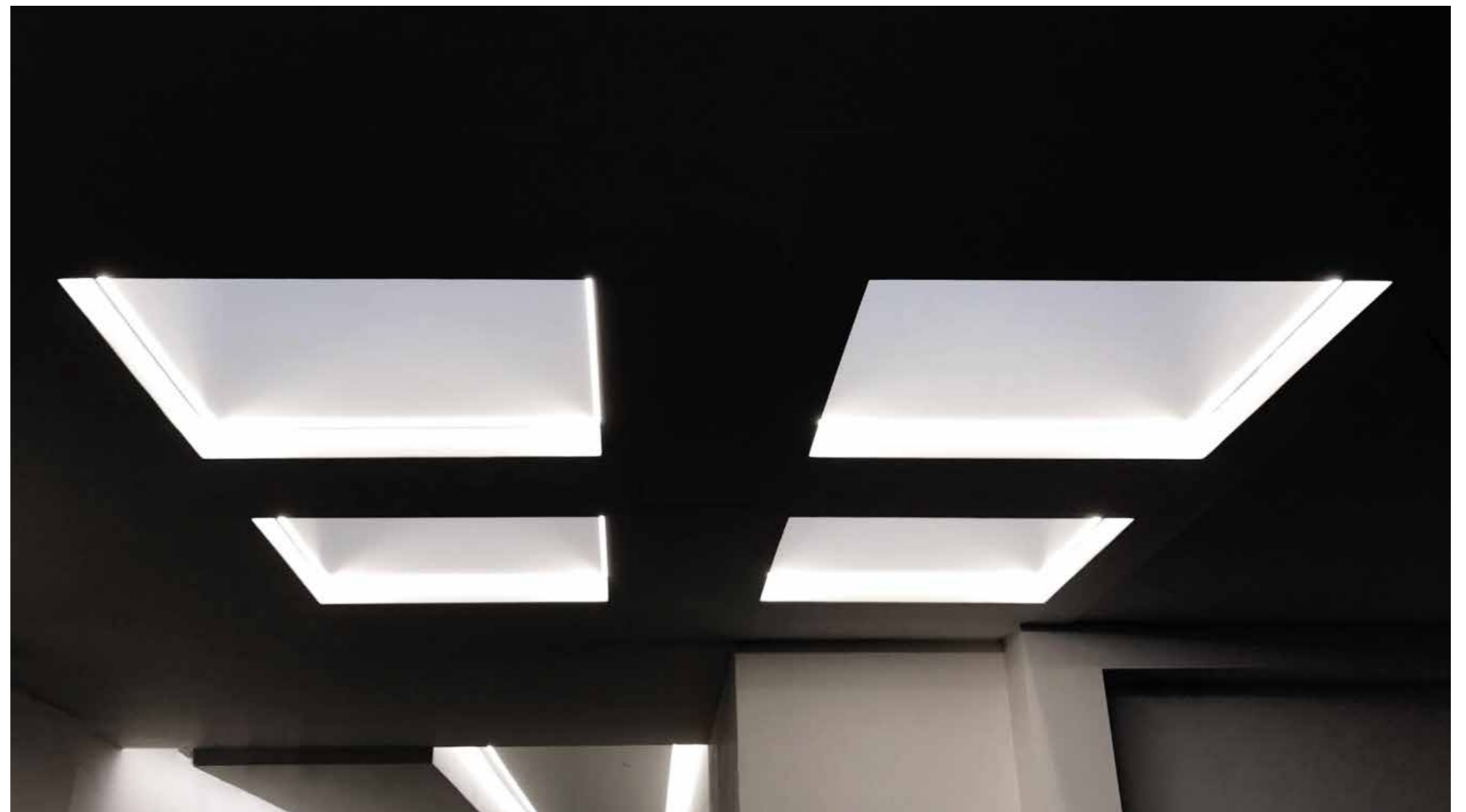



INSTALLAZIONE CON CLIP IN POLICARBONATO SU SUPERFICIE ORIZZONTALE
INSTALLATION WITH POLYCARBONATE CLIP ON HORIZONTAL SURFACE

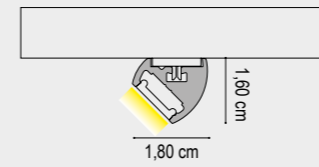

INSTALLAZIONE CON CLIP IN POLICARBONATO SU SUPERFICIE VERTICALE
INSTALLATION WITH POLYCARBONATE CLIP ON A VERTICAL SURFACE

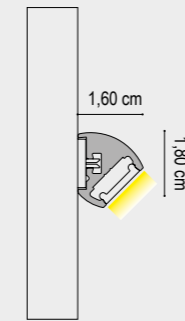

INSTALLAZIONE CON CALAMITA SU SUPERFICIE METALLICA ORIZZONTALE
INSTALLATION WITH MAGNET ON HORIZONTAL METAL SURFACE

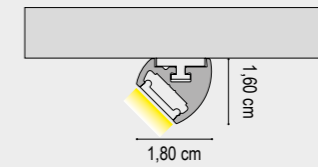

INSTALLAZIONE CON CALAMITA SU SUPERFICIE METALLICA VERTICALE
INSTALLATION WITH MAGNET ON VERTICAL METAL SURFACE

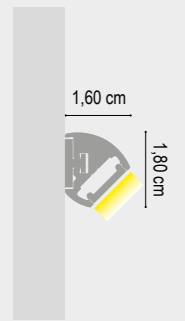

SI RACCOMANDA L'UTILIZZO DI N° 1 STAFFA MAGNETICA OGNI 25.00 cm DI PROFILO. TALE QUANTITÀ PUÒ VARIARE A SECONDA DELLA SUPERFICIE METALLICA DI INSTALLAZIONE.

WE RECOMMEND THE USE OF N° 1 MAGNETIC BRACKET EVERY 25.00 cm OF PROFILE. THIS QUANTITY MAY VARY DEPENDING ON THE METAL INSTALLATION SURFACE.

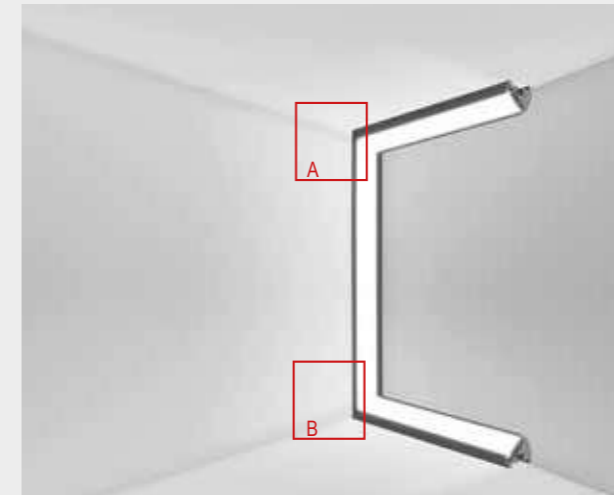

A) TAGLIO ANGOLARE - SOFFITTO/PARETE - TIPO A
A) CORNER CUT - CEILING / WALL - TYPE A
CODICE ARTICOLO / ITEM NUMBER: 190A

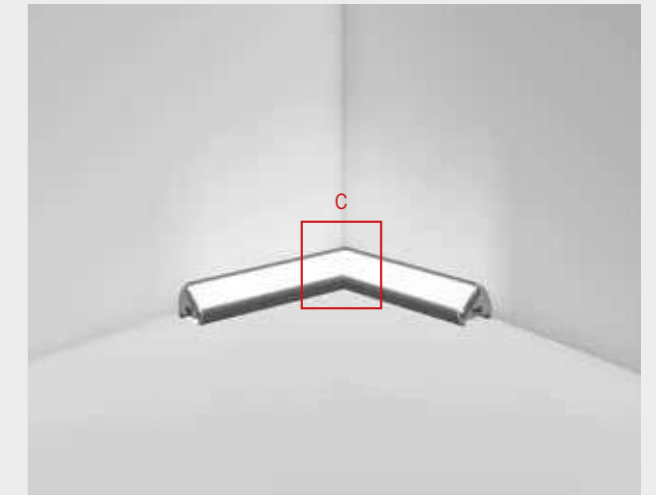

C) TAGLIO ANGOLARE - SUPERFICIE ORIZZONTALE - TIPO C
C) CORNER CUT - HORIZONTAL SURFACE - TYPE C
CODICE ARTICOLO / ITEM NUMBER: 190C

B) TAGLIO ANGOLARE - PARETE/SUP-ORIZZONTALE - TIPO B
B) CORNER CUT - WALL / SUP-HORIZONTAL - TYPE B
CODICE ARTICOLO / ITEM NUMBER: 190B

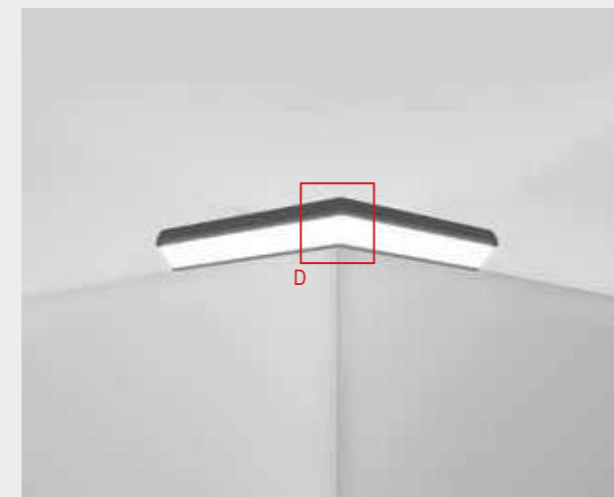

D) TAGLIO ANGOLARE - SUPERFICIE ORIZZONTALE - TIPO D
D) CORNER CUT - HORIZONTAL SURFACE - TYPE D
CODICE ARTICOLO / ITEM NUMBER: 190D



E) TAGLIO ANGOLARE - SUPERFICIE ORIZZONTALE - TIPO E
E) CORNER CUT - HORIZONTAL SURFACE - TYPE E
CODICE ARTICOLO / ITEM NUMBER: 190E

ch012

led integrato

integrated led

DATI TECNICI
TECHNICAL DATA

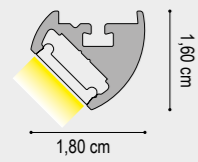

	1 cm	200 cm	300 cm
Nominal LED Flux:	1200 lm/m	2400 lm	3600 lm
Flux Tot:	960 lm/m	1920 lm	2880 lm
Output:	85 lm/W	85 lm/W	85 lm/W
CCT:	3000 K	3000 K	3000 K
CRI:	>90	>90	>90
Power Tot:	14.4 W/m	28.8 W	43.2 W
Weight:	0.40 Kg/m	0.80 Kg	1.20 Kg

Profilo/Profile: Alluminio/aluminum

Cover: Opale/opal

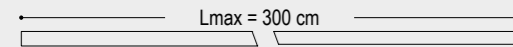

DRIVER NON INCLUSO / NOT INCLUDED

CAVO ALIMENTAZIONE: 50 cm
ALIMENTATION CABLE: 50 cm

FINITURA STRUTTURA FINISHES	DIFFUSORE DIFFUSER	1 cm CODICE CODE	200 cm CODICE CODE	300 cm CODICE CODE
GRIGIO VESUVIO ANTHRACITE		102050001	102050020	102050030
ARGILLA CLAY		102050101	102050120	102050130
ARGENTO OPACO/MATT SILVER		102050201	102050220	102050230
BIANCO INTONACO/WHITE		102050301	102050320	102050330
NERO CARAVAGGIO BLACK		102050401	102050420	102050430
MOKA MOCHA		102050501	102050520	102050530
ORO CALIFORNIA/GOLD		102050901	102050920	102050930
ARAMEN COPPER	OPALE/OPAL	102051001	102051020	102051030
ARGENTO COMETA/SILVER COMET		102051201	102051220	102051230
OTTONE VENEZIANO/BRASS		102051301	102051320	102051330
TITANIO/TITANIUM		102051401	102051420	102051430
BRONZO RIACI/RIACI BRONZE		102051501	102051520	102051530
VERDE COSTA/GREEN COAST		102051601	102051620	102051630
TERRA SENESE SENESE EARTH		102051701	102051720	102051730
CROMO/CHROME		102050801	102050820	

N.B./P.N.: LUNGHEZZA MASSIMA VERSIONE CROMO = 2,00 m / MAXIMUM LENGTH CHROME VERSION = 2.00 m
TESTATE DI CHIUSURA NON INCLUSE / DEAD ENDS NOT INCLUDED



ch012

led integrato

integrated led

DATI TECNICI
TECHNICAL DATA

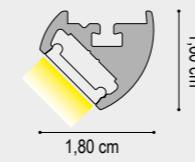

	1 cm	200 cm	300 cm
Nominal LED Flux:	1600 lm/m	3200 lm	4800 lm
Flux Tot:	1280 lm/m	2560 lm	3840 lm
Output:	85 lm/W	85 lm/W	85 lm/W
CCT:	3000 K	3000 K	3000 K
CRI:	>90	>90	>90
Power Tot:	19.2 W/m	38.4 W	57.6 W
Weight:	0.40 Kg/m	0.80 Kg	1.20 Kg

Profilo/Profile: Alluminio/aluminum

Cover: Opale/opal

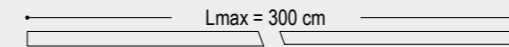

DRIVER NON INCLUSO / NOT INCLUDED

CAVO ALIMENTAZIONE: 50 cm
ALIMENTATION CABLE: 50 cm

FINITURA STRUTTURA FINISHES	DIFFUSORE DIFFUSER	1 cm CODICE CODE	200 cm CODICE CODE	300 cm CODICE CODE
GRIGIO VESUVIO ANTHRACITE		102080001	102080020	102080030
ARGILLA CLAY		102080101	102080120	102080130
ARGENTO OPACO/MATT SILVER		102080201	102080220	102080230
BIANCO INTONACO/WHITE		102080301	102080320	102080330
NERO CARAVAGGIO BLACK		102080401	102080420	102080430
MOKA MOCHA		102080501	102080520	102080530
ORO CALIFORNIA/GOLD		102080901	102080920	102080930
ARAMEN COPPER	OPALE/OPAL	102081001	102081020	102081030
ARGENTO COMETA/SILVER COMET		102081201	102081220	102081230
OTTONE VENEZIANO/BRASS		102081301	102081320	102081330
TITANIO/TITANIUM		102081401	102081420	102081430
BRONZO RIACI/RIACI BRONZE		102081501	102081520	102081530
VERDE COSTA/GREEN COAST		102081601	102081620	102081630
TERRA SENESE SENESE EARTH		102081701	102081720	102081730
CROMO/CHROME		102080801	102080820	

N.B./P.N.: LUNGHEZZA MASSIMA VERSIONE CROMO = 2,00 m / MAXIMUM LENGTH CHROME VERSION = 2.00 m
TESTATE DI CHIUSURA NON INCLUSE / DEAD ENDS NOT INCLUDED



ch012

led integrato

integrated led

ch012

led integrato

integrated led

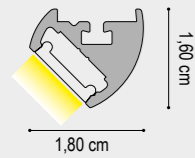

DATI TECNICI
TECHNICAL DATA

	1 cm
Nominal LED Flux:	1590 lm/m
Flux Tot:	1272 lm/m
Output:	110 lm/W
CCT:	3000 K
CRI:	>95
Power Tot:	14.4 W/m
Weight:	0.40 Kg/m

Profilo/Profile: Alluminio/aluminum
Cover: Opale/opal

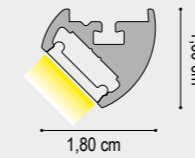

DATI TECNICI
TECHNICAL DATA

	1 cm
Nominal LED Flux:	2200 lm/m
Flux Tot:	1760 lm/m
Output:	110 lm/W
CCT:	3000 K
CRI:	>90
Power Tot:	20 W/m
Weight:	0.40 Kg/m

Profilo/Profile: Alluminio/aluminum
Cover: Opale/opal

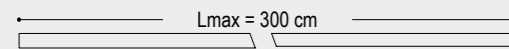

DRIVER NON INCLUSO / NOT INCLUDED

CAVO ALIMENTAZIONE: 50 cm
ALIMENTATION CABLE: 50 cm

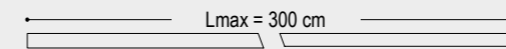

DRIVER NON INCLUSO / NOT INCLUDED

CAVO ALIMENTAZIONE: 50 cm
ALIMENTATION CABLE: 50 cm

FINITURA STRUTTURA FINISHES	DIFFUSORE DIFFUSER	CODICE 2700K CODE 2700K	CODICE 3000K CODE 3000K	CODICE 4000K CODE 4000K
GRIGIO VESUVIO ANTHRACITE	OPALE/OPAL	102G100001	102G200001	102G300001
ARGILLA CLAY		102G101001	102G201001	102G301001
ARGENTO OPACO/MATT SILVER		102G102001	102G202001	102G302001
BIANCO INTONACO/WHITE		102G103001	102G203001	102G303001
NERO CARAVAGGIO BLACK		102G104001	102G204001	102G304001
MOKA MOCHA		102G105001	102G205001	102G305001
CROMO CHROME		102G108001	102G208001	102G208001
ORO CALIFORNIA/GOLD		102G109001	102G209001	102G309001
ARAMEN COPPER		102G110001	102G210001	102G310001
ARGENTO COMETA/SILVER COMET		102G112001	102G212001	102G312001
OTTONE VENEZIANO/BRASS		102G113001	102G213001	102G313001
TITANIO/TITANIUM		102G114001	102G214001	102G314001
BRONZO RIACI/RIACI BRONZE		102G115001	102G215001	102G315001
VERDE COSTA/GREEN COAST		102G116001	102G216001	102G316001
TERRA SENESE SENESE EARTH		102G117001	102G217001	102G317001

N.B./P.N.: LUNGHEZZA MASSIMA VERSIONE CROMO = 2,00 m / MAXIMUM LENGTH CHROME VERSION = 2.00 m
TESTATE DI CHIUSURA NON INCLUSE / DEAD ENDS NOT INCLUDED

FINITURA STRUTTURA FINISHES	DIFFUSORE DIFFUSER	CODICE 2700K CODE 2700K	CODICE 3000K CODE 3000K	CODICE 4000K CODE 4000K
GRIGIO VESUVIO ANTHRACITE	OPALE/OPAL	1024600001	1024700001	1024800001
ARGILLA CLAY		1024601001	1024701001	1024801001
ARGENTO OPACO/MATT SILVER		1024602001	1024702001	1024802001
BIANCO INTONACO/WHITE		1024603001	1024703001	1024803001
NERO CARAVAGGIO BLACK		1024604001	1024704001	1024804001
MOKA MOCHA		1024605001	1024705001	1024805001
CROMO CHROME		1024608001	1024708001	1024808001
ORO CALIFORNIA/GOLD		1024609001	1024709001	1024809001
ARAMEN COPPER		1024610001	1024710001	1024810001
ARGENTO COMETA/SILVER COMET		1024612001	1024712001	1024812001
OTTONE VENEZIANO/BRASS		1024613001	1024713001	1024813001
TITANIO/TITANIUM		1024614001	1024714001	1024814001
BRONZO RIACI/RIACI BRONZE		1024615001	1024715001	1024815001
VERDE COSTA/GREEN COAST		1024616001	1024716001	1024816001
TERRA SENESE SENESE EARTH		1024617001	1024717001	1024817001

N.B./P.N.: LUNGHEZZA MASSIMA VERSIONE CROMO = 2,00 m / MAXIMUM LENGTH CHROME VERSION = 2.00 m
TESTATE DI CHIUSURA NON INCLUSE / DEAD ENDS NOT INCLUDED



ch012

profilo e diffusore

profile and diffuser

ch012

profilo e diffusore

profile and diffuser

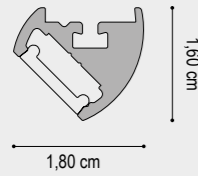

Profilo in alluminio
Aluminium profile

Diffusore in policarbonato
Polycarbonate diffuser

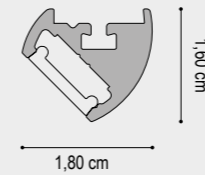

Profilo in alluminio
Aluminium profile

Diffusore in policarbonato
Polycarbonate diffuser

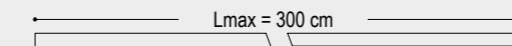
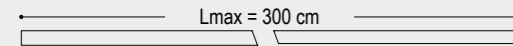

FINITURA STRUTTURA
FINISHES

- GRIGIO VESUVIO ANTHRACITE
- ARGILLA CLAY
- ARGENTO OPACO MATT SILVER
- BIANCO INTONACO/WHITE
- NERO CARAVAGGIO BLACK
- MOKA MOCHA
- ALLUMINIO NATURALE ALUMINUM
- ORO CALIFORNIA/GOLD
- ARAMEN COPPER
- ARGENTO COMETA/SILVER COMET
- OTTONE VENEZIANO/BRASS
- TITANIO/TITANIUM
- BRONZO RIACI/RIACI BRONZE
- VERDE COSTA/GREEN COAST
- TERRA SENESE SENESE EARTH
- CROMO CHROME

DIFFUSORE
DIFFUSER

OPALE/OPAL

1 cm 200 cm 300 cm

CODICE CODE	CODICE CODE	CODICE CODE
102CP00001	102CP00200	102CP00300
102CP01001	102CP01200	102CP01300
102CP02001	102CP02200	102CP02300
102CP03001	102CP03200	102CP03300
102CP04001	102CP04200	102CP04300
102CP05001	102CP05200	102CP05300
102CP06001	102CP06200	102CP06300
102CP09001	102CP09200	102CP09300
102CP10001	102CP10200	102CP10300
102CP12001	102CP12200	102CP12300
102CP13001	102CP13200	102CP13300
102CP14001	102CP14200	102CP14300
102CP15001	102CP15200	102CP15300
102CP16001	102CP16200	102CP16300
102CP17001	102CP17200	102CP17300
102CP08001	102CP08200	

N.B./P.N.:

LUNGHEZZA MASSIMA VERSIONE CROMO = 2,00 m / MAXIMUM LENGTH CHROME VERSION = 2.00 m

FINITURA STRUTTURA
FINISHES

- GRIGIO VESUVIO ANTHRACITE
- ARGILLA CLAY
- ARGENTO OPACO MATT SILVER
- BIANCO INTONACO/WHITE
- NERO CARAVAGGIO BLACK
- MOKA MOCHA
- ALLUMINIO NATURALE ALUMINUM
- ORO CALIFORNIA/GOLD
- ARAMEN COPPER
- ARGENTO COMETA/SILVER COMET
- OTTONE VENEZIANO/BRASS
- TITANIO/TITANIUM
- BRONZO RIACI/RIACI BRONZE
- VERDE COSTA/GREEN COAST
- TERRA SENESE SENESE EARTH
- CROMO CHROME

DIFFUSORE
DIFFUSER

SATINATA/SATIN

1 cm 200 cm 300 cm

CODICE CODE	CODICE CODE	CODICE CODE
102CS00001	102CS00200	102CS00300
102CS01001	102CS01200	102CS01300
102CS02001	102CS02200	102CS02300
102CS03001	102CS03200	102CS03300
102CS04001	102CS04200	102CS04300
102CS05001	102CS05200	102CS05300
102CS06001	102CS06200	102CS06300
102CS09001	102CS09200	102CS09300
102CS10001	102CS10200	102CS10300
102CS12001	102CS12200	102CS12300
102CS13001	102CS13200	102CS13300
102CS14001	102CS14200	102CS14300
102CS15001	102CS15200	102CS15300
102CS16001	102CS16200	102CS16300
102CS17001	102CS17200	102CS17300
102CS08001	102CS08200	

N.B./P.N.:

LUNGHEZZA MASSIMA VERSIONE CROMO = 2,00 m / MAXIMUM LENGTH CHROME VERSION = 2.00 m

LED compatibili / LED compatibility

HIGH QUALITY CRI>90 CRI>95	HIGH OUTPUT CRI>90 CRI>95	HIGH EFFICIENT CRI>90 CRI>95	HIGH INTENSITY CRI>90 CRI>95	LOW POWER CRI>90	ULTRA SLIM CRI>90 CRI>95 CRI>97	RGB	RGB WHITE	RGB TW	TUNABLE WHITE
9,6W 14,4W 19,2W	12,3W 14,4W 19,2W 20W 24W	12,3W 14,4W 19,2W 20W 24W	24W 24W (700 LED)	6W	9,6W 12W 14,4W	14W	14W	14,4W 23W	19,2W

LED compatibili / LED compatibility

HIGH QUALITY CRI>90 CRI>95	HIGH OUTPUT CRI>90 CRI>95	HIGH EFFICIENT CRI>90 CRI>95	HIGH INTENSITY CRI>90 CRI>95	LOW POWER CRI>90	ULTRA SLIM CRI>90 CRI>95 CRI>97	RGB	RGB WHITE	RGB TW	TUNABLE WHITE
9,6W 14,4W 19,2W	12,3W 14,4W 19,2W 20W 24W	12,3W 14,4W 19,2W 20W 24W	24W 24W (700 LED)	6W	9,6W 12W 14,4W	14W	14W	14,4W 23W	19,2W



TESTATE DI CHIUSURA / DEAD ENDS

	FINITURA STRUTTURA FINISHES	CODICE CODE	FINITURA STRUTTURA FINISHES	CODICE CODE
	GRIGIO VESUVIO ANTHRACITE	1020400000	ORO CALIFORNIA/GOLD	1020409000
	ARGILLA CLAY	1020401000	ARAMEN COPPER	1020410000
	ARGENTO OPACO/MATT SILVER	1020402000	ARGENTO COMETA/SILVER COMET	1020412000
	BIANCO INTONACO/WHITE	1020403000	OTTONE VENEZIANO BRASS	1020413000
	NERO CARAVAGGIO BLACK	1020404000	TITANIO/TITANIUM	1020414000
	MOKA MOCHA	1020405000	BRONZO RIACI/RIACI BRONZE	1020415000
	ALLUMINIO NATURALE/ALUMINUM	1020406000	VERDE COSTA/GREEN COAST	1020416000
	CROMO/CHROME	1020408000	TERRA SENESE/SENESE EARTH	1020417000

Nel codice sono comprese le viti per il fissaggio delle testate al profilo. Il codice contiene n° 1 testate di chiusura. / The code includes the screws for fixing the heads to the profile. The code contains 1 closing warheads

GIUNTI / JOINTS

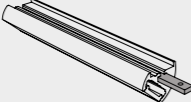
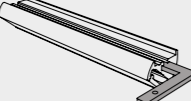
		FINITURA FINISHES	CODICE CODE
GIUNTO LINEA CONTINUA / STRAIGHT JOINT		ALLUMINIO NATURALE/ALUMINUM	1010500006
Accessorio per giunzioni meccaniche lineari Accessory for linear mechanical joints			
GIUNTO 90° ORIZZONTALE / HORIZONTAL JOINT 90°		ALLUMINIO NATURALE/ALUMINUM	1010500005
Accessorio per giunzioni meccaniche con angolo 90° Accessory for linear mechanical joints with 90° angle			
GIUNTO 90° VERTICALE / VERTICAL JOINT 90°		ALLUMINIO NATURALE/ALUMINUM	1010500007
Accessorio per giunzioni meccaniche con angolo 90° Accessory for linear mechanical joints with 90° angle			

Nel codice sono compresi i grani per il fissaggio del giunto
The code includes the grains for fixing the joint.

STAFFA DI FISSAGGIO / MOUNTING CLIP

	FINITURA FINISHES	CODICE CODE
	SUPERFICI PIANE 2mm EVEN SURFACE 2mm	1020500003
	SUPERFICI IRREGOLARI 3,5mm UNEVEN SURFACE 3,5mm	1020500004

Accessorio per fissaggio a plafone/superficie. Quantità raccomandata: 1 pz ogni 50 cm di profilo
Ceiling/surface mounting accessory. Recommended quantity: 1 pc every 50 cm of profile

CALAMITA / MAGNET

	CODICE CODE	PORTATA RANGE
	102050001	1 Kg
	1020500210	2 Kg

Quantità raccomandata: 1 pz ogni 25cm di profilo
Recommended quantity: 1 pc every 25cm of profile

INTERRUTTORE DIMMERABILE+INSTALLAZIONE / DIMMABLE SWITCH+INSTALLATION

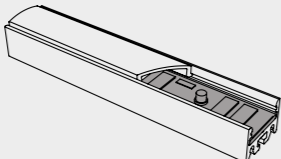



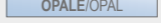
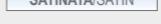







DATI TECNICI TECHNICAL DATA	FINITURA STRUTTURA FINISHES	CODICE CODE
<p>Accessorio che consente l'accensione e lo spegnimento dei LED e, a seconda della pressione, la regolazione dell'intensità luminosa. Accessory that allows the switching on and off of the LEDs and, depending on the pressure, the regulation of the light intensity.</p> <p>Tensione di alimentazione: 12-24V DC Supply voltage: 12-24V DC Corrente d'uscita: 4A max Output current: 4A max ON / OFF: contact < 0.7 s DIMMER: contact > 0.7 s</p>		ALLUMINIO NATURALE/ALUMINUM 98244

VERSIONE KIT / KIT VERSION

	DIFFUSORE DIFFUSER	FINITURA FINISHES	200 cm CODICE CODE
ARTICOLI INCLUSI NEL CODICE ARTICLES INCLUDED IN THE CODE		ARGENTO OPACO/MATT SILVER BIANCO INTONACO/WHITE NERO CARAVAGGIO BLACK	102P22 102P32 102P42
		ARGENTO OPACO/MATT SILVER BIANCO INTONACO/WHITE NERO CARAVAGGIO BLACK	102S22 102S32 102S42

Profilo / Profile
Diffusore / Diffuser
N°2 testate di chiusura / No. 2 closing heads
N°3 staffe di fissaggio per superfici irregolari 3mm
N°3 fixing brackets for uneven surfaces 3mm

LAVORAZIONI / PROCESSING

DATI TECNICI TECHNICAL DATA	CODICE CODE
 TAGLIO ANGOLARE 90° (PER ANGOLI FORMATI DA DUE PROFILI) TIPO A 90° CORNER CUT (FOR CORNERS MADE OF TWO PROFILES) - TYPE A	190A
 TAGLIO ANGOLARE 90° (PER ANGOLI FORMATI DA DUE PROFILI) TIPO B 90° CORNER CUT (FOR CORNERS MADE OF TWO PROFILES) - TYPE B	190B
 TAGLIO ANGOLARE 90° (PER ANGOLI FORMATI DA DUE PROFILI) TIPO C 90° CORNER CUT (FOR CORNERS MADE OF TWO PROFILES) - TYPE C	190C
 TAGLIO ANGOLARE 90° (PER ANGOLI FORMATI DA DUE PROFILI) TIPO D 90° CORNER CUT (FOR CORNERS MADE OF TWO PROFILES) - TYPE D	190D
 TAGLIO ANGOLARE 90° (PER ANGOLI FORMATI DA DUE PROFILI) TIPO E 90° CORNER CUT (FOR CORNERS MADE OF TWO PROFILES) - TYPE E	190E
 TAGLIO ANGOLARE CUSTOM (PER ANGOLI FORMATI DA DUE PROFILI) CUSTOM CORNER CUT (FOR CORNERS MADE OF TWO PROFILES)	190N
 ASOLA / SLOT	100A
 FORO / HOLE	100F
 CABLAGGIO - COLLAUDO - CE AL CENTIMETRO INSTALLATION AND TESTING LED MODULE AT CENTIMETER	1021
 CONNETTORE MASCHIO/FEMMINA MALE/FEMALE CONNECTOR	98CFM
 CONNETTORE MASCHIO/FEMMINA MONTATO NEL PRODOTTO MALE/FEMALE CONNECTOR FITTED IN THE PRODUCT	98MFM
 CAVO DI ALIMENTAZIONE 2X0,50 BIANCO 1CM POWER CABLE 2X0,50 WHITE 1CM	98CB001
 CAVO DI ALIMENTAZIONE 2X0,50 NERO 1CM POWER CABLE 2X0,50 BLACK 1CM	98CN001

“fascio luminoso a 45°”

LC020 grazie alla sua forma innovativa e al posizionamento della sorgente luminosa abbinato al diffusore in policarbonato opalino arretrato ed inclinato, consente un fascio luminoso a 45°. Se abbinato alla nostra gamma di led ad alta resa cromatica CRI >95 e CRI > 97 assolve al compito di esaltare gli oggetti nei colori, e nelle forme, contribuendo ad esaltarne l'immagine nella sua interezza.

LC020 thanks to its innovative shape and the positioning of the light source combined with the backward and inclined opal polycarbonate diffuser, allows a 45 ° light beam. If combined with our range of high color rendering LEDs CRI> 95 and CRI> 97, it fulfills the task of enhancing objects in colors and shapes, contributing to enhancing their image in its entirety.



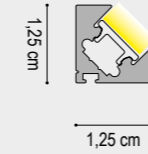

INSTALLAZIONE AD INCASSO
RECESSED INSTALLATION

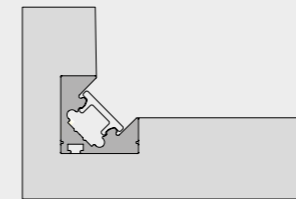

INSTALLAZIONE SU SUPERFICI ORIZZONTALI E VERTICALI
INSTALLATION ON HORIZONTAL AND VERTICAL SURFACES

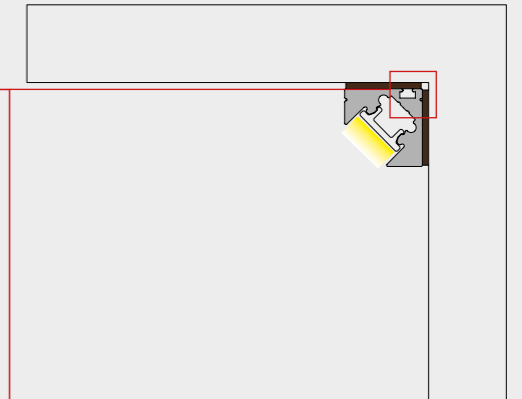

IL PRODOTTO LC020 NON PREVEDE ACCESSORI PER L'INSTALLAZIONE. IL FISSAGGIO A SUPERFICIE DEVE ESSERE REALIZZATO MEDIANTE APPOSITI COLLANTI O NASTRO BIADESIVO. SI RACCOMANDA DI SCEGLIERE IL METODO DI FISSAGGIO ADATTO ALLA SUPERFICIE DI INSTALLAZIONE.

THE LC020 PRODUCT DOES NOT PROVIDE ACCESSORIES FOR INSTALLATION. SURFACE MOUNTING MUST BE MADE USING SPECIAL ADHESIVES OR DOUBLE-SIDED TAPE. IT IS RECOMMENDED TO CHOOSE THE FASTENING METHOD SUITABLE FOR THE INSTALLATION SURFACE.

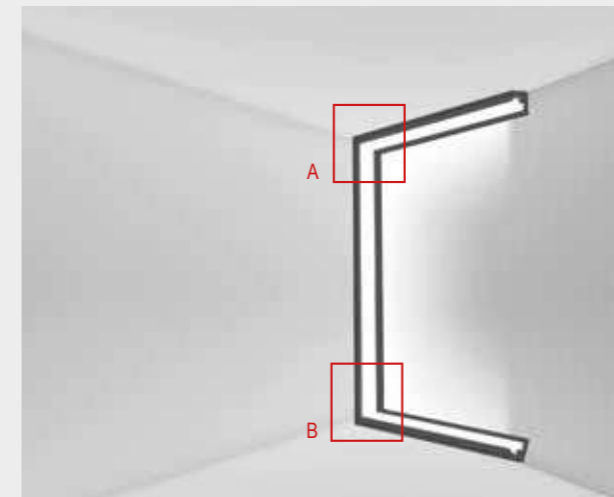

A) TAGLIO ANGOLARE - SOFFITTO/PARETE - TIPO A
A) CORNER CUT - CEILING / WALL - TYPE A
CODICE ARTICOLO / ITEM NUMBER: 190A

B) TAGLIO ANGOLARE - PARETE/SUP-ORIZZONTALE - TIPO B
B) CORNER CUT - WALL / SUP-HORIZONTAL - TYPE B
CODICE ARTICOLO / ITEM NUMBER: 190B

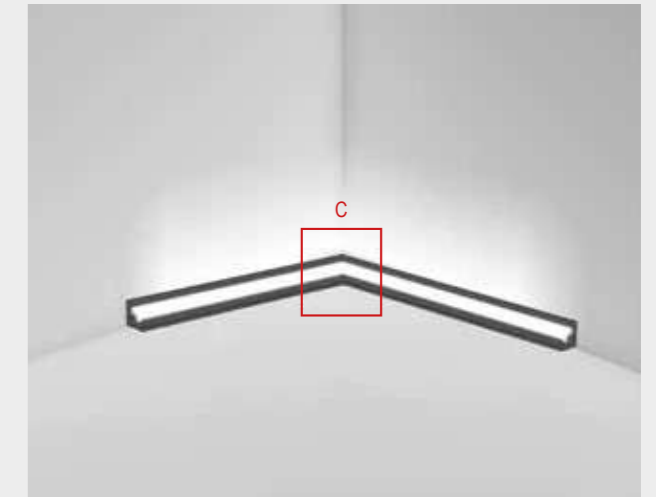

C) TAGLIO ANGOLARE - SUPERFICIE ORIZZONTALE - TIPO C
C) CORNER CUT - HORIZONTAL SURFACE - TYPE C
CODICE ARTICOLO / ITEM NUMBER: 190C

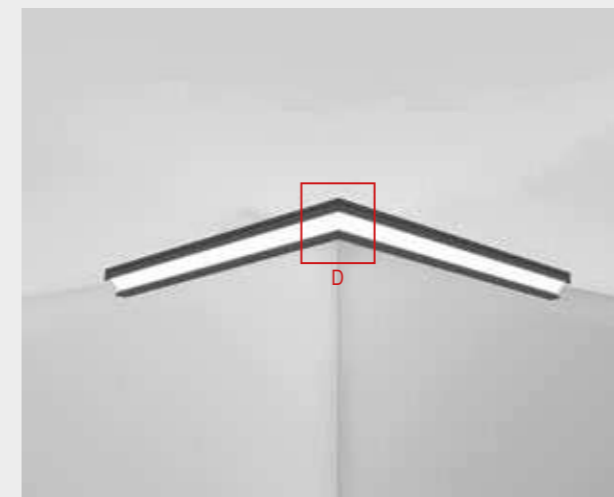

D) TAGLIO ANGOLARE - SUPERFICIE ORIZZONTALE - TIPO D
D) CORNER CUT - HORIZONTAL SURFACE - TYPE D
CODICE ARTICOLO / ITEM NUMBER: 190D

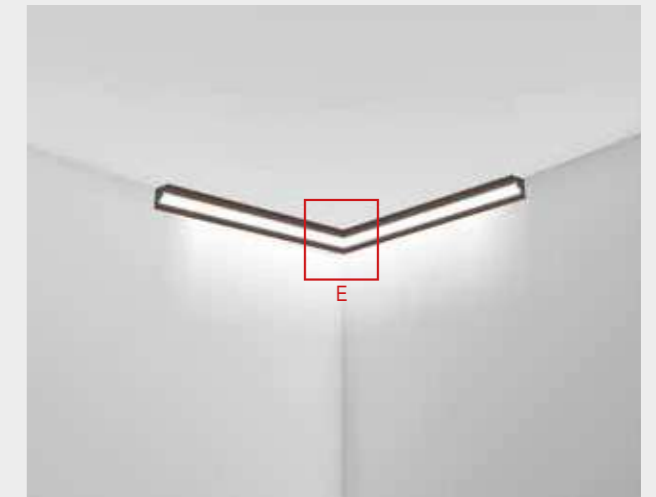

E) TAGLIO ANGOLARE - SUPERFICIE ORIZZONTALE - TIPO E
E) CORNER CUT - HORIZONTAL SURFACE - TYPE E
CODICE ARTICOLO / ITEM NUMBER: 190E

Ic020

led integrato

integrated led

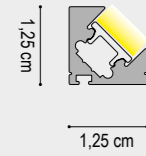
DATI TECNICI
 TECHNICAL DATA

	1 cm
Nominal LED Flux:	1900 lm/m
Flux Tot:	1520 lm/m
Output:	158 lm/W
CCT:	3000 K
CRI:	>90
Power Tot:	12.0W/m
Weight:	0.20 Kg/m

 Profilo/Profile: Alluminio/aluminum
 Cover: Opale/opal

DRIVER NON INCLUSO / NOT INCLUDED

CAVO ALIMENTAZIONE: 50 cm
ALIMENTATION CABLE: 50 cm

Lmax = 300 cm

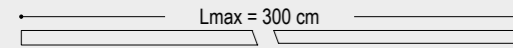

1 cm

FINITURA STRUTTURA
 FINISHES

GRIGIO VESUVIO ANTHRACITE
ARGILLA CLAY
ARGENTO OPACO/MATT SILVER
BIANCO INTONACO/WHITE
NERO CARAVAGGIO BLACK
MOKA MOCHA
CROMO/CHROME
ORO CALIFORNIA/GOLD
ARAMEN COPPER
ARGENTO COMETA/SILVER COMET
OTTONE VENEZIANO BRASS
TITANIO/TITANIUM
BRONZO RIACI/RIACI BRONZE
VERDE COSTA/GREEN COAST
TERRA SENESE SENESE EARTH

DIFFUSORE
 DIFFUSER

OPALE/OPAL

CODICE 2700K	CODICE 3000K	CODICE 4000K
CODE 2700K	CODE 3000K	CODE 4000K
1254000001	1255000001	1256000001
1254010001	1255010001	1256010001
1254020001	1255020001	1256020001
1254030001	1255030001	1256030001
1254040001	1255040001	1256040001
1254050001	1255050001	1256050001
1254080001	1255080001	1256080001
1254090001	1255090001	1256090001
1254100001	1255100001	1256100001
1254120001	1255120001	1256120001
1254130001	1255130001	1256130001
1254140001	1255140001	1256140001
1254150001	1255150001	1256150001
1254160001	1255160001	1256160001
1254170001	1255170001	1256170001

N.B./P.N.: LUNGHEZZA MASSIMA VERSIONE CROMO = 2,00 m / MAXIMUM LENGTH CHROME VERSION = 2.00 m
 TESTATE DI CHIUSURA NON INCLUSE / DEAD ENDS NOT INCLUDED

Ic020

led integrato

integrated led

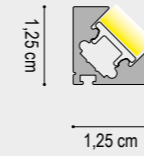
DATI TECNICI
 TECHNICAL DATA

	1 cm
Nominal LED Flux:	1560 lm/m
Flux Tot:	1248 lm/m
Output:	130 lm/W
CCT:	3000 K
CRI:	>97 - R9>90
Power Tot:	12.0W/m
Weight:	0.20 Kg/m

 Profilo/Profile: Alluminio/aluminum
 Cover: Opale/opal

DRIVER NON INCLUSO / NOT INCLUDED

CAVO ALIMENTAZIONE: 50 cm
ALIMENTATION CABLE: 50 cm

Lmax = 300 cm

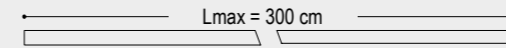

1 cm

FINITURA STRUTTURA
 FINISHES

GRIGIO VESUVIO ANTHRACITE
ARGILLA CLAY
ARGENTO OPACO/MATT SILVER
BIANCO INTONACO/WHITE
NERO CARAVAGGIO BLACK
MOKA MOCHA
CROMO/CHROME
ORO CALIFORNIA/GOLD
ARAMEN COPPER
ARGENTO COMETA/SILVER COMET
OTTONE VENEZIANO BRASS
TITANIO/TITANIUM
BRONZO RIACI/RIACI BRONZE
VERDE COSTA/GREEN COAST
TERRA SENESE SENESE EARTH

DIFFUSORE
 DIFFUSER

OPALE/OPAL

CODICE 2700K	CODICE 3000K	CODICE 4000K
CODE 2700K	CODE 3000K	CODE 4000K
1296000001	1297000001	1298000001
1296010001	1297010001	1298010001
1296020001	1297020001	1298020001
1296030001	1297030001	1298030001
1296040001	1297040001	1298040001
1296050001	1297050001	1298050001
1296080001	1297080001	1298080001
1296090001	1297090001	1298090001
1296100001	1297100001	1298100001
1296120001	1297120001	1298120001
1296130001	1297130001	1298130001
1296140001	1297140001	1298140001
1296150001	1297150001	1298150001
1296160001	1297160001	1298160001
1296170001	1297170001	1298170001

N.B./P.N.: LUNGHEZZA MASSIMA VERSIONE CROMO = 2,00 m / MAXIMUM LENGTH CHROME VERSION = 2.00 m
 TESTATE DI CHIUSURA NON INCLUSE / DEAD ENDS NOT INCLUDED



Profilo in alluminio
Aluminium profile

Diffusore in policarbonato
Polycarbonate diffuser

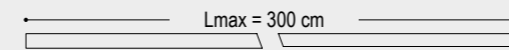
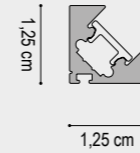

**FINITURA STRUTTURA
FINISHES**

- GRIGIO VESUVIO ANTHRACITE
- ARGILLA CLAY
- ARGENTO OPACO MATT SILVER
- BIANCO INTONACO/WHITE
- NERO CARAVAGGIO BLACK
- MOKA MOCHA
- ALLUMINIO NATURALE/ALUMINUM
- ORO CALIFORNIA/GOLD
- ARAMEN COPPER
- ARGENTO COMETA/SILVER COMET
- OTTONE VENEZIANO BRASS
- TITANIO/TITANIUM
- BRONZO RIACI/RIACI BRONZE
- VERDE COSTA/GREEN COAST
- TERRA SENESE SENESE EARTH
- CROMO/CHROME

**DIFFUSORE
DIFFUSER**

OPALE/OPAL

1 cm 200 cm 300 cm

CODICE CODE	CODICE CODE	CODICE CODE
12CP00001	12CP000200	12CP000300
12CP010001	12CP010200	12CP010300
12CP020001	12CP020200	12CP020300
12CP030001	12CP030200	12CP030300
12CP040001	12CP040200	12CP040300
12CP050001	12CP050200	12CP050300
12CP060001	12CP060200	12CP060300
12CP090001	12CP090200	12CP090300
12CP100001	12CP100200	12CP100300
12CP120001	12CP120200	12CP120300
12CP130001	12CP130200	12CP130300
12CP140001	12CP140200	12CP140300
12CP150001	12CP150200	12CP150300
12CP160001	12CP160200	12CP160300
12CP170001	12CP170200	12CP170300
12CP080001	12CP080200	

N.B./P.N.: LUNGHEZZA MASSIMA VERSIONE CROMO = 2,00 m / MAXIMUM LENGTH CHROME VERSION = 2.00 m
TESTATE DI CHIUSURA NON INCLUSE / DEAD ENDS NOT INCLUDED

LED compatibili / LED compatibility

HIGH QUALITY CRI>90 CRI>95	HIGH OUTPUT CRI>90 CRI>95	HIGH EFFICIENT CRI>90 CRI>95	HIGH INTENSITY CRI>90 CRI>95	LOW POWER CRI>90	ULTRA SLIM CRI>90 CRI>95 CRI>97	RGB	RGB WHITE	RGB TW	TUNABLE WHITE
✗	✗	✗	✗	✗	9,6W 12W 14,4W	✗	✗	✗	✗

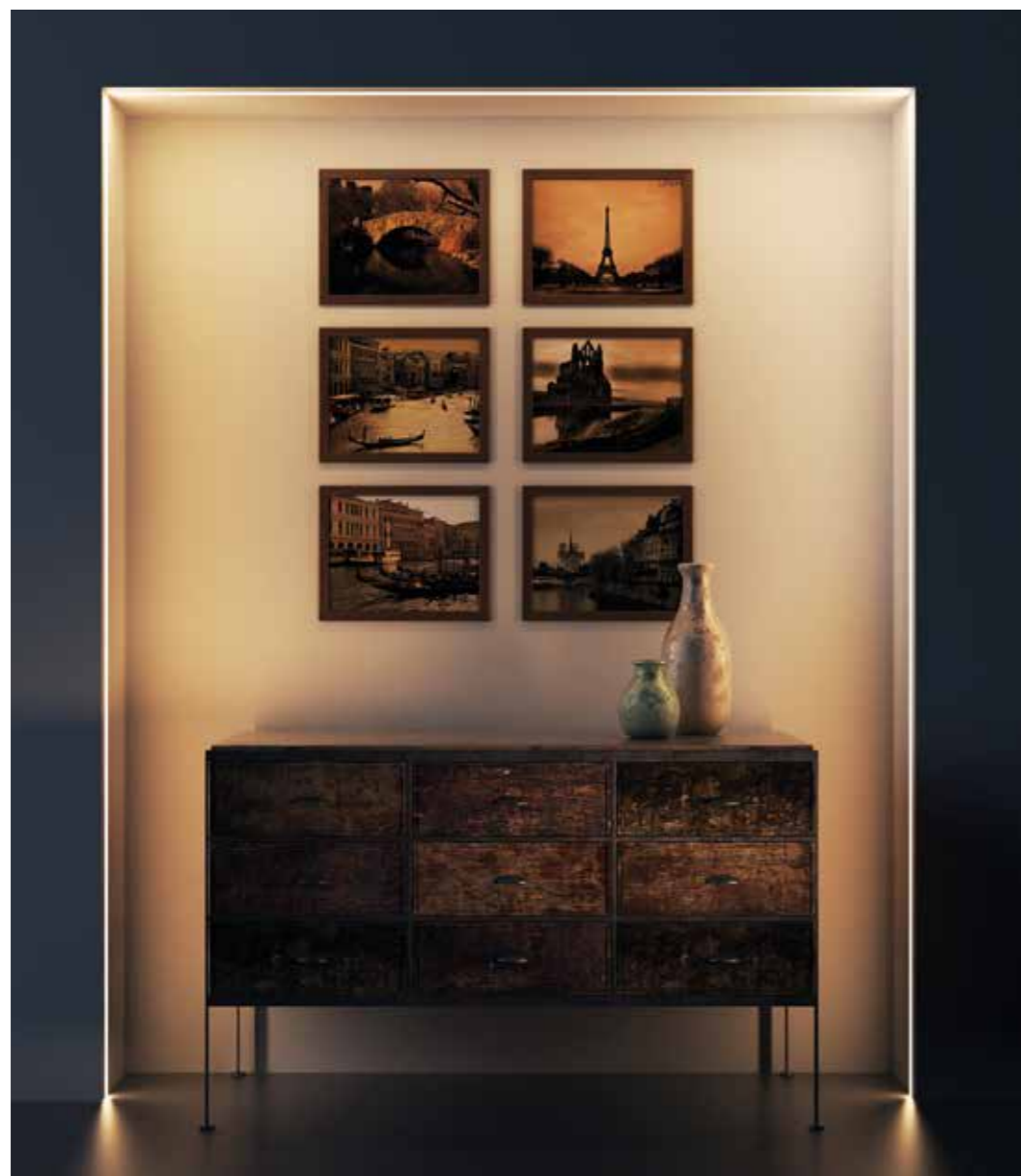





TESTATE DI CHIUSURA / DEAD ENDS

FINITURA STRUTTURA FINISHES	CODICE CODE	FINITURA STRUTTURA FINISHES	CODICE CODE
GRIGIO VESUVIO ANTHRACITE	120400	ORO CALIFORNIA/GOLD	120409
ARGILLA CLAY	120401	ARAMEN COPPER	120410
ARGENTO OPACO/MATT SILVER	120402	ARGENTO COMETA/SILVER COMET	120412
BIANCO INTONACO/WHITE	120403	OTTONE VENEZIANO/BRASS	120413
NERO CARAVAGGIO BLACK	120404	TITANIO/TITANIUM	120414
MOKA MOCHA	120405	BRONZO RIACI/RIACI BRONZE	120415
ALLUMINIO NATURALE/ALUMINUM	120406	VERDE COSTA/GREEN COAST	120416
CROMO/CHROME	120408	TERRA SENESE SENESE EARTH	120417

Nel codice sono comprese le viti per il fissaggio delle testate al profilo. Il codice contiene n° 1 testate di chiusura. / The code includes the screws for fixing the heads to the profile. The code contains 1 closing warheads

LAVORAZIONI / PROCESSING

DATI TECNICI TECHNICAL DATA	CODICE CODE
 TAGLIO ANGOLARE 90° (PER ANGOLI FORMATI DA DUE PROFILI) TIPO A 90 ° CORNER CUT (FOR CORNERS MADE OF TWO PROFILES) - TYPE A	190A
TAGLIO ANGOLARE 90° (PER ANGOLI FORMATI DA DUE PROFILI) TIPO B 90 ° CORNER CUT (FOR CORNERS MADE OF TWO PROFILES) - TYPE B	190B
TAGLIO ANGOLARE 90° (PER ANGOLI FORMATI DA DUE PROFILI) TIPO C 90 ° CORNER CUT (FOR CORNERS MADE OF TWO PROFILES) - TYPE C	190C
TAGLIO ANGOLARE 90° (PER ANGOLI FORMATI DA DUE PROFILI) TIPO D 90 ° CORNER CUT (FOR CORNERS MADE OF TWO PROFILES) - TYPE D	190D
TAGLIO ANGOLARE 90° (PER ANGOLI FORMATI DA DUE PROFILI) TIPO E 90 ° CORNER CUT (FOR CORNERS MADE OF TWO PROFILES) - TYPE E	190E
TAGLIO ANGOLARE CUSTOM (PER ANGOLI FORMATI DA DUE PROFILI) CUSTOM CORNER CUT (FOR CORNERS MADE OF TWO PROFILES)	190N
 ASOLA / SLOT	100A
FORO / HOLE	100F
 CABLAGGIO - COLLAUDO - CE AL CENTIMETRO INSTALLATION AND TESTING LED MODULE AT CENTIMETER	1201
 CONNETTORE MASCHIO/FEMMINA MALE/FEMALE CONNECTOR	98CFM
CONNETTORE MASCHIO/FEMMINA MONTATO NEL PRODOTTO MALE/FEMALE CONNECTOR FITTED IN THE PRODUCT	98MFM
 CAVO DI ALIMENTAZIONE 2X0,50 BIANCO 1CM POWER CABLE 2X0,50 WHITE 1CM	98CB001
CAVO DI ALIMENTAZIONE 2X0,50 NERO 1CM POWER CABLE 2X0,50 BLACK 1CM	98CN001

“prodotto estremamente versatile”

LC014 è il brillante risultato della nostra vocazione alla continua ricerca di soluzioni luminose che tendono a risolvere e soddisfare le esigenze illuminotecniche della nostra clientela. La finalità iniziale del nostro studio era quella di realizzare un prodotto estremamente versatile.

Il Design studiato per rendere possibile un'installazione da incasso, semi incasso o da parete. LC014 è la soluzione ideale per illuminare piccoli spazi come vetrine oppure ambienti più grandi usandolo anche come cornice luminosa a luce indiretta per valorizzare soffitti a volte oppure può essere utilizzata come luce diretta per illuminare sale, corridoi, ecc.

LC014 is the brilliant result of our continuous researches for lighting solutions, which tend to resolve and satisfy our customers lighting requirements. The original purpose of our study was to create an extremely versatile product, the design studied to realize recessed, semi-recessed or on wall installation's. LC014 is a perfect solution to illuminate small spaces like vitrines but also large areas, installing it like indirect lighting frames, that increase ceilings values. Ideal also to realize direct lightings in big halls, corridors and others.





INSTALLAZIONE CON CLIP IN POLICARBONATO SU SUPERFICIE ORIZZONTALE
INSTALLATION WITH POLYCARBONATE CLIP ON HORIZONTAL SURFACE

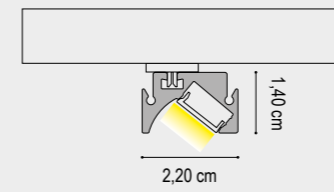

INSTALLAZIONE CON STAFFA MAGNETICA SU SUPERFICIE METALLICA ORIZZONTALE
INSTALLATION WITH MAGNET ON HORIZONTAL METAL SURFACE

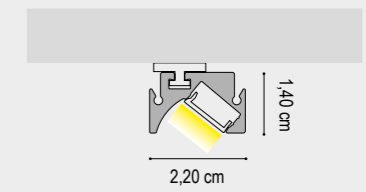

SI RACCOMANDA L'UTILIZZO DI N° 1 STAFFA MAGNETICA OGNI 25,00 cm DI PROFILO. TALE QUANTITÀ PUÒ VARIARE A SECONDA DELLA SUPERFICIE METALLICA DI INSTALLAZIONE.

WE RECOMMEND THE USE OF N° 1 MAGNETIC BRACKET EVERY 25.00 cm OF PROFILE. THIS QUANTITY MAY VARY DEPENDING ON THE METAL INSTALLATION SURFACE.

INSTALLAZIONE CON CLIP IN POLICARBONATO SU SUPERFICIE VERTICALE
INSTALLATION WITH POLYCARBONATE CLIP ON A VERTICAL SURFACE

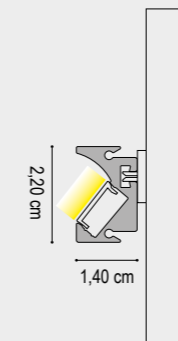

INSTALLAZIONE CON STAFFA MAGNETICA SU SUPERFICIE METALLICA VERTICALE
INSTALLATION WITH MAGNET ON VERTICAL METAL SURFACE

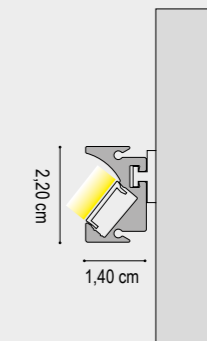

INSTALLAZIONE CON STAFFA PER INCASSO A CARTONGESSO
INSTALLATION WITH BRACKET FOR RECESSED PLASTERBOARD

ATTENZIONE! GLI ACCESSORI PER L'INSTALLAZIONE A INCASSO SONO STATI DIMENSIONATI PER UN PANNELLO STANDARD IN CARTONGESSO DI SPESSORE 12,5 mm
WARNING! THE BUILT-IN INSTALLATION ACCESSORIES HAVE BEEN DIMENSIONED FOR A STANDARD PLASTERBOARD PANEL OF 12.5 mm THICKNESS

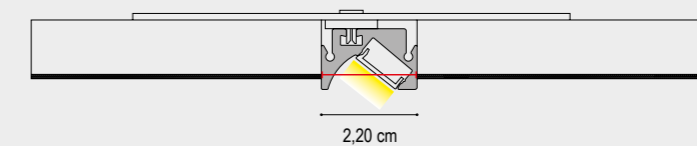

INSTALLAZIONE AD INCASSO
LARGHEZZA TAGLIO L=2,20cm
RECESSED INSTALLATION
CUTTING WIDTH L=3,50 cm

INSTALLAZIONE AD INCASSO CON CLIP NELLA MENSOLA
BUILT-IN INSTALLATION WITH SHELF IN POLYCARBONATE

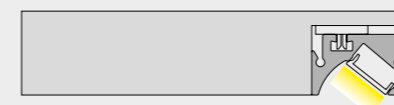

INSTALLAZIONE SEMI INCASSO CON CLIP NELLA MENSOLA
SEMI BUILT-IN INSTALLATION WITH SHELF

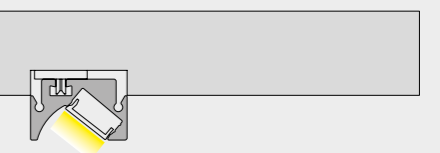

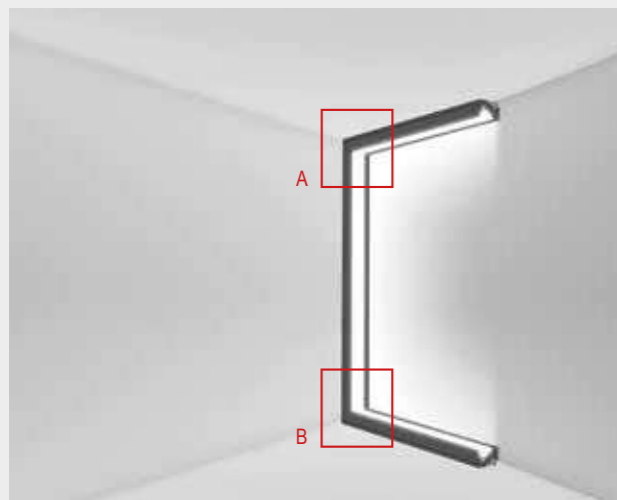

A) TAGLIO ANGOLARE - SOFFITTO/PARETE - TIPO A
 A) CORNER CUT - CEILING / WALL - TYPE A
 CODICE ARTICOLO / ITEM NUMBER: 190A

B) TAGLIO ANGOLARE - PARETE/SUP-ORIZZONTALE - TIPO B
 B) CORNER CUT - WALL / SUP-HORIZONTAL - TYPE B
 CODICE ARTICOLO / ITEM NUMBER: 190B

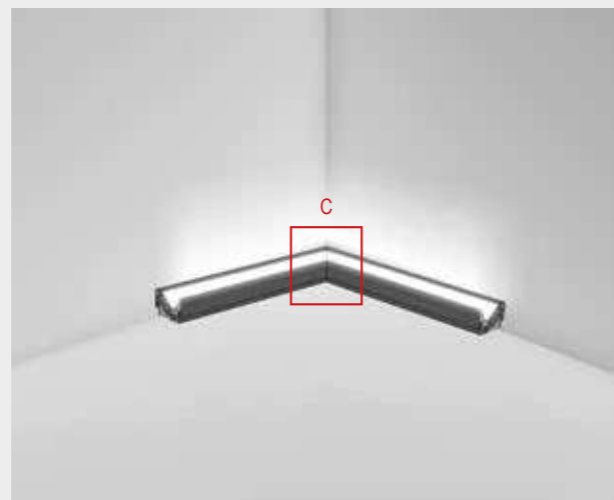

C) TAGLIO ANGOLARE - SUPERFICIE ORIZZONTALE - TIPO C
 C) CORNER CUT - HORIZONTAL SURFACE - TYPE C
 CODICE ARTICOLO / ITEM NUMBER: 190C



D) TAGLIO ANGOLARE - SUPERFICIE ORIZZONTALE - TIPO D
 D) CORNER CUT - HORIZONTAL SURFACE - TYPE D
 CODICE ARTICOLO / ITEM NUMBER: 190D



E) TAGLIO ANGOLARE - SUPERFICIE ORIZZONTALE - TIPO E
 E) CORNER CUT - HORIZONTAL SURFACE - TYPE E
 CODICE ARTICOLO / ITEM NUMBER: 190E

Ic014

led integrato

integrated led

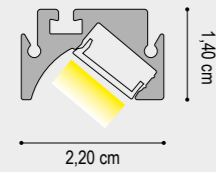
DATI TECNICI
 TECHNICAL DATA

	1 cm
Nominal LED Flux:	1200 lm/m
Flux Tot:	960 lm/m
Output:	85 lm/W
CCT:	3000 K
CRI:	>90
Power Tot:	14.4 W/m
Weight:	0.40 Kg/m

Profilo/Profile: Alluminio/aluminum
 Cover: Opale/opal

DRIVER NON INCLUSO / NOT INCLUDED

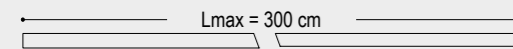
CAVO ALIMENTAZIONE: 50 cm
ALIMENTATION CABLE: 50 cm
FINITURA STRUTTURA
 FINISHES

GRIGIO VESUVIO ANTHRACITE
ARGILLA CLAY
ARGENTO OPACO/MATT SILVER
BIANCO INTONACO/WHITE
NERO CARAVAGGIO BLACK
MOKA MOCHA
CROMO/CHROME
ORO CALIFORNIA/GOLD
ARAMEN COPPER
ARGENTO COMETA/SILVER COMET
OTTONE VENEZIANO/BRASS
TITANIO/TITANIUM
BRONZO RIACI/RIACI BRONZE
VERDE COSTA/GREEN COAST
TERRA SENESE/SENESE EARTH

DIFFUSORE
 DIFFUSER

OPALE/OPAL

CODICE 2700K
 CODE 2700K

1050400001
1050401001
1050402001
1050403001
1050404001
1050405001
1050408001
1050409001
1050410001
1050412001
1050413001
1050414001
1050415001
1050416001
1050417001

1 cm

CODICE 3000K
 CODE 3000K

1050500001
1050501001
1050502001
1050503001
1050504001
1050505001
1050508001
1050509001
1050510001
1050512001
1050513001
1050514001
1050515001
1050516001
1050517001

CODICE 4000K
 CODE 4000K

1050600001
1050601001
1050602001
1050603001
1050604001
1050605001
1050608001
1050609001
1050610001
1050612001
1050613001
1050614001
1050615001
1050616001
1050617001

N.B./P.N.: LUNGHEZZA MASSIMA VERSIONE CROMO = 2,00 m / MAXIMUM LENGTH CHROME VERSION = 2.00 m
 TESTATE DI CHIUSURA NON INCLUSE / DEAD ENDS NOT INCLUDED



Ic014

led integrato

integrated led

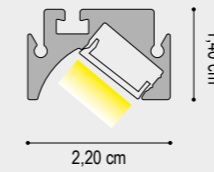
DATI TECNICI
 TECHNICAL DATA

	1 cm
Nominal LED Flux:	1600 lm/m
Flux Tot:	1280 lm/m
Output:	85 lm/W
CCT:	3000 K
CRI:	>90
Power Tot:	19.2 W/m
Weight:	0.40 Kg/m

Profilo/Profile: Alluminio/aluminum
 Cover: Opale/opal

DRIVER NON INCLUSO / NOT INCLUDED

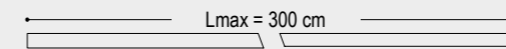
CAVO ALIMENTAZIONE: 50 cm
ALIMENTATION CABLE: 50 cm
FINITURA STRUTTURA
 FINISHES

GRIGIO VESUVIO ANTHRACITE
ARGILLA CLAY
ARGENTO OPACO/MATT SILVER
BIANCO INTONACO/WHITE
NERO CARAVAGGIO BLACK
MOKA MOCHA
CROMO/CHROME
ORO CALIFORNIA/GOLD
ARAMEN COPPER
ARGENTO COMETA/SILVER COMET
OTTONE VENEZIANO/BRASS
TITANIO/TITANIUM
BRONZO RIACI/RIACI BRONZE
VERDE COSTA/GREEN COAST
TERRA SENESE/SENESE EARTH

DIFFUSORE
 DIFFUSER

OPALE/OPAL

CODICE 2700K
 CODE 2700K

1050700001
1050701001
1050702001
1050703001
1050704001
1050705001
1050708001
1050709001
1050710001
1050712001
1050713001
1050714001
1050715001
1050716001
1050717001

1 cm

CODICE 3000K
 CODE 3000K

1050800001
1050801001
1050802001
1050803001
1050804001
1050805001
1050808001
1050809001
1050810001
1050812001
1050813001
1050814001
1050815001
1050816001
1050817001

CODICE 4000K
 CODE 4000K

1050900001
1050901001
1050902001
1050903001
1050904001
1050905001
1050908001
1050909001
1050910001
1050912001
1050913001
1050914001
1050915001
1050916001
1050917001

N.B./P.N.: LUNGHEZZA MASSIMA VERSIONE CROMO = 2,00 m / MAXIMUM LENGTH CHROME VERSION = 2.00 m
 TESTATE DI CHIUSURA NON INCLUSE / DEAD ENDS NOT INCLUDED



Ic014

led integrato

integrated led

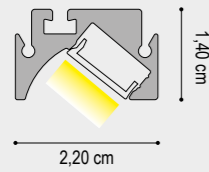
DATI TECNICI
TECHNICAL DATA

	1 cm
Nominal LED Flux:	1590 lm/m
Flux Tot:	1272 lm/m
Output:	110 lm/W
CCT:	3000 K
CRI:	>95
Power Tot:	14.4 W/m
Weight:	0.40 Kg/m

Profilo/Profile: Alluminio/aluminum
Cover: Opale/opal

DRIVER NON INCLUSO / NOT INCLUDED

CAVO ALIMENTAZIONE: 50 cm
ALIMENTATION CABLE: 50 cm

Lmax = 300 cm

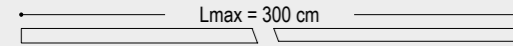
FINITURA STRUTTURA
FINISHES

GRIGIO VESUVIO ANTHRACITE
ARGILLA CLAY
ARGENTO OPACO/MATT SILVER
BIANCO INTONACO/WHITE
NERO CARAVAGGIO BLACK
MOKA MOCHA
CROMO/CHROME
ORO CALIFORNIA/GOLD
ARAMEN COPPER
ARGENTO COMETA/SILVER COMET
OTTONE VENEZIANO/BRASS
TITANIO/TITANIUM
BRONZO RIACI/RIACI BRONZE
VERDE COSTA/GREEN COAST
TERRA SENESE/SENESE EARTH

DIFFUSORE
DIFFUSER

OPALE/OPAL

CODICE 2700K
CODE 2700K

105G100001
105G101001
105G102001
105G103001
105G104001
105G105001
105G108001
105G109001
105G110001
105G112001
105G113001
105G114001
105G115001
105G116001
105G117001

1 cm

CODICE 3000K
CODE 3000K

105G201001
105G201001
105G202001
105G203001
105G204001
105G205001
105G208001
105G209001
105G210001
105G212001
105G213001
105G214001
105G215001
105G215001
105G217001

CODICE 4000K
CODE 4000K

105G301001
105G301001
105G302001
105G303001
105G304001
105G305001
105G208001
105G309001
105G310001
105G312001
105G313001
105G314001
105G315001
105G316001
105G317001

N.B./P.N.: LUNGHEZZA MASSIMA VERSIONE CROMO = 2,00 m / MAXIMUM LENGTH CHROME VERSION = 2.00 m
TESTATE DI CHIUSURA NON INCLUSE / DEAD ENDS NOT INCLUDED



Ic014

led integrato

integrated led

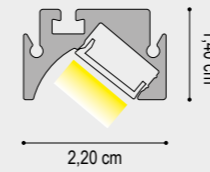
DATI TECNICI
TECHNICAL DATA

	1 cm
Nominal LED Flux:	2200 lm/m
Flux Tot:	1760 lm/m
Output:	110 lm/W
CCT:	3000 K
CRI:	>90
Power Tot:	20.0 W/m
Weight:	0.40 Kg/m

Profilo/Profile: Alluminio/aluminum
Cover: Opale/opal

DRIVER NON INCLUSO / NOT INCLUDED

CAVO ALIMENTAZIONE: 50 cm
ALIMENTATION CABLE: 50 cm

Lmax = 300 cm

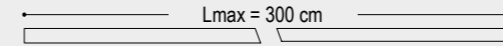
FINITURA STRUTTURA
FINISHES

GRIGIO VESUVIO ANTHRACITE
ARGILLA CLAY
ARGENTO OPACO/MATT SILVER
BIANCO INTONACO/WHITE
NERO CARAVAGGIO BLACK
MOKA MOCHA
CROMO/CHROME
ORO CALIFORNIA/GOLD
ARAMEN COPPER
ARGENTO COMETA/SILVER COMET
OTTONE VENEZIANO/BRASS
TITANIO/TITANIUM
BRONZO RIACI/RIACI BRONZE
VERDE COSTA/GREEN COAST
TERRA SENESE/SENESE EARTH

DIFFUSORE
DIFFUSER

OPALE/OPAL

CODICE 2700K
CODE 2700K

1054600001
1054601001
1054602001
1054603001
1054604001
1054605001
1054608001
1054609001
1054610001
1054612001
1054613001
1054614001
1054615001
1054616001
1054617001

1 cm

CODICE 3000K
CODE 3000K

1054700001
1054701001
1054702001
1054703001
1054704001
1054705001
1054708001
1054709001
1054710001
1054712001
1054713001
1054714001
1054715001
1054715001
1054717001

CODICE 4000K
CODE 4000K

1054800001
1054801001
1054802001
1054803001
1054804001
1054805001
1054808001
1054809001
1054810001
1054812001
1054813001
1054814001
1054815001
1054816001
1054817001

N.B./P.N.: LUNGHEZZA MASSIMA VERSIONE CROMO = 2,00 m / MAXIMUM LENGTH CHROME VERSION = 2.00 m
TESTATE DI CHIUSURA NON INCLUSE / DEAD ENDS NOT INCLUDED





Profilo in alluminio
Aluminium profile

Diffusore in policarbonato
Polycarbonate diffuser

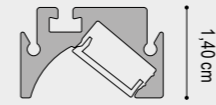

2,20 cm

1,40 cm

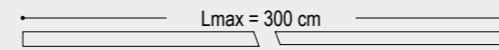

FINITURA STRUTTURA
FINISHES

- GRIGIO VESUVIO ANTHRACITE
- ARGILLA CLAY
- ARGENTO OPACO/MATT SILVER
- BIANCO INTONACO/WHITE
- NERO CARAVAGGIO/BLACK
- MOKA MOCHA
- ALLUMINIO NATURALE/ALUMINUM
- ORO CALIFORNIA/GOLD
- ARAMEN COPPER
- ARGENTO COMETA/SILVER COMET
- OTTONE VENEZIANO/BRASS
- TITANIO/TITANIUM
- BRONZO RIACI/RIACI BRONZE
- VERDE COSTA/GREEN COAST
- TERRA SENESE/SENESE EARTH
- CROMO/CHROME

DIFFUSORE
DIFFUSER

OPALE/OPAL

	1 cm	200 cm	300 cm
CODICE CODE	CODICE CODE	CODICE CODE	CODICE CODE
105CP00001	105CP00200	105CP00300	105CP00300
105CP01001	105CP01200	105CP01300	105CP01300
105CP02001	105CP02200	105CP02300	105CP02300
105CP03001	105CP03200	105CP03300	105CP03300
105CP04001	105CP04200	105CP04300	105CP04300
105CP05001	105CP05200	105CP05300	105CP05300
105CP06001	105CP06200	105CP06300	105CP06300
105CP09001	105CP09200	105CP09300	105CP09300
105CP10001	105CP10200	105CP10300	105CP10300
105CP12001	105CP12200	105CP12300	105CP12300
105CP13001	105CP13200	105CP13300	105CP13300
105CP14001	105CP14200	105CP14300	105CP14300
105CP15001	105CP15200	105CP15300	105CP15300
105CP16001	105CP16200	105CP16300	105CP16300
105CP17001	105CP17200	105CP17300	105CP17300
105CP08001	105CP08200		

N.B./P.N.: LUNGHEZZA MASSIMA VERSIONE CROMO = 2,00 m / MAXIMUM LENGTH CHROME VERSION = 2.00 m
TESTATE DI CHIUSURA NON INCLUDE / DEAD ENDS NOT INCLUDED

LED compatibili / LED compatibility

HIGH QUALITY CRI>90 CRI>95	HIGH OUTPUT CRI>90 CRI>95	HIGH EFFICIENT CRI>90 CRI>95	HIGH INTENSITY CRI>90 CRI>95	LOW POWER CRI>90	ULTRA SLIM CRI>90 CRI>95 CRI>97	RGB	RGB WHITE	RGB TW	TUNABLE WHITE
9,6W 14,4W 19,2W	12,3W 14,4W 19,2W 20W 24W	12,3W 14,4W 19,2W 20W 24W	24W 24W (700 LED)	6W	9,6W 12W 14,4W	14W	14W	14,4W 23W	19,2W



lc014

profilo e diffusore

profile and diffuser

lc014

profilo e diffusore

profile and diffuser

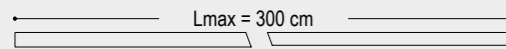
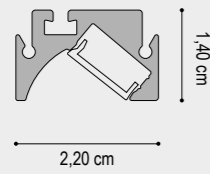

Profilo in alluminio
Aluminium profile

Diffusore in policarbonato
Polycarbonate diffuser

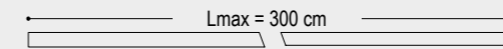
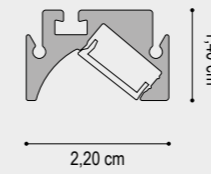

Profilo in alluminio
Aluminium profile

Diffusore in policarbonato
Polycarbonate diffuser

FINITURA STRUTTURA FINISHES	DIFFUSORE DIFFUSER	1 cm		200 cm		300 cm	
		CODICE CODE	PREZZO PRICE	CODICE CODE	PREZZO PRICE	CODICE CODE	PREZZO PRICE
GRIGIO VESUVIO ANTHRACITE	SATINATA/SATIN	105CS00001	€ 0,28	105CS00200	€ 47,80	105CS00300	€ 71,70
ARGILLA CLAY		105CS01001	€ 0,28	105CS01200	€ 47,80	105CS01300	€ 71,70
ARGENTO OPACO/MATT SILVER		105CS02001	€ 0,28	105CS02200	€ 47,80	105CS02300	€ 71,70
BIANCO INTONACO/WHITE		105CS03001	€ 0,28	105CS03200	€ 47,80	105CS03300	€ 71,70
NERO CARAVAGGIO/BLACK		105CS04001	€ 0,28	105CS04200	€ 47,80	105CS04300	€ 71,70
MOKA MOCHA		105CS05001	€ 0,28	105CS05200	€ 47,80	105CS05300	€ 71,70
ALLUMINIO NATURALE/ALUMINUM		105CS06001	€ 0,22	105CS06200	€ 37,80	105CS06300	€ 56,70
ORO CALIFORNIA/GOLD		105CS09001	€ 0,33	105CS09200	€ 59,60	105CS09300	€ 89,40
ARAMEN COPPER		105CS10001	€ 0,35	105CS10200	€ 64,20	105CS10300	€ 96,30
ARGENTO COMETA/SILVER COMET		105CS12001	€ 0,33	105CS12200	€ 59,60	105CS12300	€ 89,40
OTTONE VENEZIANO/BRASS		105CS13001	€ 0,33	105CS13200	€ 59,60	105CS13300	€ 89,40
TITANIO/TITANIUM		105CS14001	€ 0,33	105CS14200	€ 59,60	105CS14300	€ 89,40
BRONZO RIACI/RIACI BRONZE		105CS15001	€ 0,33	105CS15200	€ 59,60	105CS15300	€ 89,40
VERDE COSTA/GREEN COAST		105CS16001	€ 0,33	105CS16200	€ 59,60	105CS16300	€ 89,40
TERRA SENESE/SENESE EARTH		105CS17001	€ 0,28	105CS17200	€ 47,80	105CS17300	€ 71,70
CROMO/CHROME		105CS08001	€ 0,35	105CS08200	€ 64,20		

N.B./P.N.: LUNGHEZZA MASSIMA VERSIONE CROMO = 2,00 m / MAXIMUM LENGTH CHROME VERSION = 2.00 m
TESTATE DI CHIUSURA NON INCLUSE / DEAD ENDS NOT INCLUDED

FINITURA STRUTTURA FINISHES	DIFFUSORE DIFFUSER	1 cm		200 cm		300 cm	
		CODICE CODE	CODICE CODE	CODICE CODE	CODICE CODE		
GRIGIO VESUVIO ANTHRACITE	ECLISSI ECLIPSE	105CE00001	105CE00200	105CE00300			
ARGILLA CLAY		105CE01001	105CE01200	105CE01300			
ARGENTO OPACO/MATT SILVER		105CE02001	105CE02200	105CE02300			
BIANCO INTONACO/WHITE		105CE03001	105CE03200	105CE03300			
NERO CARAVAGGIO/BLACK		105CE04001	105CE04200	105CE04300			
MOKA MOCHA		105CE05001	105CE05200	105CE05300			
ALLUMINIO NATURALE/ALUMINUM		105CE06001	105CE06200	105CE06300			
ORO CALIFORNIA/GOLD		105CE09001	105CE09200	105CE09300			
ARAMEN COPPER		105CE10001	105CE10200	105CE10300			
ARGENTO COMETA/SILVER COMET		105CE12001	105CE12200	105CE12300			
OTTONE VENEZIANO/BRASS		105CE13001	105CE13200	105CE13300			
TITANIO/TITANIUM		105CE14001	105CE14200	105CE14300			
BRONZO RIACI/RIACI BRONZE		105CE15001	105CE15200	105CE15300			
VERDE COSTA/GREEN COAST		105CE16001	105CE16200	105CE16300			
TERRA SENESE/SENESE EARTH		105CE17001	105CE17200	105CE17300			
CROMO/CHROME		105CE08001	105CE08200				

N.B./P.N.: LUNGHEZZA MASSIMA VERSIONE CROMO = 2,00 m / MAXIMUM LENGTH CHROME VERSION = 2.00 m
TESTATE DI CHIUSURA NON INCLUSE / DEAD ENDS NOT INCLUDED

LED compatibili / LED compatibility

HIGH QUALITY CRI>90 CRI>95	HIGH OUTPUT CRI>90 CRI>95	HIGH EFFICIENT CRI>90 CRI>95	HIGH INTENSITY CRI>90 CRI>95	LOW POWER CRI>90	ULTRA SLIM CRI>90 CRI>95 CRI>97	RGB	RGB WHITE	RGB TW	TUNABLE WHITE
9,6W 14,4W 19,2W	12,3W 14,4W 19,2W 20W 24W	12,3W 14,4W 19,2W 20W 24W	24W 24W (700 LED)	6W	9,6W 12W 14,4W	14W	14W	14,4W 23W	19,2W

PROFILO LC014 CON DIFFUSORE
ECLISSI. SI RIDUCE L'ABBAGLIAMENTO
E L'EFFETTO PUNTINATO.

PROFILE LC014 WITH ECLIPSE
DIFFUSER. THE CLOTHING AND THE
SPOTTED EFFECT ARE REDUCED.



TESTATE DI CHIUSURA / DEAD ENDS

FINITURA STRUTTURA FINISHES	CODICE CODE	FINITURA STRUTTURA FINISHES	CODICE CODE
GRIGIO VESUVIO ANTHRACITE	1050400000	ORO CALIFORNIA GOLD	1050409000
ARGILLA CLAY	1050401000	ARAMEN COPPER	1050410000
ARGENTO OPACO MATT SILVER	1050402000	ARGENTO COMETA/SILVER COMET	1050412000
BIANCO INTONACO/WHITE	1050403000	OTTONE VENEZIANO BRASS	1050413000
NERO CARAVAGGIO BLACK	1050404000	TITANIO/TITANIUM	1050414000
MOKA MOCHA	1050405000	BRONZO RIACI/RIACI BRONZE	1050415000
ALLUMINIO NATURALE/ALUMINUM	1050406000	VERDE COSTA/GREEN COAST	1050416000
CROMO/CHROME	1050408000	TERRA SENESE SENESE EARTH	1050417000

Nel codice sono comprese le viti per il fissaggio delle testate al profilo. Il codice contiene n° 1 testate di chiusura. / The code includes the screws for fixing the heads to the profile. The code contains 1 closing warheads

GIUNTI / JOINTS

	FINITURA FINISHES	CODICE CODE
GIUNTO LINEA CONTINUA / STRAIGHT JOINT Accessorio per giunzioni meccaniche lineari Accessory for linear mechanical joints	ALLUMINIO NATURALE/ALUMINUM	1010500006
GIUNTO 90° ORIZZONTALE / HORIZONTAL JOINT 90° Accessorio per giunzioni meccaniche con angolo 90° Accessory for linear mechanical joints with 90° angle	ALLUMINIO NATURALE/ALUMINUM	1010500005
GIUNTO 90° VERTICALE / VERTICAL JOINT 90° Accessorio per giunzioni meccaniche con angolo 90° Accessory for linear mechanical joints with 90° angle	ALLUMINIO NATURALE/ALUMINUM	1010500007

Nel codice sono compresi i grani per il fissaggio del giunto
The code includes the grains for fixing the joint.

INTERRUTTORE DIMMERABILE+INSTALLAZIONE / DIMMABLE SWITCH+INSTALLATION

DATI TECNICI TECHNICAL DATA	FINITURA STRUTTURA FINISHES	CODICE CODE
Accessorio che consente l'accensione e lo spegnimento dei LED e, a seconda della pressione, la regolazione dell'intensità luminosa. Accessory that allows the switching on and off of the LEDs and, depending on the pressure, the regulation of the light intensity. Tensione di alimentazione: 12-24V DC Supply voltage: 12-24V DC Corrente d'uscita: 4A max Output current: 4A max ON / OFF: contact < 0.7 s DIMMER: contact > 0.7 s	ALLUMINIO NATURALE/ALUMINUM	98244

STAFFA DI FISSAGGIO / MOUNTING CLIP

FINITURA FINISHES	CODICE CODE
SUPERFICI PIANE 2mm EVEN SURFACE 2mm	1020500003
SUPERFICI IRREGOLARI 3,5mm UNEVEN SURFACE 3,5mm	1020500004

Accessorio per fissaggio a plafone/superficie. Quantità raccomandata: 1 pz ogni 50 cm di profilo
Ceiling/surface mounting accessory. Recommended quantity: 1 pc every 50 cm of profile

CALAMITA / MAGNET





CODICE CODE	PORTATA RANGE
1020500001	1 Kg
1020500210	2 Kg

Quantità raccomandata: 1 pz ogni 25cm di profilo
Recommended quantity: 1 pc every 25cm of profile

STAFFA SEMINCASSO PER CARTONGESSO / SEMI-BASED BRACKET FOR PLASTERBOARD

DATI TECNICI TECHNICAL DATA	FINITURA STRUTTURA FINISHES	CODICE CODE
ARTICOLI INCLUSI NEL CODICE ARTICLES INCLUDED IN THE CODE Clip di fissaggio in policarbonato 3mm Fixing clip in 3mm polycarbonate Viti per il fissaggio del profilo alla staffa Screws for fixing the profile to the bracket	ALLUMINIO NATURALE/ALUMINUM	1090500001

LAVORAZIONI / PROCESSING

DATI TECNICI TECHNICAL DATA	CODICE CODE
 TAGLIO ANGOLARE 90° (PER ANGOLI FORMATI DA DUE PROFILI) TIPO A 90 ° CORNER CUT (FOR CORNERS MADE OF TWO PROFILES) - TYPE A	190A
TAGLIO ANGOLARE 90° (PER ANGOLI FORMATI DA DUE PROFILI) TIPO B 90 ° CORNER CUT (FOR CORNERS MADE OF TWO PROFILES) - TYPE B	190B
TAGLIO ANGOLARE 90° (PER ANGOLI FORMATI DA DUE PROFILI) TIPO C 90 ° CORNER CUT (FOR CORNERS MADE OF TWO PROFILES) - TYPE C	190C
TAGLIO ANGOLARE 90° (PER ANGOLI FORMATI DA DUE PROFILI) TIPO D 90 ° CORNER CUT (FOR CORNERS MADE OF TWO PROFILES) - TYPE D	190D
TAGLIO ANGOLARE 90° (PER ANGOLI FORMATI DA DUE PROFILI) TIPO E 90 ° CORNER CUT (FOR CORNERS MADE OF TWO PROFILES) - TYPE E	190E
TAGLIO ANGOLARE CUSTOM (PER ANGOLI FORMATI DA DUE PROFILI) CUSTOM CORNER CUT (FOR CORNERS MADE OF TWO PROFILES)	190N
 ASOLA / SLOT	100A
FORO / HOLE	100F
 CABLAGGIO - COLLAUDO - CE AL CENTIMETRO INSTALLATION AND TESTING LED MODULE AT CENTIMETER	1051
 CONNETTORE MASCHIO/FEMMINA MALE/FEMALE CONNECTOR	98CFM
CONNETTORE MASCHIO/FEMMINA MONTATO NEL PRODOTTO MALE/FEMALE CONNECTOR FITTED IN THE PRODUCT	98MFM
 CAVO DI ALIMENTAZIONE 2X0,50 BIANCO 1CM POWER CABLE 2X0,50 WHITE 1CM	98CB001
CAVO DI ALIMENTAZIONE 2X0,50 NERO 1CM POWER CABLE 2X0,50 BLACK 1CM	98CN001

“prodotto estremamente versatile”

LC021 è il brillante risultato della nostra vocazione alla continua ricerca di soluzioni luminose che tendono a risolvere e soddisfare le esigenze illuminotecniche della nostra clientela. La finalità iniziale del nostro studio era quella di realizzare un prodotto estremamente versatile.

Il Design studiato per rendere possibile un'installazione da incasso, semi incasso o da parete. LC021 è la soluzione ideale per illuminare piccoli spazi come vetrine oppure ambienti più grandi usandolo anche come cornice luminosa a luce indiretta per valorizzare soffitti a volte oppure può essere utilizzata come luce diretta per illuminare sale, corridoi, ecc.

LC021 is the brilliant result of our vocation to the continuous search for lighting solutions that tend to solve and satisfy the lighting needs of our customers. The initial purpose of our study was to create an extremely versatile product. The Design studied to make a recessed, semi-recessed or wall-mounted installation possible. LC021 is the ideal solution to illuminate small spaces such as shop windows or larger environments, also using it as a luminous frame with indirect light to enhance vaulted ceilings or it can be used as direct light to illuminate halls, corridors, etc.





INSTALLAZIONE CON STAFFA PER INCASSO A CARTONGESSO
 INSTALLATION WITH BRACKET FOR RECESSED PLASTERBOARD

ATTENZIONE! IL PROFILO E GLI ACCESSORI SONO STATI DIMENSIONATI PER UN PANNELLO STANDARD IN CARTONGESSO DI SPESSORE 12,5 mm
 WARNING! PROFILE AND ACCESSORIES HAVE BEEN DIMENSIONED FOR A STANDARD PLASTERBOARD PANEL OF 12.5 mm THICKNESS

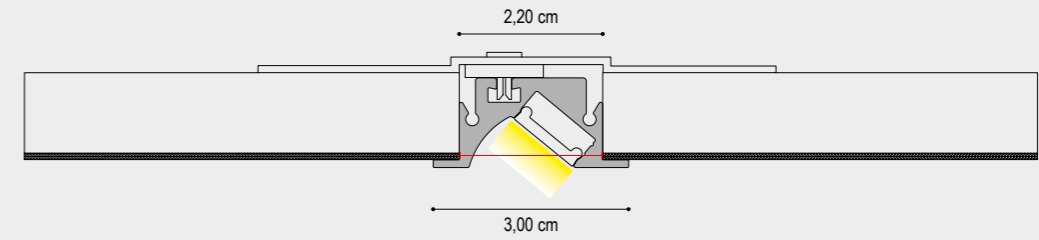

INSTALLAZIONE AD INCASSO
 LARGHEZZA TAGLIO L=2,20cm
 RECESSED INSTALLATION
 CUTTING WIDTH L=3,50 cm

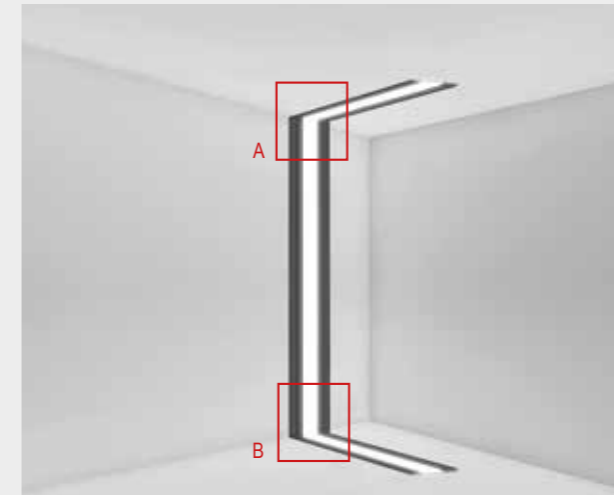

A) TAGLIO ANGOLARE - SOFFITTO/PARETE - TIPO A
 A) CORNER CUT - CEILING / WALL - TYPE A
 CODICE ARTICOLO / ITEM NUMBER: 190A

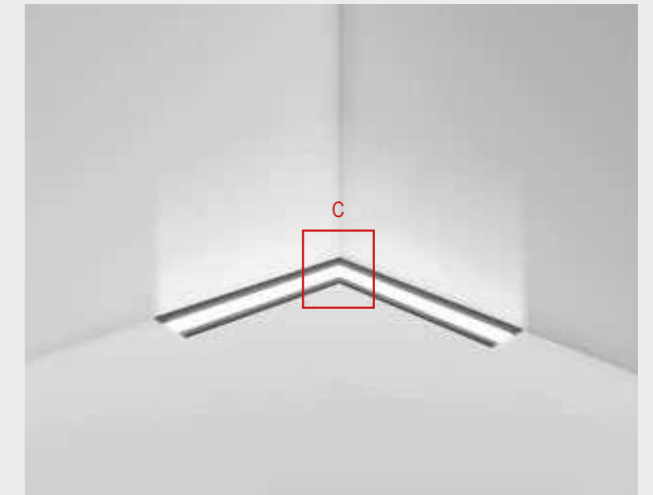

C) TAGLIO ANGOLARE - SUPERFICIE ORIZZONTALE - TIPO C
 C) CORNER CUT - HORIZONTAL SURFACE - TYPE C
 CODICE ARTICOLO / ITEM NUMBER: 190C

B) TAGLIO ANGOLARE - PARETE/SUP-ORIZZONTALE - TIPO B
 B) CORNER CUT - WALL / SUP-HORIZONTAL - TYPE B
 CODICE ARTICOLO / ITEM NUMBER: 190B

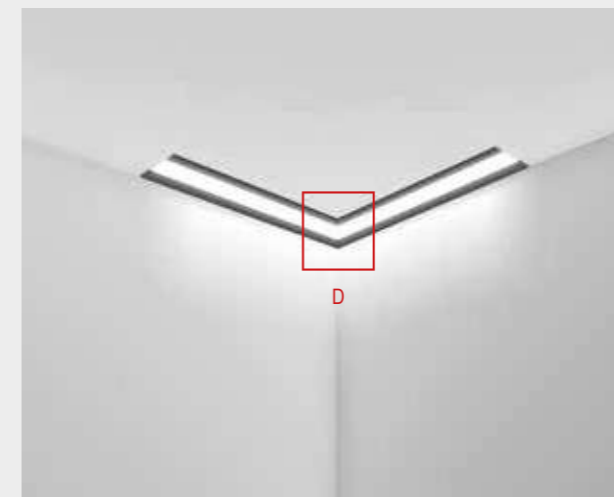

D) TAGLIO ANGOLARE - SUPERFICIE ORIZZONTALE - TIPO D
 D) CORNER CUT - HORIZONTAL SURFACE - TYPE D
 CODICE ARTICOLO / ITEM NUMBER: 190D

Ic021

led integrato

integrated led

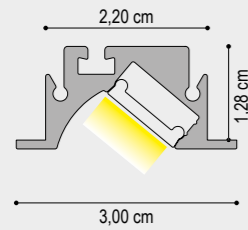
DATI TECNICI
TECHNICAL DATA

	1 cm
Nominal LED Flux:	1610 lm/m
Flux Tot:	1290 lm/m
Output:	135 lm/W
CCT:	3000 K
CRI:	>97 - R9>90
Power Tot:	12 W/m
Weight:	0.40 Kg/m

Profilo/Profile: Alluminio/aluminum
Cover: Opale/opal

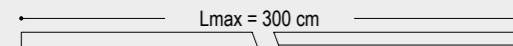

DRIVER NON INCLUSO / NOT INCLUDED

CAVO ALIMENTAZIONE: 50 cm
ALIMENTATION CABLE: 50 cm

1 cm

FINITURA STRUTTURA
FINISHES

GRIGIO VESUVIO ANTHRACITE
ARGILLA CLAY
ARGENTO OPACO/MATT SILVER
BIANCO INTONACO/WHITE
NERO CARAVAGGIO BLACK
MOKA MOCHA
CROMO/CHROME
ORO CALIFORNIA GOLD
ARAMEN COPPER
ARGENTO COMETA/SILVER COMET
OTTONE VENEZIANO BRASS
TITANIO/TITANIUM
BRONZO RIACI/RIACI BRONZE
VERDE COSTA/GREEN COAST
TERRA SENESE SENESE EARTH

DIFFUSORE
DIFFUSER

OPALE/OPAL

CODICE 2700K CODE 2700K
1496000001
1496010001
1496020001
1496030001
1496040001
1496050001
1496080001
1496090001
1496100001
1496120001
1496130001
1496140001
1496150001
1496160001
1496170001

CODICE 3000K CODE 3000K
1497000001
1497010001
1497020001
1497030001
1497040001
1497050001
1497080001
1497090001
1497100001
1497120001
1497130001
1497140001
1497150001
1497160001
1497170001

CODICE 4000K CODE 4000K
1498000001
1498010001
1498020001
1498030001
1498040001
1498050001
1498080001
1498090001
1498100001
1498120001
1498130001
1498140001
1498150001
1498160001
1498170001

N.B./P.N.: LUNGHEZZA MASSIMA VERSIONE CROMO = 2,00 m / MAXIMUM LENGTH CHROME VERSION = 2.00 m
TESTATE DI CHIUSURA NON INCLUSE / DEAD ENDS NOT INCLUDED



Ic021

led integrato

integrated led

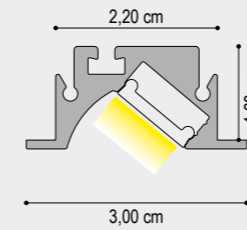
DATI TECNICI
TECHNICAL DATA

	1 cm
Nominal LED Flux:	1600 lm/m
Flux Tot:	1280 lm/m
Output:	85 lm/W
CCT:	3000 K
CRI:	>90
Power Tot:	19.2 W/m
Weight:	0.40 Kg/m

Profilo/Profile: Alluminio/aluminum
Cover: Opale/opal

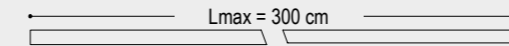

DRIVER NON INCLUSO / NOT INCLUDED

CAVO ALIMENTAZIONE: 50 cm
ALIMENTATION CABLE: 50 cm

1 cm

FINITURA STRUTTURA
FINISHES

GRIGIO VESUVIO ANTHRACITE
ARGILLA CLAY
ARGENTO OPACO/MATT SILVER
BIANCO INTONACO/WHITE
NERO CARAVAGGIO BLACK
MOKA MOCHA
CROMO/CHROME
ORO CALIFORNIA GOLD
ARAMEN COPPER
ARGENTO COMETA/SILVER COMET
OTTONE VENEZIANO BRASS
TITANIO/TITANIUM
BRONZO RIACI/RIACI BRONZE
VERDE COSTA/GREEN COAST
TERRA SENESE SENESE EARTH

DIFFUSORE
DIFFUSER

OPALE/OPAL

CODICE 2700K CODE 2700K
1407000001
1407010001
1407020001
1407030001
1407040001
1407050001
1407080001
1407090001
1407100001
1407120001
1407130001
1407140001
1407150001
1407160001
1407170001

CODICE 3000K CODE 3000K
1408000001
1408010001
1408020001
1408030001
1408040001
1408050001
1408080001
1408090001
1408100001
1408120001
1408130001
1408140001
1408150001
1408160001
1408170001

CODICE 4000K CODE 4000K
1409000001
1409010001
1409020001
1409030001
1409040001
1409050001
1409080001
1409090001
1409100001
1409120001
1409130001
1409140001
1409150001
1409160001
1409170001

N.B./P.N.: LUNGHEZZA MASSIMA VERSIONE CROMO = 2,00 m / MAXIMUM LENGTH CHROME VERSION = 2.00 m
TESTATE DI CHIUSURA NON INCLUSE / DEAD ENDS NOT INCLUDED



Ic021

profilo e diffusore

profile and diffuser

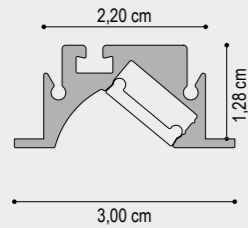

Profilo in alluminio
Aluminium profile

Diffusore in policarbonato
Polycarbonate diffuser

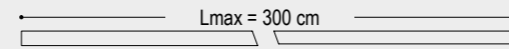

FINITURA STRUTTURA
FINISHES

GRIGIO VESUVIO ANTHRACITE
ARGILLA CLAY
ARGENTO OPACO/MATT SILVER
BIANCO INTONACO/WHITE
NERO CARAVAGGIO BLACK
MOKA MOCHA
ORO CALIFORNIA/GOLD
ARAMEN COPPER
ARGENTO COMETA/SILVER COMET
OTTONE VENEZIANO/BRASS
TITANIO/TITANIUM
BRONZO RIACI/RIACI BRONZE
VERDE COSTA/GREEN COAST
TERRA SENESE SENESE EARTH
CROMO/CHROME

DIFFUSORE
DIFFUSER

SATINATA/SATIN

	1 cm	200 cm	300 cm
CODICE CODE			
14CS00001	14CS000200	14CS000300	
14CS010001	14CS010200	14CS010300	
14CS020001	14CS020200	14CS020300	
14CS030001	14CS030200	14CS030300	
14CS040001	14CS040200	14CS040300	
14CS050001	14CS050200	14CS050300	
14CS090001	14CS090200	14CS090300	
14CS100001	14CS100200	14CS100300	
14CS120001	14CS120200	14CS120300	
14CS130001	14CS130200	14CS130300	
14CS140001	14CS140200	14CS140300	
14CS150001	14CS150200	14CS150300	
14CS160001	14CS160200	14CS160300	
14CS170001	14CS170200	14CS170300	
14CS080001	14CS080200		

N.B./P.N.: LUNGHEZZA MASSIMA VERSIONE CROMO = 2,00 m / MAXIMUM LENGTH CHROME VERSION = 2.00 m
TESTATE DI CHIUSURA NON INCLUSE / DEAD ENDS NOT INCLUDED

FINITURA STRUTTURA
FINISHES

GRIGIO VESUVIO ANTHRACITE
ARGILLA CLAY
ARGENTO OPACO/MATT SILVER
BIANCO INTONACO/WHITE
NERO CARAVAGGIO BLACK
MOKA MOCHA
ORO CALIFORNIA/GOLD
ARAMEN COPPER
ARGENTO COMETA/SILVER COMET
OTTONE VENEZIANO/BRASS
TITANIO/TITANIUM
BRONZO RIACI/RIACI BRONZE
VERDE COSTA/GREEN COAST
TERRA SENESE SENESE EARTH
CROMO/CHROME

DIFFUSORE
DIFFUSER

OPALE/OPAL

	1 cm	200 cm	300 cm
CODICE CODE			
14CP000001	14CP000200	14CP000300	
14CP010001	14CP010200	14CP010300	
14CP020001	14CP020200	14CP020300	
14CP030001	14CP030200	14CP030300	
14CP040001	14CP040200	14CP040300	
14CP050001	14CP050200	14CP050300	
14CP090001	14CP090200	14CP090300	
14CP100001	14CP100200	14CP100300	
14CP120001	14CP120200	14CP120300	
14CP130001	14CP130200	14CP130300	
14CP140001	14CP140200	14CP140300	
14CP150001	14CP150200	14CP150300	
14CP160001	14CP160200	14CP160300	
14CP170001	14CP170200	14CP170300	
14CP080001	14CP080200		

N.B./P.N.: LUNGHEZZA MASSIMA VERSIONE CROMO = 2,00 m / MAXIMUM LENGTH CHROME VERSION = 2.00 m
TESTATE DI CHIUSURA NON INCLUSE / DEAD ENDS NOT INCLUDED



Ic021

profilo e diffusore

profile and diffuser

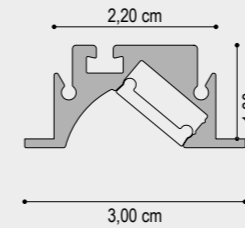

Profilo in alluminio
Aluminium profile

Diffusore in policarbonato
Polycarbonate diffuser

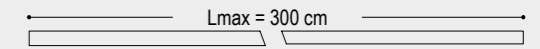

FINITURA STRUTTURA
FINISHES

GRIGIO VESUVIO ANTHRACITE
ARGILLA CLAY
ARGENTO OPACO/MATT SILVER
BIANCO INTONACO/WHITE
NERO CARAVAGGIO BLACK
MOKA MOCHA
ORO CALIFORNIA/GOLD
ARAMEN COPPER
ARGENTO COMETA/SILVER COMET
OTTONE VENEZIANO/BRASS
TITANIO/TITANIUM
BRONZO RIACI/RIACI BRONZE
VERDE COSTA/GREEN COAST
TERRA SENESE SENESE EARTH
CROMO/CHROME

DIFFUSORE
DIFFUSER

ECLISSI ECLIPSE

	1 cm	200 cm	300 cm
CODICE CODE			
14CE000001	14CE000200	14CE000300	
14CE010001	14CE010200	14CE010300	
14CE020001	14CE020200	14CE020300	
14CE030001	14CE030200	14CE030300	
14CE040001	14CE040200	14CE040300	
14CE050001	14CE050200	14CE050300	
14CE090001	14CE090200	14CE090300	
14CE100001	14CE100200	14CE100300	
14CE120001	14CE120200	14CE120300	
14CE130001	14CE130200	14CE130300	
14CE140001	14CE140200	14CE140300	
14CE150001	14CE150200	14CE150300	
14CE160001	14CE160200	14CE160300	
14CE170001	14CE170200	14CE170300	
14CE080001	14CE080200		

N.B./P.N.: LUNGHEZZA MASSIMA VERSIONE CROMO = 2,00 m / MAXIMUM LENGTH CHROME VERSION = 2.00 m
TESTATE DI CHIUSURA NON INCLUSE / DEAD ENDS NOT INCLUDED

LED compatibili / LED compatibility

HIGH QUALITY CRI>90 CRI>95	HIGH OUTPUT CRI>90 CRI>95	HIGH EFFICIENT CRI>90 CRI>95	HIGH INTENSITY CRI>90 CRI>95	LOW POWER CRI>90	ULTRA SLIM CRI>90 CRI>95 CRI>97	RGB	RGB WHITE	RGB TW	TUNABLE WHITE
9,6W 14,4W 19,2W	12,3W 14,4W 19,2W 20W 24W	12,3W 14,4W 19,2W 20W 24W	24W 24W (700 LED)	6W	9,6W 12W 14,4W	14W	14W	14,4W 23W	19,2W

TESTATE DI CHIUSURA / DEAD ENDS

FINITURA STRUTTURA FINISHES	CODICE CODE	FINITURA STRUTTURA FINISHES	CODICE CODE
GRIGIO VESUVIO ANTHRACITE	140400	ARAMEN COPPER	140410
ARGILLA CLAY	140401	ARGENTO COMETA/SILVER COMET	140412
ARGENTO OPACO/MATT SILVER	140402	OTTONE VENEZIANO/BRASS	140413
BIANCO INTONACO/WHITE	140403	TITANIO/TITANIUM	140414
NERO CARAVAGGIO BLACK	140404	BRONZO RIACI/RIACI BRONZE	140415
MOKA MOCHA	140405	VERDE COSTA/GREEN COAST	140416
CROMO/CHROME	140408	TERRA SENESE SENESE EARTH	140417
ORO CALIFORNIA/GOLD	140409		

Nel codice sono comprese le viti per il fissaggio delle testate al profilo. Il codice contiene n° 1 testate di chiusura. / The code includes the screws for fixing the heads to the profile. The code contains 1 closing warheads

INTERRUTTORE DIMMERABILE+INSTALLAZIONE / DIMMABLE SWITCH+INSTALLATION vedi pag. 646



“design minimalista dimensioni ridotte”

Il tema su cui si è svolto lo studio del progetto SC015 era quello di creare un prodotto in grado di direzionare la luce in maniera precisa e puntuale.

Il suo design estremamente minimalista le sue dimensioni ridottissime lo rendono un prodotto molto flessibile adatto ad essere posizionato in tutti gli angoli anche con dimensioni ridotte, questo ci permette di realizzare un segmento di Luce sia verticale che orizzontale ben distribuito ed omogeneo contribuendo ad esaltarne le scene espositive.

The idea to project SC015 is born with the need to have a profile which is able to direct the light precisely and punctually.

The design extremely minimal and dimensions very small, allows to have a very flexible installation and to put it also in very reduced angles.

Therefore offers the possibility to project a light segment vertically or horizontally with homogeneity effects directed on the expositive scenes.





INSTALLAZIONE SU SUPERFICI ORIZZONTALI E VERTICALI
INSTALLATION ON HORIZONTAL AND VERTICAL SURFACES

IL PRODOTTO SC015 NON PREVEDE ACCESSORI PER L'INSTALLAZIONE. IL FISSAGGIO A SUPERFICIE DEVE ESSERE REALIZZATO MEDIANTE APPOSITI COLLANTI O NASTRO BIADESIVO. SI RACCOMANDA DI SCEGLIERE IL METODO DI FISSAGGIO ADATTO ALLA SUPERFICIE DI INSTALLAZIONE.

THE SC015 PRODUCT DOES NOT PROVIDE ACCESSORIES FOR INSTALLATION. SURFACE MOUNTING MUST BE MADE USING SPECIAL ADHESIVES OR DOUBLE-SIDED TAPE. IT IS RECOMMENDED TO CHOOSE THE FASTENING METHOD SUITABLE FOR THE INSTALLATION SURFACE.

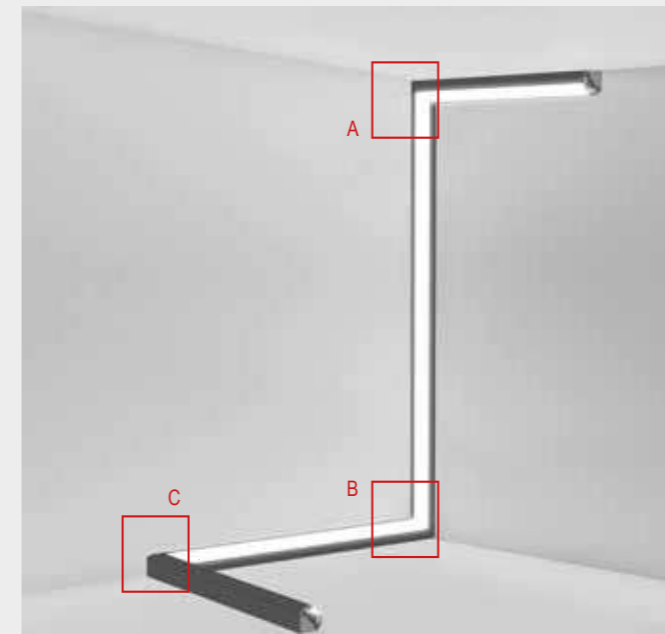
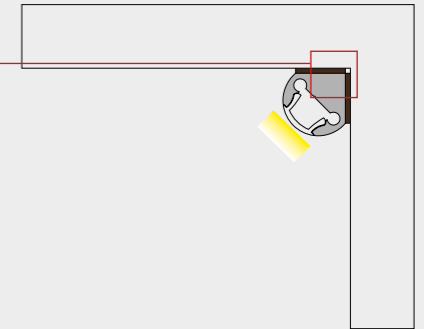

A) SUPERFICIE ORIZZONTALE / VERTICALER - ANGOLO 90° VERTICALE

A) HORIZONTAL / VERTICAL SURFACE - 90 ° VERTICAL ANGLE

CODICE ARTICOLO / ITEM NUMBER: 190Y

B) SUPERFICIE VERTICALE / ORIZZONTALE - ANGOLO 90° VERTICALE

B) VERTICAL / HORIZONTAL SURFACE - 90 ° VERTICAL ANGLE

CODICE ARTICOLO / ITEM NUMBER: 190Y

C) SUPERFICIE ORIZZONTALE - ANGOLO 90° ORIZZONTALE

C) HORIZONTAL SURFACE - 90 ° HORIZONTAL ANGLE

CODICE ARTICOLO / ITEM NUMBER: 190X

ANGOLO DIVERSO DA 90°
ANGLE DIFFERENT FROM 90 °

È POSSIBILE RICHIEDERE LA REALIZZAZIONE DI COMPOSIZIONI ANGOLARI CON ANGOLO DI AMPIEZZA DIVERSA DA 90°. OGNI RICHIESTA DEVE PERVENIRE AL NOSTRO REPARTO TECNICO CORREDATA DA SCHEMA ILLUSTRATIVO.

IT IS POSSIBLE TO REQUEST THE CREATION OF ANGULAR COMPOSITIONS WITH AN ANGLE OF DIFFERENT 90 °. EVERY REQUEST MUST COME TO OUR TECHNICAL DEPARTMENT WITH ILLUSTRATIVE DIAGRAM.



DATI TECNICI
TECHNICAL DATA

	1 cm
Nominal LED Flux:	1900 lm/m
Flux Tot:	1520 lm/m
Output:	158 lm/W
CCT:	3000 K
CRI:	>90
Power Tot:	12.0W/m
Weight:	0.20 Kg/m
Profilo/Profile: Alluminio/aluminum	
Cover: Opale/opal	



DATI TECNICI
TECHNICAL DATA

	1 cm
Nominal LED Flux:	1560 lm/m
Flux Tot:	1248 lm/m
Output:	130 lm/W
CCT:	3000 K
CRI:	>97 - R9>90
Power Tot:	12.0W/m
Weight:	0.20 Kg/m
Profilo/Profile: Alluminio/aluminum	
Cover: Opale/opal	

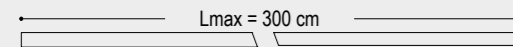

DRIVER NON INCLUSO / NOT INCLUDED

CAVO ALIMENTAZIONE: 50 cm
ALIMENTATION CABLE: 50 cm

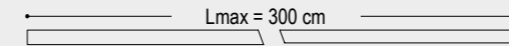

DRIVER NON INCLUSO / NOT INCLUDED

CAVO ALIMENTAZIONE: 50 cm
ALIMENTATION CABLE: 50 cm

FINITURA STRUTTURA
FINISHES

- GRIGIO VESUVIO ANTHRACITE
- ARGILLA CLAY
- ARGENTO OPACO/MATT SILVER
- BIANCO INTONACO/WHITE
- NERO CARAVAGGIO BLACK
- MOKA MOCHA
- CROMO/CHROME
- ORO CALIFORNIA GOLD
- ARAMEN COPPER
- ARGENTO COMETA/SILVER COMET
- OTTONE VENEZIANO/BRASS
- TITANIO/TITANIUM
- BRONZO RIACI/RIACI BRONZE
- VERDE COSTA/GREEN COAST
- TERRA SENESE SENESE EARTH

DIFFUSORE
DIFFUSER

OPALE/OPAL

CODICE 2700K CODE 2700K
1065400001
1065401001
1065402001
1065403001
1065404001
1065405001
1065409001
1065410001
1065412001
1065413001
1065414001
1065415001
1065416001
1065417001
1065408001

1 cm

CODICE 3000K CODE 3000K
1065500001
1065501001
1065502001
1065503001
1065504001
1065505001
1065509001
1065510001
1065512001
1065513001
1065514001
1065515001
1065516001
1065517001
1065508001

CODICE 4000K CODE 4000K
1065600001
1065601001
1065602001
1065603001
1065604001
1065605001
1065609001
1065610001
1065612001
1065613001
1065614001
1065615001
1065616001
1065617001
1065608001

N.B./P.N.: LUNGHEZZA MASSIMA VERSIONE CROMO = 2,00 m / MAXIMUM LENGTH CHROME VERSION = 2.00 m
TESTATE DI CHIUSURA NON INCLUSE / DEAD ENDS NOT INCLUDED

FINITURA STRUTTURA
FINISHES

- GRIGIO VESUVIO ANTHRACITE
- ARGILLA CLAY
- ARGENTO OPACO/MATT SILVER
- BIANCO INTONACO/WHITE
- NERO CARAVAGGIO BLACK
- MOKA MOCHA
- CROMO/CHROME
- ORO CALIFORNIA GOLD
- ARAMEN COPPER
- ARGENTO COMETA/SILVER COMET
- OTTONE VENEZIANO/BRASS
- TITANIO/TITANIUM
- BRONZO RIACI/RIACI BRONZE
- VERDE COSTA/GREEN COAST
- TERRA SENESE SENESE EARTH

DIFFUSORE
DIFFUSER

OPALE/OPAL

CODICE 2700K CODE 2700K
1069600001
1069601001
1069602001
1069603001
1069604001
1069605001
1069609001
1069610001
1069612001
1069613001
1069614001
1069615001
1069616001
1069617001
1069608001

1 cm

CODICE 3000K CODE 3000K
1069700001
1069701001
1069702001
1069703001
1069704001
1069705001
1069709001
1069710001
1069712001
1069713001
1069714001
1069715001
1069716001
1069717001
1069708001

CODICE 4000K CODE 4000K
1069800001
1069801001
1069802001
1069803001
1069804001
1069805001
1069809001
1069810001
1069812001
1069813001
1069814001
1069815001
1069816001
1069817001
1069808001

N.B./P.N.: LUNGHEZZA MASSIMA VERSIONE CROMO = 2,00 m / MAXIMUM LENGTH CHROME VERSION = 2.00 m
TESTATE DI CHIUSURA NON INCLUSE / DEAD ENDS NOT INCLUDED



Profilo in alluminio
Aluminium profile

Diffusore in policarbonato
Polycarbonate diffuser

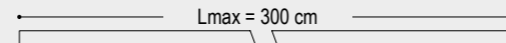

FINITURA STRUTTURA FINISHES	DIFFUSORE DIFFUSER	1 cm	200 cm	300 cm
		CODICE CODE	CODICE CODE	CODICE CODE
GRIGIO VESUVIO ANTHRACITE		106CP00001	106CP00200	106CP00300
ARGILLA CLAY		106CP01001	106CP01200	106CP01300
ARGENTO OPACO/MATT SILVER		106CP02001	106CP02200	106CP02300
BIANCO INTONACO/WHITE		106CP03001	106CP03200	106CP03300
NERO CARAVAGGIO BLACK		106CP04001	106CP04200	106CP04300
MOKA MOCHA		106CP05001	106CP05200	106CP05300
ORO CALIFORNIA/GOLD		106CP09001	106CP09200	106CP09300
ARAMEN COPPER	OPALE/OPAL	106CP10001	106CP10200	106CP10300
ARGENTO COMETA/SILVER COMET		106CP12001	106CP12200	106CP12300
OTTONE VENEZIANO BRASS		106CP13001	106CP13200	106CP13300
TITANIO/TITANIUM		106CP14001	106CP14200	106CP14300
BRONZO RIACI/RIACI BRONZE		106CP15001	106CP15200	106CP15300
VERDE COSTA/GREEN COAST		106CP16001	106CP16200	106CP16300
TERRA SENESE SENESE EARTH		106CP17001	106CP17200	106CP17300
CROMO/CHROME		106CP08001	106CP08200	

N.B./P.N.: LUNGHEZZA MASSIMA VERSIONE CROMO = 2,00 m / MAXIMUM LENGTH CHROME VERSION = 2.00 m
TESTATE DI CHIUSURA NON INCLUSE / DEAD ENDS NOT INCLUDED

LED compatibili / LED compatibility

HIGH QUALITY CRI>90 CRI>95	HIGH OUTPUT CRI>90 CRI>95	HIGH EFFICIENT CRI>90 CRI>95	HIGH INTENSITY CRI>90 CRI>95	LOW POWER CRI>90	ULTRA SLIM CRI>90 CRI>95 CRI>97	RGB	RGB WHITE	RGB TW	TUNABLE WHITE
✗	✗	✗	✗	✗	9,6W 12W 14,4W	✗	✗	✗	✗



TESTATE DI CHIUSURA / DEAD ENDS



FINITURA STRUTTURA FINISHES	CODICE CODE	FINITURA STRUTTURA FINISHES	CODICE CODE
GRIGIO VESUVIO ANTHRACITE	1060400000	ARAMEN COPPER	1060410000
ARGILLA CLAY	1060401000	ARGENTO COMETA/SILVER COMET	1060412000
ARGENTO OPACO/MATT SILVER	1060402000	OTTONE VENEZIANO BRASS	1060413000
BIANCO INTONACO/WHITE	1060403000	TITANIO/TITANIUM	1060414000
NERO CARAVAGGIO BLACK	1060404000	BRONZO RIACI/RIACI BRONZE	1060415000
MOKA MOCHA	1060405000	VERDE COSTA/GREEN COAST	1060416000
CROMO/CHROME	1060408000	TERRA SENESE SENESE EARTH	1060417000
ORO CALIFORNIA/GOLD	1060409000		

Nel codice sono comprese le viti per il fissaggio delle testate al profilo. Il codice contiene n° 1 testate di chiusura. / The code includes the screws for fixing the heads to the profile. The code contains 1 closing warheads

LAVORAZIONI / PROCESSING



DATI TECNICI TECHNICAL DATA	CODICE CODE
TAGLIO ANGOLARE 90° (PER ANGOLI FORMATI DA DUE PROFILI) TIPO A 90 ° CORNER CUT (FOR CORNERS MADE OF TWO PROFILES) - TYPE A	190A
TAGLIO ANGOLARE 90° (PER ANGOLI FORMATI DA DUE PROFILI) TIPO B 90 ° CORNER CUT (FOR CORNERS MADE OF TWO PROFILES) - TYPE B	190B
TAGLIO ANGOLARE 90° (PER ANGOLI FORMATI DA DUE PROFILI) TIPO C 90 ° CORNER CUT (FOR CORNERS MADE OF TWO PROFILES) - TYPE C	190C
TAGLIO ANGOLARE 90° (PER ANGOLI FORMATI DA DUE PROFILI) TIPO D 90 ° CORNER CUT (FOR CORNERS MADE OF TWO PROFILES) - TYPE D	190D
TAGLIO ANGOLARE 90° (PER ANGOLI FORMATI DA DUE PROFILI) TIPO E 90 ° CORNER CUT (FOR CORNERS MADE OF TWO PROFILES) - TYPE E	190E
TAGLIO ANGOLARE CUSTOM (PER ANGOLI FORMATI DA DUE PROFILI) CUSTOM CORNER CUT (FOR CORNERS MADE OF TWO PROFILES)	190N



ASOLA / SLOT	100A
FORO / HOLE	100F



CABLAGGIO - COLLAUDO - CE AL CENTIMETRO INSTALLATION AND TESTING LED MODULE AT CENTIMETER	1061
--	------



CONNETTORE MASCHIO/FEMMINA MALE/FEMALE CONNECTOR	98CFM
---	-------



CONNETTORE MASCHIO/FEMMINA MONTATO NEL PRODOTTO MALE/FEMALE CONNECTOR FITTED IN THE PRODUCT	98MFM
--	-------



CAVO DI ALIMENTAZIONE 2X0,50 BIANCO 1CM POWER CABLE 2X0,50 WHITE 1CM	98CB001
---	---------

CAVO DI ALIMENTAZIONE 2X0,50 NERO 1CM POWER CABLE 2X0,50 BLACK 1CM	98CN001
---	---------

“illumina vetrine, bacheche, mensole”

MS07 è il sistema di illuminazione più piccolo della famiglia Design Luce. Nonostante le ridotte dimensioni ha una linea unica abbinata ad un diffusore opale recesso che permette di direzionare il fascio luminoso. Può essere installato su qualsiasi superficie mediante appositi sistemi di fissaggio e con la sua sezione quadrata di soli 8,00 mm è particolarmente adatto per illuminare vetrine, bacheche, mensole.

MS07 is the smallest lighting system in the Design Luce family. Despite its small size it has a unique line combined with a recessed opal diffuser that allows to direct the light beam. It can be installed on any surface using special fastening systems and with its square section of only 8.00 mm it is particularly suitable for lighting display cases, showcases, shelves.



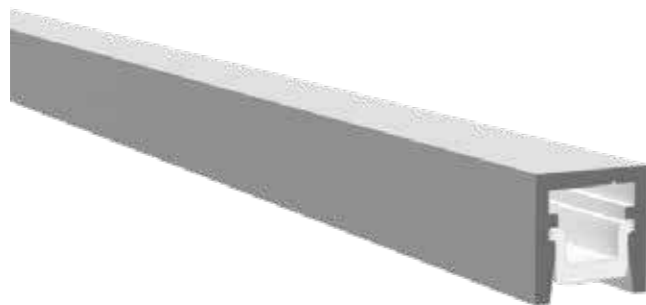

INSTALLAZIONE SU SUPERFICI ORIZZONTALI
INSTALLATION ON HORIZONTAL SURFACES

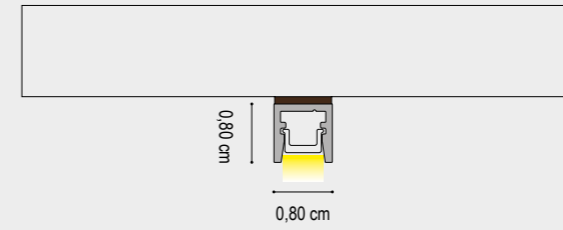

INSTALLAZIONE SU SUPERFICI VERTICALI
INSTALLATION ON VERTICAL SURFACES

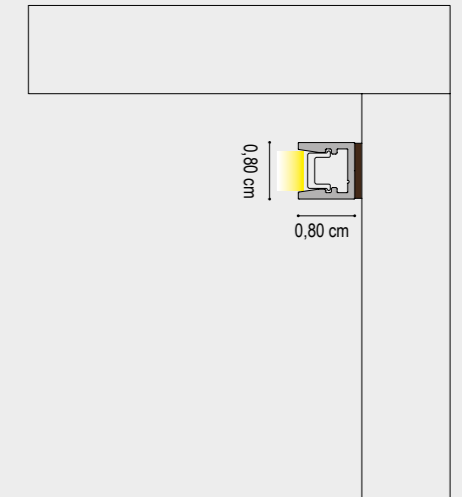

INSTALLAZIONE AD INCASSO
RECESSED INSTALLATION

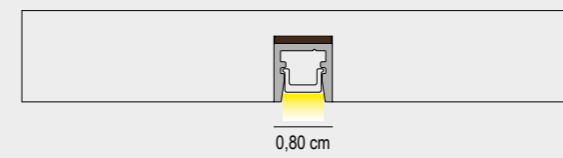

INSTALLAZIONE AD INCASSO
LARGHEZZA TAGLIO

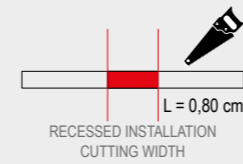

IL PRODOTTO MS07 NON PREVEDE ACCESSORI PER L'INSTALLAZIONE. IL FISSAGGIO DEVE ESSERE REALIZZATO MEDIANTE APOSITI COLLANTI O NASTRO BIADESIVO. SI RACCOMANDA DI SCEGLIERE IL METODO DI FISSAGGIO ADATTO ALLA SUPERFICIE DI INSTALLAZIONE.

THE MS07 PRODUCT DOES NOT PROVIDE ACCESSORIES FOR INSTALLATION. MOUNTING MUST BE MADE USING SPECIAL ADHESIVES OR DOUBLE-SIDED TAPE. IT IS RECOMMENDED TO CHOOSE THE FASTENING METHOD SUITABLE FOR THE INSTALLATION SURFACE.

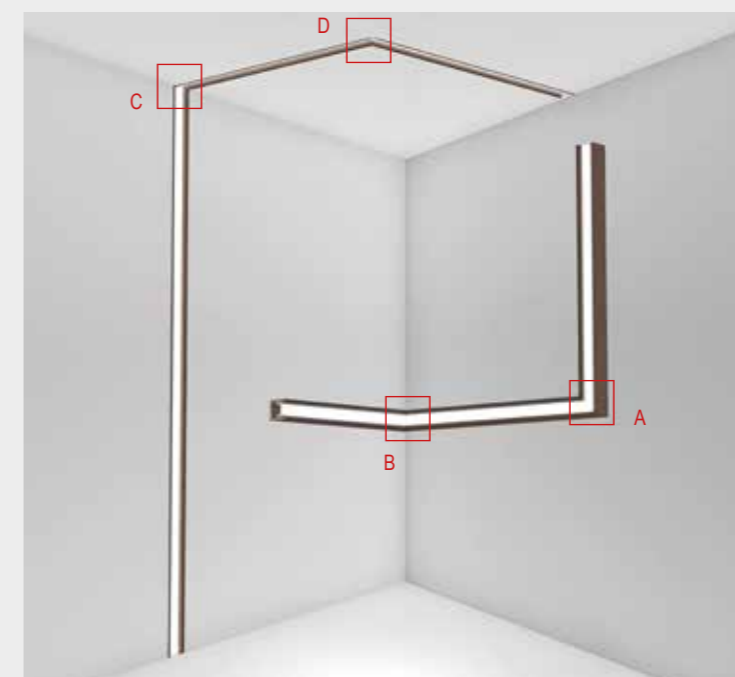

A) TAGLIO ANGOLARE - ANGOLO 90° ORIZZONTALE
A) CORNER CUT - HORIZONTAL 90° ANGLE
CODICE ARTICOLO / ITEM NUMBER: 190X

B) TAGLIO ANGOLARE - ANGOLO 90° VERTICALE
B) CORNER CUT - VERTICAL 90° ANGLE
CODICE ARTICOLO / ITEM NUMBER: 190Y

C) TAGLIO ANGOLARE - ANGOLO 90° VERTICALE
C) CORNER CUT - VERTICAL 90° ANGLE
CODICE ARTICOLO / ITEM NUMBER: 190Y

D) TAGLIO ANGOLARE - ANGOLO 90° ORIZZONTALE
D) CORNER CUT - HORIZONTAL 90° ANGLE
CODICE ARTICOLO / ITEM NUMBER: 190X

DATI TECNICI
TECHNICAL DATA

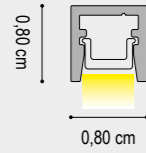

	1 cm
Nominal LED Flux:	1900 lm/m
Flux Tot:	1520 lm/m
Output:	158 lm/W
CCT:	3000 K
CRI:	>90
Power Tot:	12.0W/m
Weight:	0.15 Kg/m

Profilo/Profile: Alluminio/aluminum
Cover: Opale/opal

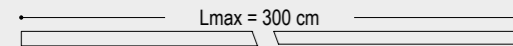

DRIVER NON INCLUSO / NOT INCLUDED

CAVO ALIMENTAZIONE: 50 cm
ALIMENTATION CABLE: 50 cm

1 cm

FINITURA STRUTTURA
FINISHES

- GRIGIO VESUVIO ANTHRACITE
- ARGILLA CLAY
- ARGENTO OPACO/MATT SILVER
- BIANCO INTONACO/WHITE
- NERO CARAVAGGIO BLACK
- MOKA MOCHA
- CROMO/CHROME
- ORO CALIFORNIA/GOLD
- ARAMEN COPPER
- ARGENTO COMETA/SILVER COMET
- OTTONE VENEZIANO BRASS
- TITANIO/TITANIUM
- BRONZO RIACI/RIACI BRONZE
- VERDE COSTA/GREEN COAST
- TERRA SENESE SENESE EARTH

DIFFUSORE
DIFFUSER

OPALE/OPAL

CODICE 2700K
CODE 2700K

- 1195400001
- 1195401001
- 1195402001
- 1195403001
- 1195404001
- 1195405001
- 1195408001
- 1195409001
- 1195410001
- 1195412001
- 1195413001
- 1195414001
- 1195415001
- 1195416001
- 1195417001

CODICE 3000K
CODE 3000K

- 1195500001
- 1195501001
- 1195502001
- 1195503001
- 1195504001
- 1195505001
- 1195508001
- 1195509001
- 1195510001
- 1195512001
- 1195513001
- 1195514001
- 1195515001
- 1195516001
- 1195517001

CODICE 4000K
CODE 4000K

- 1195600001
- 1195601001
- 1195602001
- 1195603001
- 1195604001
- 1195605001
- 1195608001
- 1195609001
- 1195610001
- 1195612001
- 1195613001
- 1195614001
- 1195615001
- 1195616001
- 1195617001

N.B./P.N.: LUNGHEZZA MASSIMA VERSIONE CROMO = 2,00 m / MAXIMUM LENGTH CHROME VERSION = 2.00 m
TESTATE DI CHIUSURA NON INCLUSE / DEAD ENDS NOT INCLUDED



DATI TECNICI
TECHNICAL DATA

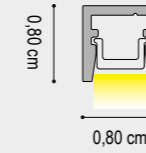

	1 cm
Nominal LED Flux:	1560 lm/m
Flux Tot:	1248 lm/m
Output:	130 lm/W
CCT:	3000 K
CRI:	>97 - R9>90
Power Tot:	12.0W/m
Weight:	0.15 Kg/m

Profilo/Profile: Alluminio/aluminum
Cover: Opale/opal

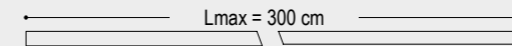

DRIVER NON INCLUSO / NOT INCLUDED

CAVO ALIMENTAZIONE: 50 cm
ALIMENTATION CABLE: 50 cm

1 cm

FINITURA STRUTTURA
FINISHES

- GRIGIO VESUVIO ANTHRACITE
- ARGILLA CLAY
- ARGENTO OPACO/MATT SILVER
- BIANCO INTONACO/WHITE
- NERO CARAVAGGIO BLACK
- MOKA MOCHA
- CROMO/CHROME
- ORO CALIFORNIA/GOLD
- ARAMEN COPPER
- ARGENTO COMETA/SILVER COMET
- OTTONE VENEZIANO BRASS
- TITANIO/TITANIUM
- BRONZO RIACI/RIACI BRONZE
- VERDE COSTA/GREEN COAST
- TERRA SENESE SENESE EARTH

DIFFUSORE
DIFFUSER

OPALE/OPAL

CODICE 2700K
CODE 2700K

- 1199600001
- 1199601001
- 1199602001
- 1199603001
- 1199604001
- 1199605001
- 1199608001
- 1199609001
- 1199610001
- 1199612001
- 1199613001
- 1199614001
- 1199615001
- 1199616001
- 1199617001

CODICE 3000K
CODE 3000K

- 1199700001
- 1199701001
- 1199702001
- 1199703001
- 1199704001
- 1199705001
- 1199708001
- 1199709001
- 1199710001
- 1199712001
- 1199713001
- 1199714001
- 1199715001
- 1199716001
- 1199717001

CODICE 4000K
CODE 4000K

- 1199800001
- 1199801001
- 1199802001
- 1199803001
- 1199804001
- 1199805001
- 1199808001
- 1199809001
- 1199810001
- 1199812001
- 1199813001
- 1199814001
- 1199815001
- 1199816001
- 1199817001

N.B./P.N.: LUNGHEZZA MASSIMA VERSIONE CROMO = 2,00 m / MAXIMUM LENGTH CHROME VERSION = 2.00 m
TESTATE DI CHIUSURA NON INCLUSE / DEAD ENDS NOT INCLUDED





TESTATE DI CHIUSURA / DEAD ENDS

FINITURA STRUTTURA FINISHES	CODICE CODE	FINITURA STRUTTURA FINISHES	CODICE CODE
GRIGIO VESUVIO/ANTHRACITE	1190400000	ARAMEN/COPPER	1190410000
ARGILLA/ARGIL	1190401000	ARGENTO COMETA/SILVER COMET	1190412000
ARGENTO OPACO/MATT SILVER	1190402000	OTTONE VENEZIANO/VENETIAN BRASS	1190413000
BIANCO INTONACO/WHITE	1190403000	TITANIO/TITANIUM	1190414000
NERO CARAVAGGIO/BLACK	1190404000	BRONZO RIACI/RIACI BRONZE	1190415000
MOKA/MOCHA	1190405000	VERDE COSTA/GREEN COAST	1190416000
CROMO/CHROME	1190408000	TERRA SENESE/SENESE EARTH	1190417000
ORO CALIFORNIA/GOLD	1190409000		

Nel codice sono comprese le viti per il fissaggio delle testate al profilo. Il codice contiene n° 1 testate di chiusura.
The code includes the screws for fixing the heads to the profile. The code contains 1 closing warheads

LAVORAZIONI / PROCESSING

DATI TECNICI TECHNICAL DATA	CODICE CODE
TAGLIO 90° ORIZZONTALE (PER ANGOLI FORMATI DA DUE PROFILI) HORIZONTAL 90 ° CUT (FOR CORNERS MADE OF TWO PROFILES)	190X
TAGLIO 90° VERTICALE (PER ANGOLI FORMATI DA DUE PROFILI) VERTICAL 90 ° CUT (FOR CORNERS MADE OF TWO PROFILES)	190Y
TAGLIO ANGOLARE CUSTOM (PER ANGOLI FORMATI DA DUE PROFILI) CUSTOM CORNER CUT (FOR CORNERS MADE OF TWO PROFILES)	190N
FORO / HOLE	100F
CAVO DI ALIMENTAZIONE 2X0,50 BIANCO 1CM POWER CABLE 2X0,50 WHITE 1CM	98CB001
CAVO DI ALIMENTAZIONE 2X0,50 NERO 1CM POWER CABLE 2X0,50 BLACK 1CM	98CN001

“ il profilo più piccolo mai progettato ”

MS08 è il secondo profilo più piccolo che la nostra azienda abbia mai progettato. Nasce dalla necessità di ridurre l'abbagliamento luminoso. Sappiamo che una buona luce senza abbagliamento contribuisce ad esaltare le forme e la qualità dei oggetti esposti in vetrine, bacheche e scaffalature. La sua forma innovativa in estruso d'alluminio le cui angolazioni sporgenti, rispetto al diffusore in policarbonato consentono di evidenziare le sue prospettive inoltre i tagli e i cablaggi personalizzati lo rendono estremamente flessibile.

MS08 is the second smallest profile that our company have ever projected. Designed for need to reduce the luminaire pollution and with a good light quality, on display objects in showcases, display cases and shelves, maintains forms and qualities. The innovative design in extruded aluminium with its protrude angles and the polycarbonate diff user emphasizes his own prospects. Customized length and diverse assembly solutions offer high flexibility.

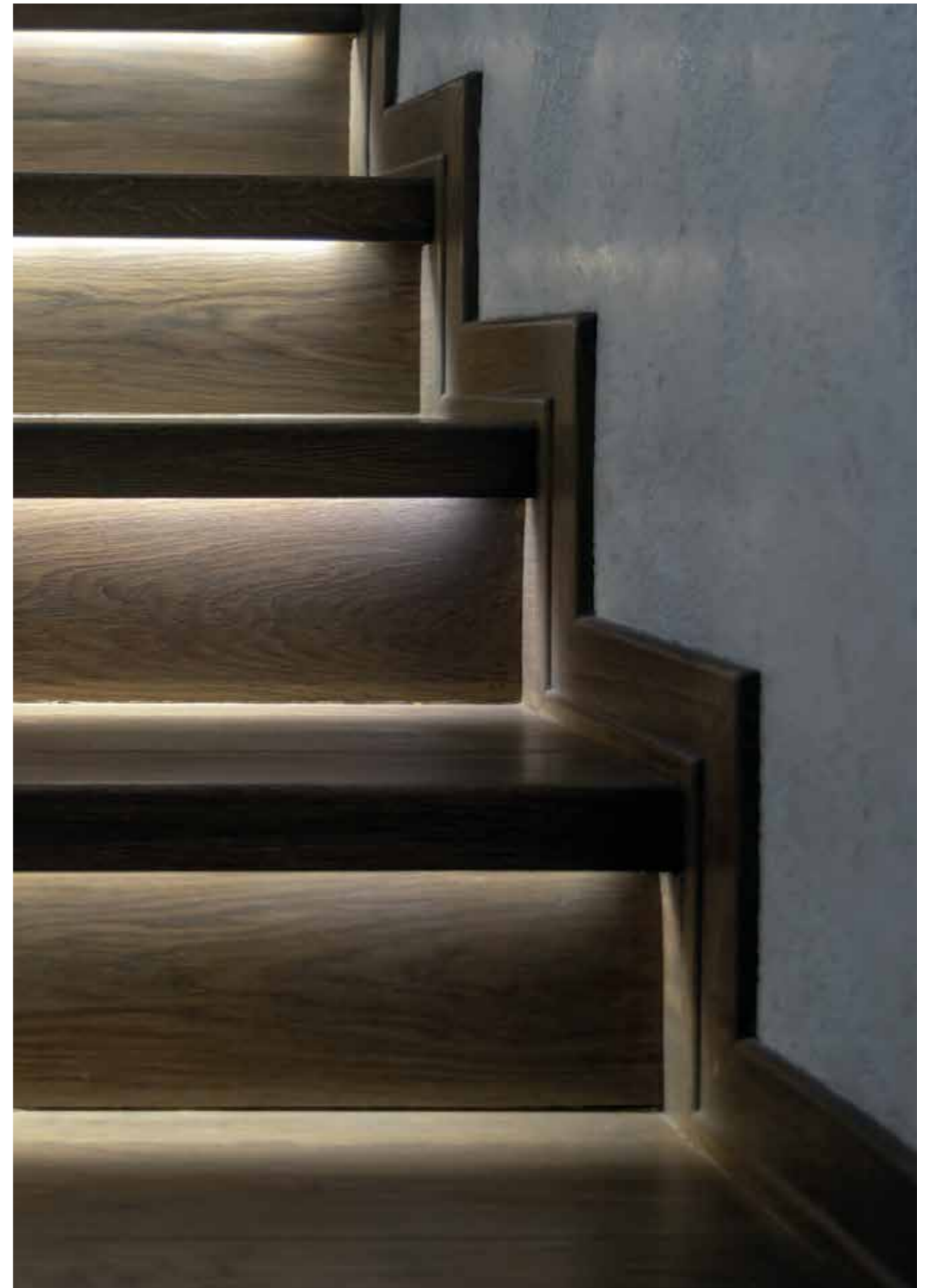

ms08

led integrato

integrated led

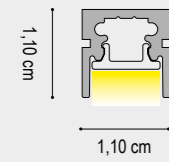

DATI TECNICI
TECHNICAL DATA

	1 cm
Nominal LED Flux:	1900 lm/m
Flux Tot:	1520 lm/m
Output:	158 lm/W
CCT:	3000 K
CRI:	>90
Power Tot:	12.0W/m
Weight:	0.30 Kg/m

Profilo/Profile: Alluminio/aluminum
Cover: Opale/opal

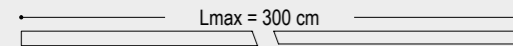

DRIVER NON INCLUSO / NOT INCLUDED

CAVO ALIMENTAZIONE: 50 cm
ALIMENTATION CABLE: 50 cm

ms08

led integrato

integrated led

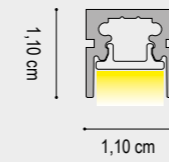

DATI TECNICI
TECHNICAL DATA

	1 cm
Nominal LED Flux:	1560 lm/m
Flux Tot:	1248 lm/m
Output:	130 lm/W
CCT:	3000 K
CRI:	>97 - R9>90
Power Tot:	12.0W/m
Weight:	0.30 Kg/m

Profilo/Profile: Alluminio/aluminum
Cover: Opale/opal

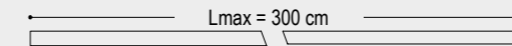

DRIVER NON INCLUSO / NOT INCLUDED

CAVO ALIMENTAZIONE: 50 cm
ALIMENTATION CABLE: 50 cm

FINITURA STRUTTURA
FINISHES

- GRIGIO VESUVIO ANTHRACITE
- ARGILLA CLAY
- ARGENTO OPACO/MATT SILVER
- BIANCO INTONACO/WHITE
- NERO CARAVAGGIO BLACK
- MOKA MOCHA
- CROMO/CHROME
- ORO CALIFORNIA/GOLD
- ARAMEN COPPER
- ARGENTO COMETA/SILVER COMET
- OTTONE VENEZIANO BRASS
- TITANIO/TITANIUM
- BRONZO RIACI/RIACI BRONZE
- VERDE COSTA/GREEN COAST
- TERRA SENESE SENESE EARTH

DIFFUSORE
DIFFUSER

OPALE/OPAL

	1 cm		
	CODICE 2700K CODE 2700K	CODICE 3000K CODE 3000K	CODICE 4000K CODE 4000K
1085400001	1085400001	1085500001	1085600001
1085401001	1085401001	1085501001	1085601001
1085402001	1085402001	1085502001	1085602001
1085403001	1085403001	1085503001	1085603001
1085404001	1085404001	1085504001	1085604001
1085405001	1085405001	1085505001	1085605001
1085408001	1085408001	1085508001	1085608001
1085409001	1085409001	1085509001	1085609001
1085410001	1085410001	1085510001	1085610001
1085412001	1085412001	1085512001	1085612001
1085413001	1085413001	1085513001	1085613001
1085414001	1085414001	1085514001	1085614001
1085415001	1085415001	1085515001	1085615001
1085416001	1085416001	1085516001	1085616001
1085417001	1085417001	1085517001	1085617001

N.B./P.N.: LUNGHEZZA MASSIMA VERSIONE CROMO = 2,00 m / MAXIMUM LENGTH CHROME VERSION = 2.00 m
TESTATE DI CHIUSURA NON INCLUSE / DEAD ENDS NOT INCLUDED

FINITURA STRUTTURA
FINISHES

- GRIGIO VESUVIO ANTHRACITE
- ARGILLA CLAY
- ARGENTO OPACO/MATT SILVER
- BIANCO INTONACO/WHITE
- NERO CARAVAGGIO BLACK
- MOKA MOCHA
- CROMO/CHROME
- ORO CALIFORNIA/GOLD
- ARAMEN COPPER
- ARGENTO COMETA/SILVER COMET
- OTTONE VENEZIANO BRASS
- TITANIO/TITANIUM
- BRONZO RIACI/RIACI BRONZE
- VERDE COSTA/GREEN COAST
- TERRA SENESE SENESE EARTH

DIFFUSORE
DIFFUSER

OPALE/OPAL

	1 cm		
	CODICE 2700K CODE 2700K	CODICE 3000K CODE 3000K	CODICE 4000K CODE 4000K
1089600001	1089600001	1089700001	1089800001
1089601001	1089601001	1089701001	1089801001
1089602001	1089602001	1089702001	1089802001
1089603001	1089603001	1089703001	1089803001
1089604001	1089604001	1089704001	1089804001
1089605001	1089605001	1089705001	1089805001
1089608001	1089608001	1089708001	1089808001
1089609001	1089609001	1089709001	1089809001
1089610001	1089610001	1089710001	1089810001
1089612001	1089612001	1089712001	1089812001
1089613001	1089613001	1089713001	1089813001
1089614001	1089614001	1089714001	1089814001
1089615001	1089615001	1089715001	1089815001
1089616001	1089616001	1089716001	1089816001
1089617001	1089617001	1089717001	1089817001

N.B./P.N.: LUNGHEZZA MASSIMA VERSIONE CROMO = 2,00 m / MAXIMUM LENGTH CHROME VERSION = 2.00 m
TESTATE DI CHIUSURA NON INCLUSE / DEAD ENDS NOT INCLUDED



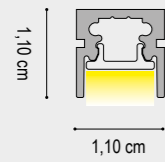

DATI TECNICI
TECHNICAL DATA

	1 cm
Nominal LED Flux:	1584 lm/m
Flux Tot:	1267 lm/m
Output:	110 lm/W
CCT:	3000 K
CRI:	>95
Power Tot:	14.4W/m
Weight:	0.30 Kg/m

Profilo/Profile: Alluminio/aluminum
Cover: Opale/opal

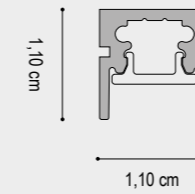

Profilo in alluminio
Aluminium profile

Diffusore in policarbonato
Polycarbonate diffuser

Lmax = 300 cm

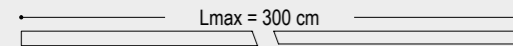

DRIVER NON INCLUSO / NOT INCLUDED

CAVO ALIMENTAZIONE: 50 cm
ALIMENTATION CABLE: 50 cm

FINITURA STRUTTURA
FINISHES

- GRIGIO VESUVIO ANTHRACITE
- ARGILLA CLAY
- ARGENTO OPACO/MATT SILVER
- BIANCO INTONACO/WHITE
- NERO CARAVAGGIO BLACK
- MOKA MOCHA
- CROMO/CHROME
- ORO CALIFORNIA/GOLD
- ARAMEN COPPER
- ARGENTO COMETA/SILVER COMET
- OTTONE VENEZIANO BRASS
- TITANIO/TITANIUM
- BRONZO RIACI/RIACI BRONZE
- VERDE COSTA/GREEN COAST
- TERRA SENESE SENESE EARTH

DIFFUSORE
DIFFUSER

OPALE/OPAL

	1 cm		
	CODICE 2700K CODE 2700K	CODICE 3000K CODE 3000K	CODICE 4000K CODE 4000K
108K10001	108K20001	108K30001	
108K10101	108K20101	108K30101	
108K10201	108K20201	108K30201	
108K10301	108K20301	108K30301	
108K10401	108K20401	108K30401	
108K10501	108K20501	108K30501	
108K10801	108K20801	108K30801	
108K10901	108K20901	108K30901	
108K11001	108K21001	108K31001	
108K11201	108K21201	108K31201	
108K11301	108K21301	108K31301	
108K11401	108K21401	108K31401	
108K11501	108K21501	108K31501	
108K11601	108K21601	108K31601	
108K11701	108K21701	108K31701	

N.B./P.N.: LUNGHEZZA MASSIMA VERSIONE CROMO = 2,00 m / MAXIMUM LENGTH CHROME VERSION = 2.00 m
TESTATE DI CHIUSURA NON INCLUSE / DEAD ENDS NOT INCLUDED

FINITURA STRUTTURA
FINISHES

- GRIGIO VESUVIO/ANTHRACITE
- ARGILLA/ARGIL
- ARGENTO OPACO/MATT SILVER
- BIANCO INTONACO/WHITE
- NERO CARAVAGGIO/BLACK
- MOKA/MOCHA
- ALLUMINIO NATURALE/ALUMINUM
- ORO CALIFORNIA/GOLD
- ARAMEN/COPPER
- ARGENTO COMETA/SILVER COMET
- OTTONE VENEZIANO/BRASS
- TITANIO/TITANIUM
- BRONZO RIACI/RIACI BRONZE
- VERDE COSTA/GREEN COAST
- TERRA SENESE/SENESE EARTH
- CROMO/CHROME

DIFFUSORE
DIFFUSER

OPALE/OPAL

	1 cm	200 cm	300 cm
	CODICE CODE	CODICE CODE	CODICE CODE
108CP00001	108CP00200	108CP00300	
108CP01001	108CP01200	108CP01300	
108CP02001	108CP02200	108CP02300	
108CP03001	108CP03200	108CP03300	
108CP04001	108CP04200	108CP04300	
108CP05001	108CP05200	108CP05300	
108CP06001	108CP06200	108CP06300	
108CP09001	108CP09200	108CP09300	
108CP10001	108CP10200	108CP10300	
108CP12001	108CP12200	108CP12300	
108CP13001	108CP13200	108CP13300	
108CP14001	108CP14200	108CP14300	
108CP15001	108CP15200	108CP15300	
108CP16001	108CP16200	108CP16300	
108CP17001	108CP17200	108CP17300	
108CP08001	108CP08200		

N.B./P.N.: LUNGHEZZA MASSIMA VERSIONE CROMO = 2,00 m / MAXIMUM LENGTH CHROME VERSION = 2.00 m
TESTATE DI CHIUSURA NON INCLUSE / DEAD ENDS NOT INCLUDED

LED compatibili / LED compatibility

HIGH QUALITY CRI>90 CRI>95	HIGH OUTPUT CRI>90 CRI>95	HIGH EFFICIENT CRI>90 CRI>95	HIGH INTENSITY CRI>90 CRI>95	LOW POWER CRI>90	ULTRA SLIM CRI>90 CRI>95 CRI>97	RGB	RGB WHITE	RGB TW	TUNABLE WHITE
✘	✘	✘	✘	✘	9,6W 12W 14,4W	✘	✘	✘	✘



TESTATE DI CHIUSURA / DEAD ENDS



FINITURA STRUTTURA FINISHES	CODICE CODE	FINITURA STRUTTURA FINISHES	CODICE CODE
GRIGIO VESUVIO/ANTHRACITE	108040000	ORO CALIFORNIA/GOLD	108040900
ARGILLA/ARGIL	108040100	ARAMEN/COPPER	108041000
ARGENTO OPACO/MATT SILVER	108040200	ARGENTO COMETA/SILVER COMET	108041200
BIANCO INTONACO/WHITE	108040300	OTTONE VENEZIANO/BRASS	108041300
NERO CARAVAGGIO/BLACK	108040400	TITANIO/TITANIUM	108041400
MOKA/MOCHA	108040500	BRONZO RIACI/RIACI BRONZE	108041500
ALLUMINIO NATURALE/ALUMINUM	108040600	VERDE COSTA/GREEN COAST	108041600
CROMO/CHROME	108040800	TERRA SENESE/SENESE EARTH	108041700

Nel codice sono comprese le viti per il fissaggio delle testate al profilo. Il codice contiene n° 1 testate di chiusura. / The code includes the screws for fixing the heads to the profile. The code contains 1 closing warheads

LAVORAZIONI / PROCESSING

DATI TECNICI TECHNICAL DATA	CODICE CODE
TAGLIO 90° ORIZZONTALE (PER ANGOLI FORMATI DA DUE PROFILI) HORIZONTAL 90 ° CUT (FOR CORNERS MADE OF TWO PROFILES)	190X
TAGLIO 90° VERTICALE (PER ANGOLI FORMATI DA DUE PROFILI) VERTICAL 90 ° CUT (FOR CORNERS MADE OF TWO PROFILES)	190Y
TAGLIO ANGOLARE CUSTOM (PER ANGOLI FORMATI DA DUE PROFILI) CUSTOM CORNER CUT (FOR CORNERS MADE OF TWO PROFILES)	190N
FORO / HOLE	100F
CABLAGGIO - COLLAUDO - CE AL CENTIMETRO INSTALLATION AND TESTING LED MODULE AT CENTIMETER	1081
CAVO DI ALIMENTAZIONE 2X0,50 BIANCO 1CM POWER CABLE 2X0,50 WHITE 1CM	98CB001
CAVO DI ALIMENTAZIONE 2X0,50 NERO 1CM POWER CABLE 2X0,50 BLACK 1CM	98CN001

“valorizza gli oggetti e gli ambienti”

MS09 è il più grande della famiglia MS; come gli altri contribuisce a ridurre l'abbagliamento e a valorizzare gli oggetti e gli ambienti. La sua forma innovativa in estruso d'alluminio le cui angolazioni sporgenti, rispetto al diffusore in policarbonato consentono di evidenziare le sue prospettive. I tagli e i cablaggi personalizzati lo rendono estremamente flessibile.

MS09 is the largest of the MS family; like the others, reduce glare and enhance objects and environments. Its innovative shape in extruded aluminum whose protruding angles, compared to the polycarbonate diffuser allow to highlight its perspectives. The custom cuts and wiring make it extremely flexible.

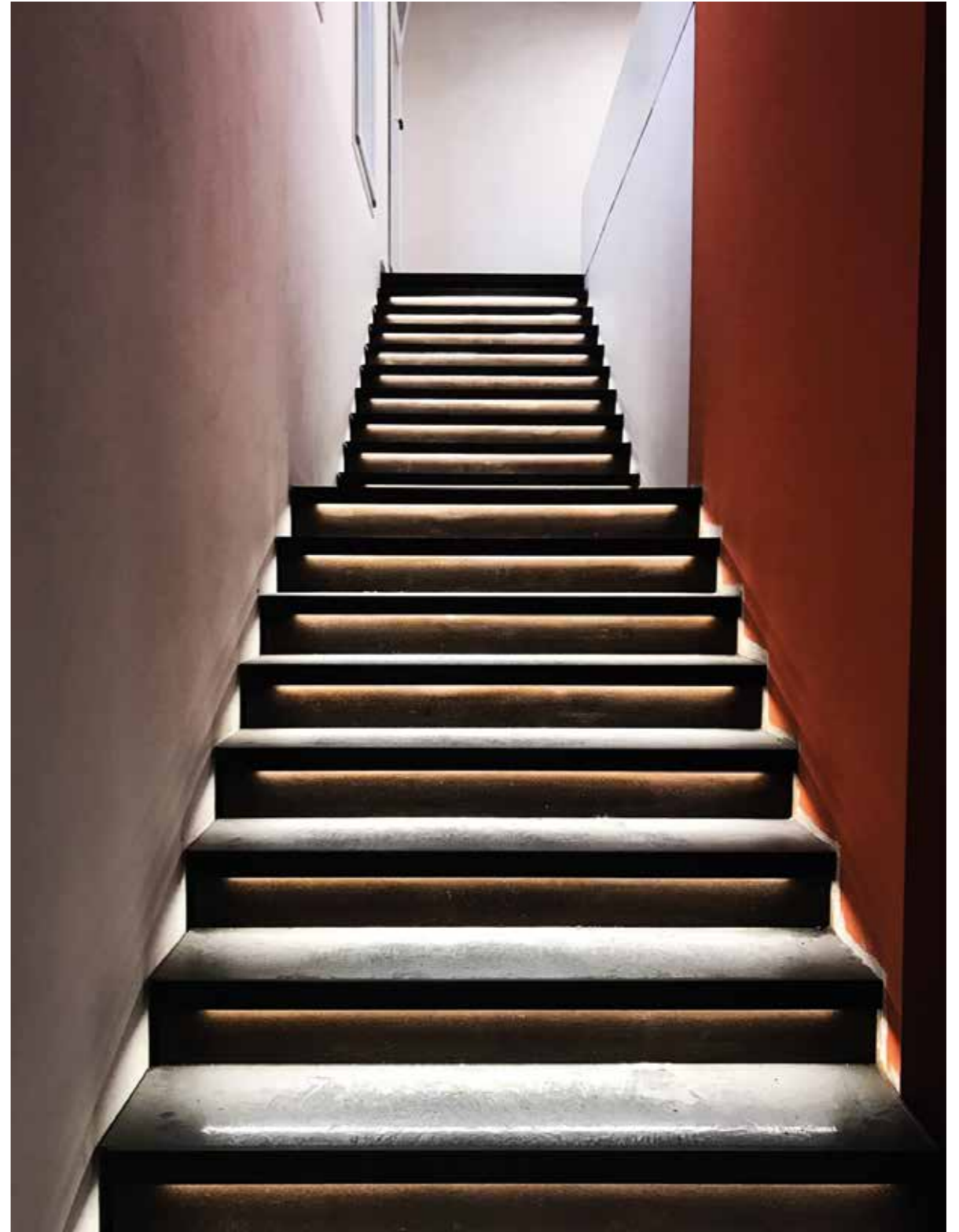

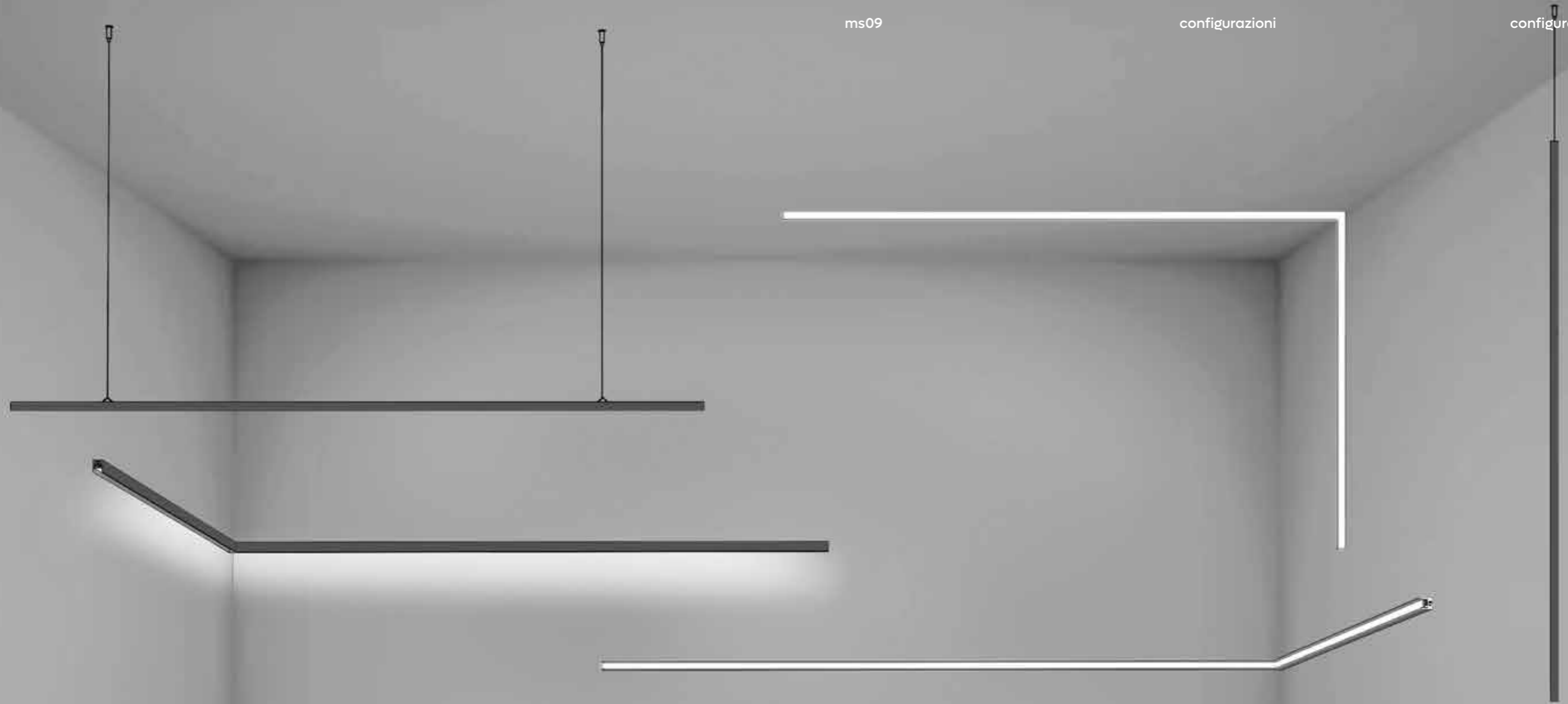

ATTENZIONE! GLI ACCESSORI PER L'INSTALLAZIONE A INCASSO SONO STATI DIMENSIONATI PER UN PANNELLO STANDARD IN CARTONGESSO DI SPESSORE 12,5 mm
 WARNING! THE BUILT-IN INSTALLATION ACCESSORIES HAVE BEEN DIMENSIONED FOR A STANDARD PLASTERBOARD PANEL OF 12.5 mm THICKNESS

INSTALLAZIONE A SOSPENSIONE
 SUSPENSION

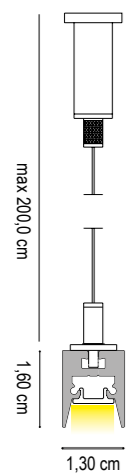

INSTALLAZIONE CON CLIP IN POLICARBONATO SU SUPERFICIE ORIZZONTALE
 INSTALLATION WITH POLYCARBONATE CLIP ON HORIZONTAL SURFACE

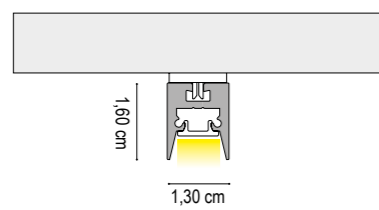

INSTALLAZIONE CON CALAMITA SU SUPERFICIE METALLICA ORIZZONTALE
 INSTALLATION WITH MAGNET ON HORIZONTAL METAL SURFACE

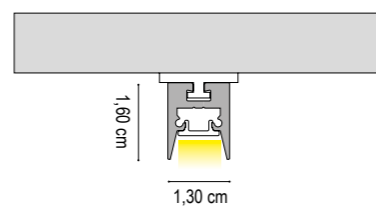

SI RACCOMANDA L'UTILIZZO DI N° 1 STAFFA MAGNETICA OGNI 25,00 cm DI PROFILO. TALE QUANTITÀ PUÒ VARIARE A SECONDA DELLA SUPERFICIE METALLICA DI INSTALLAZIONE.

WE RECOMMEND THE USE OF N° 1 MAGNETIC BRACKET EVERY 25.00 cm OF PROFILE. THIS QUANTITY MAY VARY DEPENDING ON THE METAL INSTALLATION SURFACE.

INSTALLAZIONE CON CLIP IN POLICARBONATO SU SUPERFICIE VERTICALE
 INSTALLATION WITH POLYCARBONATE CLIP ON A VERTICAL SURFACE

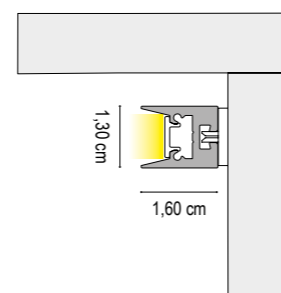

INSTALLAZIONE A PARETE
 WALL INSTALLATION

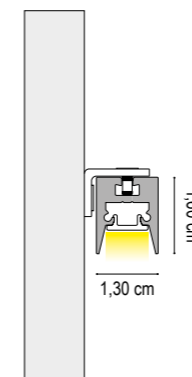

INSTALLAZIONE CON STAFFA PER INCASSO
 INSTALLATION WITH BUILT-IN BRACKET

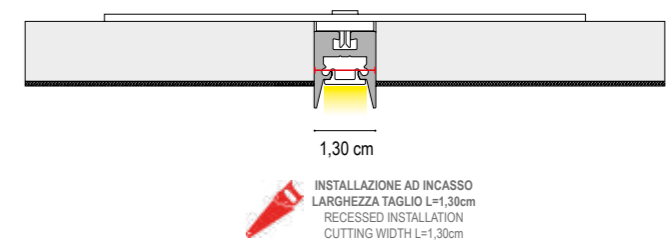

ms09

led integrato

integrated led

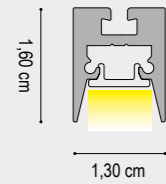

DATI TECNICI
TECHNICAL DATA

	1 cm
Nominal LED Flux:	1900 lm/m
Flux Tot:	1520 lm/m
Output:	158 lm/W
CCT:	3000 K
CRI:	>90
Power Tot:	12.0W/m
Weight:	0.60 Kg/m

Profilo/Profile: Alluminio/aluminum
Cover: Opale/opal

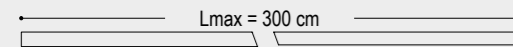

DRIVER NON INCLUSO / NOT INCLUDED

CAVO ALIMENTAZIONE: 50 cm
ALIMENTATION CABLE: 50 cm

1 cm

FINITURA STRUTTURA
FINISHES

- GRIGIO VESUVIO ANTHRACITE
- ARGILLA CLAY
- ARGENTO OPACO/MATT SILVER
- BIANCO INTONACO/WHITE
- NERO CARAVAGGIO BLACK
- MOKA MOCHA
- CROMO/CHROME
- ORO CALIFORNIA GOLD
- ARAMEN COPPER
- ARGENTO COMETA/SILVER COMET
- OTTONE VENEZIANO BRASS
- TITANIO/TITANIUM
- BRONZO RIACI/RIACI BRONZE
- VERDE COSTA/GREEN COAST
- TERRA SENESE SENESE EARTH

DIFFUSORE
DIFFUSER

OPALE/OPAL

CODICE 2700K CODE 2700K
1095400001
1095401001
1095402001
1095403001
1095404001
1095405001
1095408001
1095409001
1095410001
1095412001
1095413001
1095414001
1095415001
1095416001
1095417001

CODICE 3000K CODE 3000K
1095500001
1095501001
1095502001
1095503001
1095504001
1095505001
1095508001
1095509001
1095510001
1095512001
1095513001
1095514001
1095515001
1095516001
1095517001

CODICE 4000K CODE 4000K
1095600001
1095601001
1095602001
1095603001
1095604001
1095605001
1095608001
1095609001
1095610001
1095612001
1095613001
1095614001
1095615001
1095616001
1095617001

N.B./P.N.: LUNGHEZZA MASSIMA VERSIONE CROMO = 2,00 m / MAXIMUM LENGTH CHROME VERSION = 2.00 m
TESTATE DI CHIUSURA NON INCLUSE / DEAD ENDS NOT INCLUDED



ms09

led integrato

integrated led

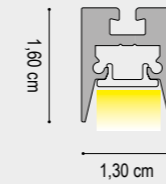

DATI TECNICI
TECHNICAL DATA

	1 cm
Nominal LED Flux:	1560 lm/m
Flux Tot:	1248 lm/m
Output:	130 lm/W
CCT:	3000 K
CRI:	>97 - R9>90
Power Tot:	12.0W/m
Weight:	0.60 Kg/m

Profilo/Profile: Alluminio/aluminum
Cover: Opale/opal

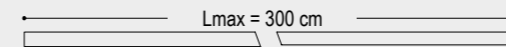

DRIVER NON INCLUSO / NOT INCLUDED

CAVO ALIMENTAZIONE: 50 cm
ALIMENTATION CABLE: 50 cm

1 cm

FINITURA STRUTTURA
FINISHES

- GRIGIO VESUVIO ANTHRACITE
- ARGILLA CLAY
- ARGENTO OPACO/MATT SILVER
- BIANCO INTONACO/WHITE
- NERO CARAVAGGIO BLACK
- MOKA MOCHA
- CROMO/CHROME
- ORO CALIFORNIA GOLD
- ARAMEN COPPER
- ARGENTO COMETA/SILVER COMET
- OTTONE VENEZIANO BRASS
- TITANIO/TITANIUM
- BRONZO RIACI/RIACI BRONZE
- VERDE COSTA/GREEN COAST
- TERRA SENESE SENESE EARTH

DIFFUSORE
DIFFUSER

OPALE/OPAL

CODICE 2700K CODE 2700K
1099600001
1099601001
1099602001
1099603001
1099604001
1099605001
1099608001
1099609001
1099610001
1099612001
1099613001
1099614001
1099615001
1099616001
1099617001

CODICE 3000K CODE 3000K
1099700001
1099701001
1099702001
1099703001
1099704001
1099705001
1099708001
1099709001
1099710001
1099712001
1099713001
1099714001
1099715001
1099716001
1099717001

CODICE 4000K CODE 4000K
1099800001
1099801001
1099802001
1099803001
1099804001
1099805001
1099808001
1099809001
1099810001
1099812001
1099813001
1099814001
1099815001
1099816001
1099817001

N.B./P.N.: LUNGHEZZA MASSIMA VERSIONE CROMO = 2,00 m / MAXIMUM LENGTH CHROME VERSION = 2.00 m
TESTATE DI CHIUSURA NON INCLUSE / DEAD ENDS NOT INCLUDED



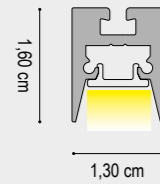

DATI TECNICI
TECHNICAL DATA

	1 cm
Nominal LED Flux:	1584 lm/m
Flux Tot:	1267 lm/m
Output:	110 lm/W
CCT:	3000 K
CRI:	>95
Power Tot:	14.4W/m
Weight:	0.60 Kg/m

Profilo/Profile: Alluminio/aluminum
Cover: Opale/opal

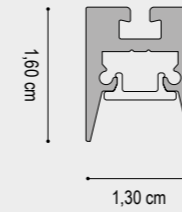

Profilo in alluminio
Aluminium profile

Diffusore in policarbonato
Polycarbonate diffuser

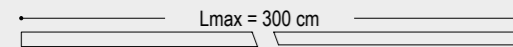

DRIVER NON INCLUSO / NOT INCLUDED

CAVO ALIMENTAZIONE: 50 cm
ALIMENTATION CABLE: 50 cm

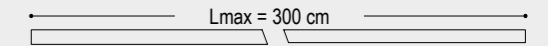

FINITURA STRUTTURA
FINISHES

- GRIGIO VESUVIO/ANTHRACITE
- ARGILLA CLAY
- ARGENTO OPACO/MATT SILVER
- BIANCO INTONACO/WHITE
- NERO CARAVAGGIO/BLACK
- MOKA MOCHA
- CROMO/CHROME
- ORO CALIFORNIA/GOLD
- ARAMEN COPPER
- ARGENTO COMETA/SILVER COMET
- OTTONE VENEZIANO/BRASS
- TITANIO/TITANIUM
- BRONZO RIACI/RIACI BRONZE
- VERDE COSTA/GREEN COAST
- TERRA SENESE/SENESE EARTH

DIFFUSORE
DIFFUSER

OPALE/OPAL

	1 cm		
	CODICE 2700K CODE 2700K	CODICE 3000K CODE 3000K	CODICE 4000K CODE 4000K
109K10001	109K20001	109K30001	
109K10101	109K20101	109K30101	
109K10201	109K20201	109K30201	
109K10301	109K20301	109K30301	
109K10401	109K20401	109K30401	
109K10501	109K20501	109K30501	
109K10901	109K20801	109K30801	
109K10901	109K20901	109K30901	
109K11001	109K21001	109K31001	
109K11201	109K21201	109K31201	
109K11301	109K21301	109K31301	
109K11401	109K21401	109K31401	
109K11501	109K21501	109K31501	
109K11601	109K21601	109K31601	
109K11701	109K21701	109K31701	

N.B./P.N.: LUNGHEZZA MASSIMA VERSIONE CROMO = 2,00 m / MAXIMUM LENGTH CHROME VERSION = 2.00 m
TESTATE DI CHIUSURA NON INCLUSE / DEAD ENDS NOT INCLUDED

FINITURA STRUTTURA
FINISHES

- GRIGIO VESUVIO/ANTHRACITE
- ARGILLA/ARGIL
- ARGENTO OPACO/MATT SILVER
- BIANCO INTONACO/WHITE
- NERO CARAVAGGIO/BLACK
- MOKA/MOCHA
- ORO CALIFORNIA/GOLD
- ARAMEN/COPPER
- ARGENTO COMETA/SILVER COMET
- OTTONE VENEZIANO/BRASS
- TITANIO/TITANIUM
- BRONZO RIACI/RIACI BRONZE
- VERDE COSTA/GREEN COAST
- TERRA SENESE/SENESE EARTH
- CROMO/CHROME

DIFFUSORE
DIFFUSER

OPALE/OPAL

	1 cm	200 cm	300 cm
	CODICE CODE	CODICE CODE	CODICE CODE
109CP00001	109CP00200	109CP00300	
109CP01001	109CP01200	109CP01300	
109CP02001	109CP02200	109CP02300	
109CP03001	109CP03200	109CP03300	
109CP04001	109CP04200	109CP04300	
109CP05001	109CP05200	109CP05300	
109CP09001	109CP09200	109CP09300	
109CP10001	109CP10200	109CP10300	
109CP12001	109CP12200	109CP12300	
109CP13001	109CP13200	109CP13300	
109CP14001	109CP14200	109CP14300	
109CP15001	109CP15200	109CP15300	
109CP16001	109CP16200	109CP16300	
109CP17001	109CP17200	109CP17300	
109CP08001	109CP08200		

N.B./P.N.: LUNGHEZZA MASSIMA VERSIONE CROMO = 2,00 m / MAXIMUM LENGTH CHROME VERSION = 2.00 m
TESTATE DI CHIUSURA NON INCLUSE / DEAD ENDS NOT INCLUDED

LED compatibili / LED compatibility

HIGH QUALITY CRI>90 CRI>95	HIGH OUTPUT CRI>90 CRI>95	HIGH EFFICIENT CRI>90 CRI>95	HIGH INTENSITY CRI>90 CRI>95	LOW POWER CRI>90	ULTRA SLIM CRI>90 CRI>95 CRI>97	RGB	RGB WHITE	RGB TW	TUNABLE WHITE
×	×	×	×	×	9,6W 12W 14,4W	×	×	×	×



TESTATE DI CHIUSURA / DEAD ENDS



FINITURA STRUTTURA FINISHES	CODICE CODE
GRIGIO VESUVIO/ANTHRACITE	1090400000
ARGILLA/ARGIL	1090401000
ARGENTO OPACO/MATT SILVER	1090402000
BIANCO INTONACO/WHITE	1090403000
NERO CARAVAGGIO/BLACK	1090404000
MOKA/MOCHA	1090405000
CROMO/CHROME	1090408000
ORO CALIFORNIA/GOLD	1090409000

FINITURA STRUTTURA FINISHES	CODICE CODE
ARAMEN/COPPER	1090410000
ARGENTO COMETA/SILVER COMET	1090412000
OTTONE VENEZIANO/BRASS	1090413000
TITANIO/TITANIUM	1090414000
BRONZO RIACI/RIACI BRONZE	1090415000
VERDE COSTA/GREEN COAST	1090416000
TERRA SENESE/SENESE EARTH	1090417000

Nel codice sono comprese le viti per il fissaggio delle testate al profilo. Il codice contiene n° 1 testate di chiusura. / The code includes the screws for fixing the heads to the profile. The code contains 1 closing warheads

STAFFA DI FISSAGGIO / MOUNTING CLIP



FINITURA FINISHES	CODICE CODE
SUPERFICI PIANE 2mm EVEN SURFACE 2mm	1020500003
SUPERFICI IRREGOLARI 3,5mm UNEVEN SURFACE 3,5mm	1020500004

Accessorio per fissaggio a plafone/superficie. Quantità raccomandata: 1 pz ogni 50 cm di profilo Ceiling/surface mounting accessory. Recommended quantity: 1 pc every 50 cm of profile

CALAMITA / MAGNET



CODICE CODE	PORTATA RANGE
102050001	1 Kg
1020500210	2 Kg

Quantità raccomandata: 1 pz ogni 25cm di profilo Recommended quantity: 1 pc every 25cm of profile

GIUNTI / JOINTS

GIUNTO LINEA CONTINUA / STRAIGHT JOINT

Accessorio per giunzioni meccaniche lineari
Accessory for linear mechanical joints

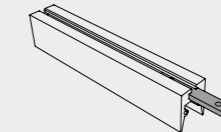

FINITURA FINISHES

ALLUMINIO NATURALE/ALUMINUM

CODICE CODE

1010500006

GIUNTO 90° ORIZZONTALE / HORIZONTAL JOINT 90°

Accessorio per giunzioni meccaniche con angolo 90°
Accessory for linear mechanical joints with 90° angle

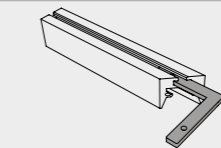

ALLUMINIO NATURALE/ALUMINUM

1010500005

GIUNTO 90° VERTICALE / VERTICAL JOINT 90°

Accessorio per giunzioni meccaniche con angolo 90°
Accessory for linear mechanical joints with 90° angle

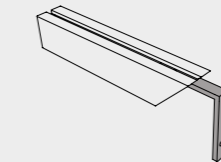

ALLUMINIO NATURALE/ALUMINUM

1010500007

Nel codice sono compresi i grani per il fissaggio del giunto
The code includes the grains for fixing the joint.

STAFFA INCASSO PER CARTONGESSO / SEMI-BASED BRACKET FOR PLASTERBOARD

DATI TECNICI
TECHNICAL DATA

ARTICOLI INCLUSI NEL CODICE
ARTICLES INCLUDED IN THE CODE

Clip di fissaggio in policarbonato 3mm
Fixing clip in 3mm polycarbonate
Viti per il fissaggio del profilo alla staffa
Screws for fixing the profile to the bracket

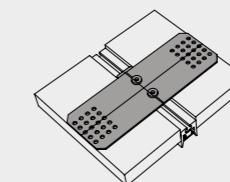

FINITURA STRUTTURA FINISHES

ALLUMINIO NATURALE/ALUMINUM

CODICE CODE

1090500001

KIT DI SOSPENSIONE / SUSPENSION KIT

DATI TECNICI
TECHNICAL DATAARTICOLI INCLUSI NEL CODICE
ARTICLES INCLUDED IN THE CODE

Cavo in acciaio 2,00m con puntalino
2.00m steel cable with tip
Boccola cromata con regolazione millimetrica
Chrome bush with millimeter adjustment
Archetto in alluminio per sospensione
Aluminum arch for suspension

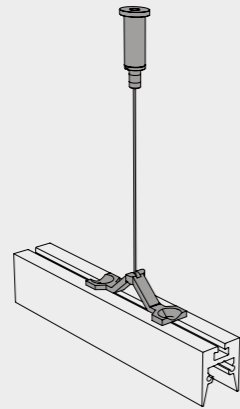
FINITURA STRUTTURA
FINISHES

GRIGIO VESUVIO/ANTHRACITE
ARGILLA/ARGIL
ARGENTO OPACO/MATT SILVER
BIANCO INTONACO/WHITE
NERO CARAVAGGIO/BLACK
MOKA/MOCHA
CROMO/CHROME
ORO CALIFORNIA/GOLD
ARAMEN/COPPER
ARGENTO COMETA/SILVER COMET
OTTONE VENEZIANO/BRASS
TITANIO/TITANIUM
BRONZO RIACI/RIACI BRONZE
VERDE COSTA/GREEN COAST
TERRA SENESE/SENESE EARTH

CODICE
CODE

1040500004
1040501004
1040502004
1040503004
1040504004
1040505004
1040508004
1040509004
1040510004
1030712004
1030713004
1090714004
1090715004
1090716004
1040517004

LAVORAZIONI / PROCESSING

DATI TECNICI
TECHNICAL DATA

TAGLIO 90° ORIZZONTALE (PER ANGOLI FORMATI DA DUE PROFILI)
HORIZONTAL 90 ° CUT (FOR CORNERS MADE OF TWO PROFILES)

TAGLIO 90° VERTICALE (PER ANGOLI FORMATI DA DUE PROFILI)
VERTICAL 90 ° CUT (FOR CORNERS MADE OF TWO PROFILES)

TAGLIO ANGOLARE CUSTOM (PER ANGOLI FORMATI DA DUE PROFILI)
CUSTOM CORNER CUT (FOR CORNERS MADE OF TWO PROFILES)

FORO / HOLE

CABLAGGIO - COLLAUDO - CE AL CENTIMETRO
INSTALLATION AND TESTING LED MODULE AT CENTIMETER

CAVO DI ALIMENTAZIONE 2X0,50 BIANCO 1CM
POWER CABLE 2X0,50 WHITE 1CM

CAVO DI ALIMENTAZIONE 2X0,50 NERO 1CM
POWER CABLE 2X0,50 BLACK 1CM

CODICE
CODE

190X
190Y
190N
100F
1091
98CB001
98CN001

STAFFA DI FISSAGGIO A PARETE / WALL MOUNTING CLIP

DATI TECNICI
TECHNICAL DATA

MATERIALE: Alluminio naturale
MATERIAL: Natural aluminum

Nel codice è compresa la vite per il fissaggio della staffa al profilo
The code includes the screw for fixing the bracket to the profile

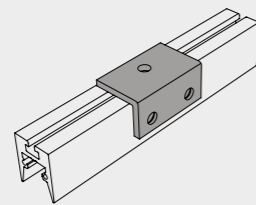
FINITURA STRUTTURA
FINISHES

GRIGIO VESUVIO/ANTHRACITE
ARGILLA/ARGIL
ARGENTO OPACO/MATT SILVER
BIANCO INTONACO/WHITE
NERO CARAVAGGIO/BLACK
MOKA/MOCHA
ORO CALIFORNIA/GOLD
ARAMEN/COPPER
ARGENTO COMETA/SILVER COMET
OTTONE VENEZIANO/BRASS
TITANIO/TITANIUM
BRONZO RIACI/RIACI BRONZE
VERDE COSTA/GREEN COAST
TERRA SENESE/SENESE EARTH

CODICE
CODE

1010500003
1010501003
1010502003
1010503003
1010504003
1010505003
1010509003
1010510003
1030712003
1030713003
1030714003
1090715003
1090716003
1010517003

“linee pulite ed essenziali”

Non sempre piccolo è sinonimo di inefficienza; nel nostro profilo U01 è racchiusa la massima espressione tecnologica dell'estrusione dell'alluminio finalizzata alla dissipazione termica. Luce morbida e diffusa grazie alla cover dedicata in policarbonato. Linee pulite ed essenziali.

Small is not always synonym for inefficiency, in our U01 profile is contained the highest expression of technology aimed at the aluminum extrusion heat dissipation. Soft and diffused light thanks to dedicated polycarbonate cover. Clean and essential lines.



ut01

led integrato

integrated led

COVER POSA IN OPERA INCLUSA
(COVER MONOUSO PER PROTEGGERE IL PROFILO DURANTE LE FASI DI INSTALLAZIONE)

COVER INSTALLED IS INCLUDED
(DISPOSABLE COVER TO PROTECT THE PROFILE DURING THE INSTALLATION PHASES)

TESTATE NON INCLUSE
DEAD ENDS NOT INCLUDED

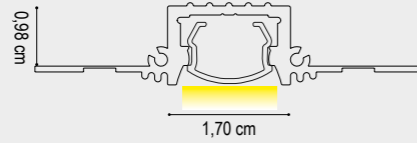

DATI TECNICI
TECHNICAL DATA



	1 cm
LED Flux Tot:	2200 lm/m
Flux Tot:	1680 lm/m
Output:	110 lm/W
CCT:	3000 K
CRI:	>90
Power Tot:	20.0 W/m
Weight:	0.90 Kg/m

Profilo/Profile: Alluminio/aluminum
Cover: Opale/opal

FINITURA STRUTTURA FINISHES	DIFFUSORE DIFFUSER	2700K 1 cm	3000K 1 cm	4000K 1 cm
		CODICE CODE	CODICE CODE	CODICE CODE
BIANCO INTONACO/WHITE	OPALE/OPAL	10T4603001	10T4703001	10T4803001
ALLUMINIO NATURALE/ALUMINUM		10T4606001	10T4706001	10T4806001

COVER POSA IN OPERA INCLUSA
(COVER MONOUSO PER PROTEGGERE IL PROFILO DURANTE LE FASI DI INSTALLAZIONE)

COVER INSTALLED IS INCLUDED
(DISPOSABLE COVER TO PROTECT THE PROFILE DURING THE INSTALLATION PHASES)

TESTATE NON INCLUSE
DEAD ENDS NOT INCLUDED

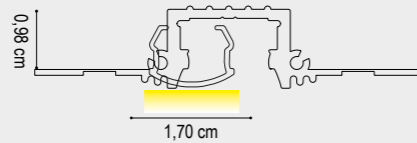

DATI TECNICI
TECHNICAL DATA



	1 cm
LED Flux Tot:	1584 lm/m
Flux Tot:	1267 lm/m
Output:	110 lm/W
CCT:	3000 K
CRI:	>95
Power Tot:	14.4W/m
Weight:	0.40 Kg/m

Profilo/Profile: Alluminio/aluminum
Cover: Opale/opal

FINITURA STRUTTURA FINISHES	DIFFUSORE DIFFUSER	2700K 1 cm	3000K 1 cm	4000K 1 cm
		CODICE CODE	CODICE CODE	CODICE CODE
BIANCO INTONACO/WHITE	OPALE/OPAL	10TG103001	10TG203001	10TG303001
ALLUMINIO NATURALE/ALUMINUM		10TG106001	10TG206001	10TG306001

TESTATE DI CHIUSURA / DEAD ENDS

FINITURA STRUTTURA FINISHES	CODICE CODE
BIANCO INTONACO/WHITE	U0104T03
ALLUMINIO NATURALE/ALUMINUM	U0104T06

Nel codice sono comprese le viti per il fissaggio delle testate al profilo. Il codice contiene n° 1 testate di chiusura. / The code includes the screws for fixing the heads to the profile. The code contains 1 closing warheads



ut01

profilo e cover

profile and diffuser

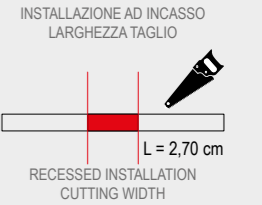
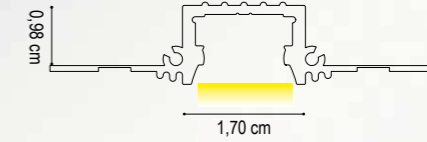
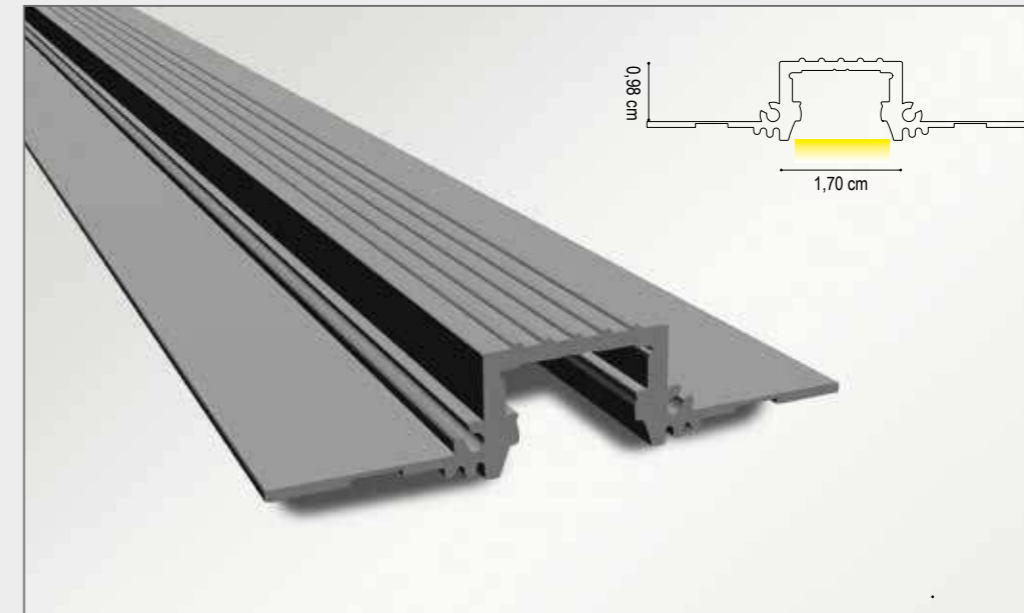

Profilo in alluminio
Profile in aluminum

FINITURA STRUTTURA FINISHES	1 cm	200 cm	300 cm
	CODICE CODE	CODICE CODE	CODICE CODE
BIANCO INTONACO/WHITE	101T303001	101T303200	101T303300
ALLUMINIO NATURALE/ALUMINUM	101T306001	101T306200	101T306300

LAVORAZIONI / PROCESSING

DATI TECNICI TECHNICAL DATA	CODICE CODE
TAGLIO 90° ORIZZONTALE (PER ANGOLI FORMATI DA DUE PROFILI) HORIZONTAL 90 ° CUT (FOR CORNERS MADE OF TWO PROFILES)	190X
TAGLIO 90° VERTICALE (PER ANGOLI FORMATI DA DUE PROFILI) VERTICAL 90 ° CUT (FOR CORNERS MADE OF TWO PROFILES)	190Y
TAGLIO ANGOLARE CUSTOM (PER ANGOLI FORMATI DA DUE PROFILI) CUSTOM CORNER CUT (FOR CORNERS MADE OF TWO PROFILES)	190N
ASOLA / SLOT	100A
ASOLA CUSTOM / SLOT CUSTOM	100N
FORO / HOLE	100F
CABLAGGIO - COLLAUDO - CE AL CENTIMETRO INSTALLATION AND TESTING LED MODULE AT CENTIMETER	1011
CONNETTORE MASCHIO/FEMMINA MALE/FEMALE CONNECTOR	98CFM
CONNETTORE MASCHIO/FEMMINA MONTATO NEL PRODOTTO MALE/FEMALE CONNECTOR FITTED IN THE PRODUCT	98MFM
CAVO DI ALIMENTAZIONE 2X0,50 BIANCO 1CM POWER CABLE 2X0,50 WHITE 1CM	98CB001
CAVO DI ALIMENTAZIONE 2X0,50 NERO 1CM POWER CABLE 2X0,50 BLACK 1CM	98CN001

ut02

led integrato

integrated led

COVER POSA IN OPERA INCLUSA
(COVER MONOUSO PER PROTEGGERE IL PROFILO DURANTE LE FASI DI INSTALLAZIONE)

COVER INSTALLED IS INCLUDED
(DISPOSABLE COVER TO PROTECT THE PROFILE DURING THE INSTALLATION PHASES)

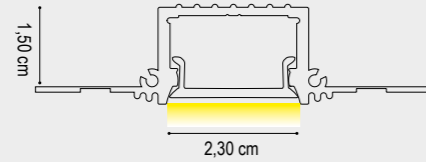

DATI TECNICI
TECHNICAL DATA



	1 cm
LED Flux Tot:	2200 lm/m
Flux Tot:	1680 lm/m
Output:	110 lm/W
CCT:	3000 K
CRI:	>90
Power Tot:	20.0 W/m
Weight:	0.90 Kg/m

Profilo/Profile: Alluminio/aluminum
Cover: Opale/opal

TESTATE NON INCLUSE
DEAD ENDS NOT INCLUDED

FINITURA STRUTTURA FINISHES	DIFFUSORE DIFFUSER	2700K 1 cm	3000K 1 cm	4000K 1 cm
		CODICE CODE	CODICE CODE	CODICE CODE
BIANCO INTONACO/WHITE	OPALE/OPAL	13T4603001	13T4703001	13T4803001
ALLUMINIO NATURALE/ALUMINUM		13T4606001	13T4706001	13T4806001

COVER POSA IN OPERA INCLUSA
(COVER MONOUSO PER PROTEGGERE IL PROFILO DURANTE LE FASI DI INSTALLAZIONE)

COVER INSTALLED IS INCLUDED
(DISPOSABLE COVER TO PROTECT THE PROFILE DURING THE INSTALLATION PHASES)

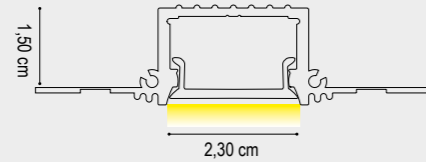

DATI TECNICI
TECHNICAL DATA



	1 cm
LED Flux Tot:	1584 lm/m
Flux Tot:	1267 lm/m
Output:	110 lm/W
CCT:	3000 K
CRI:	>95
Power Tot:	14.4W/m
Weight:	0.40 Kg/m

Profilo/Profile: Alluminio/aluminum
Cover: Opale/opal

TESTATE NON INCLUSE
DEAD ENDS NOT INCLUDED

FINITURA STRUTTURA FINISHES	DIFFUSORE DIFFUSER	2700K 1 cm	3000K 1 cm	4000K 1 cm
		CODICE CODE	CODICE CODE	CODICE CODE
BIANCO INTONACO/WHITE	OPALE/OPAL	13TG103001	13TG203001	13TG303001
ALLUMINIO NATURALE/ALUMINUM		13TG106001	13TG206001	13TG306001

TESTATE DI CHIUSURA / DEAD ENDS

FINITURA STRUTTURA FINISHES	CODICE CODE
	BIANCO INTONACO/WHITE
ALLUMINIO NATURALE/ALUMINUM	U0104T06

Nel codice sono comprese le viti per il fissaggio delle testate al profilo. Il codice contiene n° 1 testate di chiusura. / The code includes the screws for fixing the heads to the profile. The code contains 1 closing warheads



ut02

profilo e cover

profile and diffuser

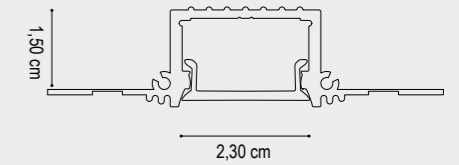

INSTALLAZIONE AD INCASSO
LARGHEZZA TAGLIO

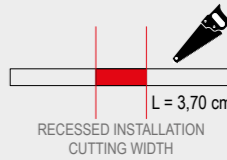

Profilo in alluminio
Profile in aluminum

FINITURA STRUTTURA FINISHES	1 cm	200 cm	300 cm
	CODICE CODE	CODICE CODE	CODICE CODE
BIANCO INTONACO/WHITE	103T303001	103T303200	103T303300
ALLUMINIO NATURALE/ALUMINUM	103T306001	103T306200	103T306300

LAVORAZIONI / PROCESSING

DATI TECNICI TECHNICAL DATA	CODICE CODE
TAGLIO 90° ORIZZONTALE (PER ANGOLI FORMATI DA DUE PROFILI) HORIZONTAL 90 ° CUT (FOR CORNERS MADE OF TWO PROFILES)	190X
TAGLIO 90° VERTICALE (PER ANGOLI FORMATI DA DUE PROFILI) VERTICAL 90 ° CUT (FOR CORNERS MADE OF TWO PROFILES)	190Y
TAGLIO ANGOLARE CUSTOM (PER ANGOLI FORMATI DA DUE PROFILI) CUSTOM CORNER CUT (FOR CORNERS MADE OF TWO PROFILES)	190N
ASOLA / SLOT	100A
ASOLA CUSTOM / SLOT CUSTOM	100N
FORO / HOLE	100F
CABLAGGIO - COLLAUDO - CE AL CENTIMETRO INSTALLATION AND TESTING LED MODULE AT CENTIMETER	1031
CONNETTORE MASCHIO/FEMMINA MALE/FEMALE CONNECTOR	98CFM
CONNETTORE MASCHIO/FEMMINA MONTATO NEL PRODOTTO MALE/FEMALE CONNECTOR FITTED IN THE PRODUCT	98MFM
CAVO DI ALIMENTAZIONE 2X0,50 BIANCO 1CM POWER CABLE 2X0,50 WHITE 1CM	98CB001
CAVO DI ALIMENTAZIONE 2X0,50 NERO 1CM POWER CABLE 2X0,50 BLACK 1CM	98CN001

“linee pulite ed essenziali”

Non sempre piccolo è sinonimo di inefficienza; nel nostro profilo U01 è racchiusa la massima espressione tecnologica dell'estrusione dell'alluminio finalizzata alla dissipazione termica. Luce morbida e diffusa grazie alla cover dedicata in policarbonato. Linee pulite ed essenziali.

Small is not always synonym for inefficiency, in our U01 profile is contained the highest expression of technology aimed at the aluminum extrusion heat dissipation. Soft and diffused light thanks to dedicated polycarbonate cover. Clean and essential lines.



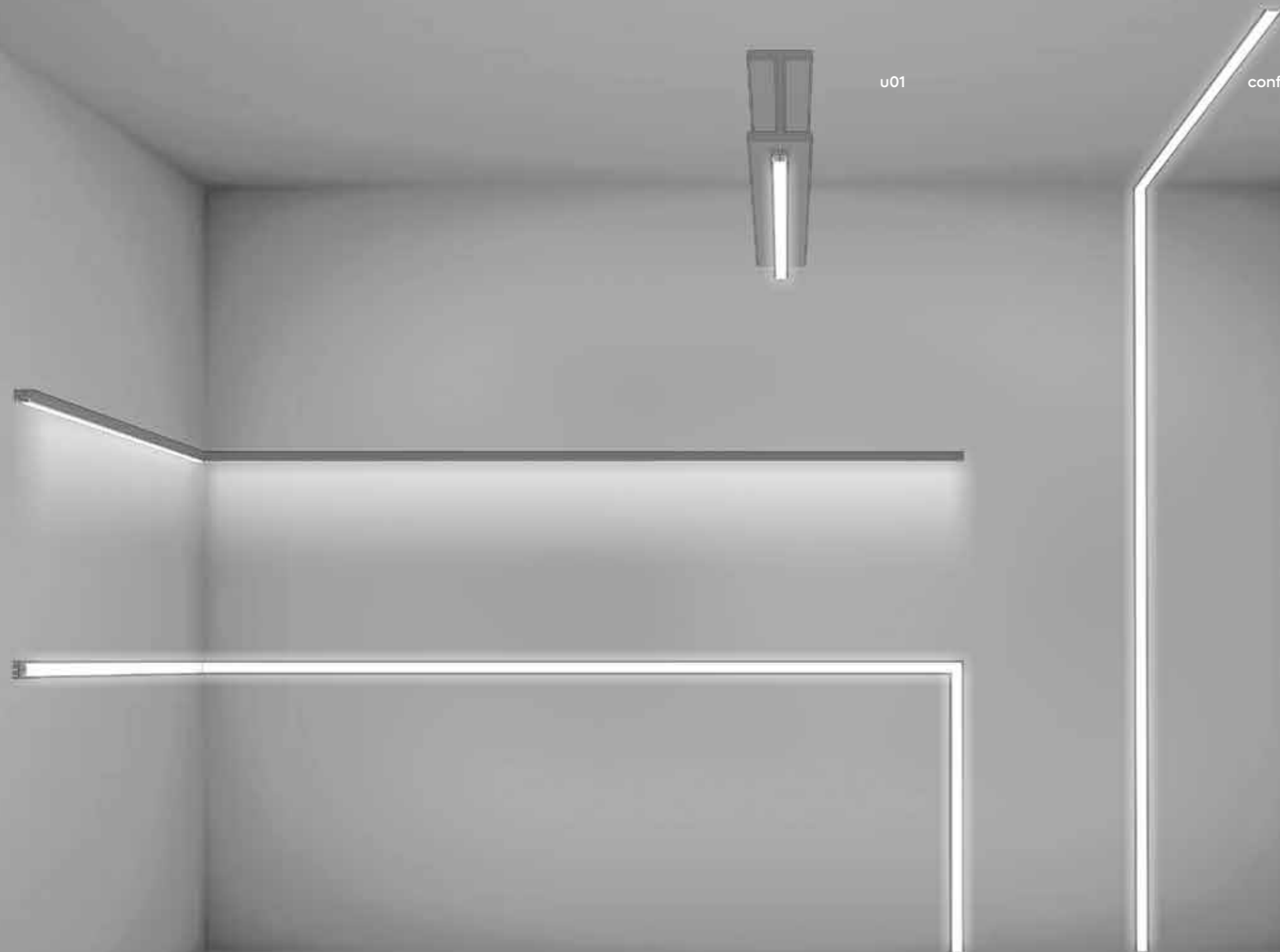

INSTALLAZIONE CON CLIP IN POLICARBONATO SU SUPERFICIE ORIZZONTALE
INSTALLATION WITH POLYCARBONATE CLIP ON HORIZONTAL SURFACE

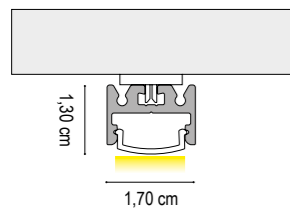

INSTALLAZIONE CON CLIP IN POLICARBONATO SU SUPERFICIE VERTICALE
INSTALLATION WITH POLYCARBONATE CLIP ON A VERTICAL SURFACE

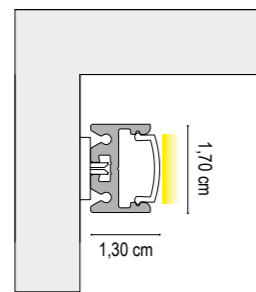

INSTALLAZIONE CON CALAMITA SU SUPERFICIE METALLICA ORIZZONTALE E VERTICALE
INSTALLATION WITH MAGNET ON HORIZONTAL AND VERTICAL METAL SURFACE

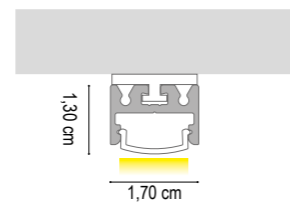

SI RACCOMANDA L'UTILIZZO DI N° 1 STAFFA MAGNETICA OGNI 25,00 cm DI PROFILO. TALE QUANTITÀ PUÒ VARIARE A SECONDA DELLA SUPERFICIE METALLICA DI INSTALLAZIONE.

WE RECOMMEND THE USE OF N° 1 MAGNETIC BRACKET EVERY 25.00 cm OF PROFILE. THIS QUANTITY MAY VARY DEPENDING ON THE METAL INSTALLATION SURFACE.

INSTALLAZIONE A PARETE
WALL INSTALLATION

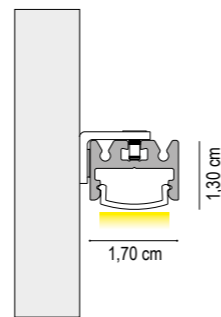

INSTALLAZIONE CON STAFFA PER INCASSO
INSTALLATION WITH BUILT-IN BRACKET

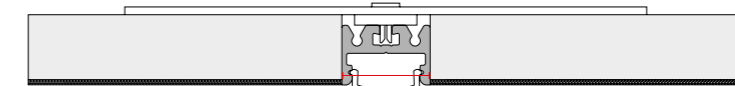

1,70 cm

INSTALLAZIONE AD INCASSO
LARGHEZZA TAGLIO L=2,60cm
RECESSED INSTALLATION
CUTTING WIDTH L=2,0cm

LE CONFIGURAZIONI SOPRA RIPORTATE SONO COMPATIBILI PER LA VERSIONE CON DIFFUSORE SEMITONDO E PER LA VERSIONE CON DIFFUSORE TONDO
THE CONFIGURATIONS SHOWN ABOVE ARE COMPATIBLE FOR THE VERSION WITH HALF-ROUND SPEAKER AND FOR THE VERSION WITH ROUND SPEAKER

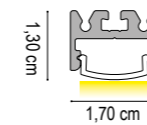

U01 CON DIFFUSORE SEMITONDO
U01 WITH HALF ROUND DIFFUSER

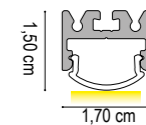

U01 CON DIFFUSORE TONDO
U01 WITH ROUND DIFFUSER

ATTENZIONE! GLI ACCESSORI PER L'INSTALLAZIONE A INCASSO SONO STATI DIMENSIONATI PER UN PANNELLO STANDARD IN CARTONGESSO DI SPESSORE 12,5 mm
WARNING! THE BUILT-IN INSTALLATION ACCESSORIES HAVE BEEN DIMENSIONED FOR A STANDARD PLASTERBOARD PANEL OF 12.5 mm THICKNESS

u01

led integrato

led integrated

DATI TECNICI
TECHNICAL DATA

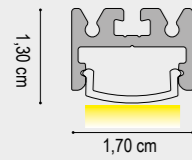

	1 cm	200 cm	300 cm
Nominal LED Flux:	1200 lm/m	2400 lm	3600 lm
Flux Tot:	960 lm/m	1920 lm	2880 lm
Output:	85 lm/W	85 lm/W	85 lm/W
CCT:	3000 K	3000 K	3000 K
CRI:	>90	>90	>90
Power Tot:	14.4 W/m	28.8 W	43.2 W
Weight:	0.40 Kg/m	0.80 Kg	1.20 Kg

Profilo/Profile: Alluminio/aluminum

Cover: Opale/opal

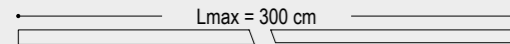

DRIVER NON INCLUSO / NOT INCLUDED

CAVO ALIMENTAZIONE: 50 cm
ALIMENTATION CABLE: 50 cm

u01

led integrato

led integrated

DATI TECNICI
TECHNICAL DATA

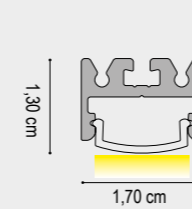

	1 cm	200 cm	300 cm
Nominal LED Flux:	1600 lm/m	3200 lm	4800 lm
Flux Tot:	1280 lm/m	2560 lm	3840 lm
Output:	85 lm/W	85 lm/W	85 lm/W
CCT:	3000 K	3000 K	3000 K
CRI:	>90	>90	>90
Power Tot:	19.2 W/m	38.4 W	57.6 W
Weight:	0.40 Kg/m	0.80 Kg	1.20 Kg

Profilo/Profile: Alluminio/aluminum

Cover: Opale/opal

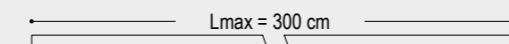

DRIVER NON INCLUSO / NOT INCLUDED

CAVO ALIMENTAZIONE: 50 cm
ALIMENTATION CABLE: 50 cm

FINITURA STRUTTURA FINISHES	DIFFUSORE DIFFUSER	1 cm CODICE CODE	200 cm CODICE CODE	300 cm CODICE CODE
GRIGIO VESUVIO/ANTHRACITE	OPALE/OPAL	101050001	1010500200	1010500300
ARGILLA/ARGIL		1010501001	1010501200	1010501300
ARGENTO OPACO/MATT SILVER		1010502001	1010502200	1010502300
BIANCO INTONACO/WHITE		1010503001	1010503200	1010503300
NERO CARAVAGGIO/BLACK		1010504001	1010504200	1010504300
MOKA/MOCHA		1010505001	1010505200	1010505300
ORO CALIFORNIA/GOLD		1010509001	1010509200	1010509300
ARAMEN/COPPER		1010510001	1010510200	1010510300
ARGENTO COMETA/SILVER COMET		1010512001	1010512200	1010512300
OTTONE VENEZIANO/BRASS		1010513001	1010513200	1010513300
TITANIO/TITANIUM		1010514001	1010514200	1010514300
BRONZO RIACI/RIACI BRONZE		1010515001	1010515200	1010515300
VERDE COSTA/GREEN COAST		1010516001	1010516200	1010516300
TERRA SENESE/SENESE EARTH		1010517001	1010517200	1010517300
CROMO/CHROME		1010508001	1010508200	

ATTENZIONE/PLEASE NOTE: LUNGHEZZA MASSIMA VERSIONE CROMO = 2,00 m / MAXIMUM LENGTH CHROME VERSION = 2.00 m
TESTATE DI CHIUSURA NON INCLUSE / DEAD ENDS NOT INCLUDED

FINITURA STRUTTURA FINISHES	DIFFUSORE DIFFUSER	1 cm CODICE CODE	200 cm CODICE CODE	300 cm CODICE CODE
GRIGIO VESUVIO/ANTHRACITE	OPALE/OPAL	1010800001	1010800200	1010800300
ARGILLA/ARGIL		1010801001	1010801200	1010801300
ARGENTO OPACO/MATT SILVER		1010802001	1010802200	1010802300
BIANCO INTONACO/WHITE		1010803001	1010803200	1010803300
NERO CARAVAGGIO/BLACK		1010804001	1010804200	1010804300
MOKA/MOCHA		1010805001	1010805200	1010805300
ORO CALIFORNIA/GOLD		1010809001	1010809200	1010809300
ARAMEN/COPPER		1010810001	1010810200	1010810300
ARGENTO COMETA/SILVER COMET		1010812001	1010812200	1010812300
OTTONE VENEZIANO/BRASS		1010813001	1010813200	1010813300
TITANIO/TITANIUM		1010814001	1010814200	1010814300
BRONZO RIACI/RIACI BRONZE		1010815001	1010815200	1010815300
VERDE COSTA/GREEN COAST		1010816001	1010816200	1010816300
TERRA SENESE/SENESE EARTH		1010817001	1010817200	1010817300
CROMO/CHROME		1010808001	1010808200	

ATTENZIONE/PLEASE NOTE: LUNGHEZZA MASSIMA VERSIONE CROMO = 2,00 m / MAXIMUM LENGTH CHROME VERSION = 2.00 m
TESTATE DI CHIUSURA NON INCLUSE / DEAD ENDS NOT INCLUDED

u01

led integrato

led integrated

DATI TECNICI
TECHNICAL DATA

	1 cm
Nominal LED Flux:	1900 lm/m
Flux Tot:	1520 lm/m
Output:	158 lm/W
CCT:	3000 K
CRI:	>90
Power Tot:	12.0W/m
Weight:	0.40 Kg/m

Profilo/Profile: Alluminio/aluminum
Cover: Opale/opal

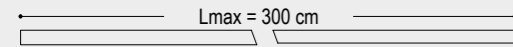
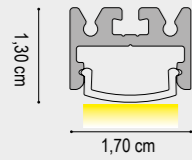

DRIVER NON INCLUSO / NOT INCLUDED

CAVO ALIMENTAZIONE: 50 cm
ALIMENTATION CABLE: 50 cm

u01

led integrato

led integrated

DATI TECNICI
TECHNICAL DATA

	1 cm
Nominal LED Flux:	1584 lm/m
Flux Tot:	1267 lm/m
Output:	110 lm/W
CCT:	3000 K
CRI:	>95
Power Tot:	14.4W/m
Weight:	0.40 Kg/m

Profilo/Profile: Alluminio/aluminum
Cover: Opale/opal

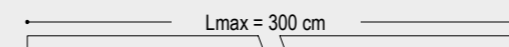
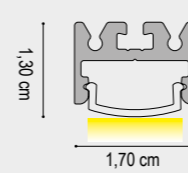

DRIVER NON INCLUSO / NOT INCLUDED

CAVO ALIMENTAZIONE: 50 cm
ALIMENTATION CABLE: 50 cm

FINITURA STRUTTURA FINISHES	DIFFUSORE DIFFUSER	1 cm		
		CODICE 2700K CODE 2700K	CODICE 3000K CODE 3000K	CODICE 4000K CODE 4000K
GRIGIO VESUVIO ANTHRACITE	OPALE/OPAL	1015400001	1015500001	1015600001
ARGILLA CLAY		1015401001	1015501001	1015601001
ARGENTO OPACO/MATT SILVER		1015402001	1015502001	1015602001
BIANCO INTONACO/WHITE		1015403001	1015503001	1015603001
NERO CARAVAGGIO/BLACK		1015404001	1015504001	1015604001
MOKA MOCHA		1015405001	1015505001	1015605001
CROMO/CHROME		1015408001	1015508001	1015608001
ORO CALIFORNIA/GOLD		1015409001	1015509001	1015609001
ARAMEN COPPER		1015410001	1015510001	1015610001
ARGENTO COMETA/SILVER COMET		1015412001	1015512001	1015612001
OTTONE VENEZIANO/BRASS		1015413001	1015513001	1015613001
TITANIO/TITANIUM		1015414001	1015514001	1015614001
BRONZO RIACI/RIACI BRONZE		1015415001	1015515001	1015615001
VERDE COSTA/GREEN COAST		1015416001	1015516001	1015616001
TERRA SENESE/SENESE EARTH		1015417001	1015517001	1015617001

N.B./P.N.: LUNGHEZZA MASSIMA VERSIONE CROMO = 2,00 m / MAXIMUM LENGTH CHROME VERSION = 2.00 m
TESTATE DI CHIUSURA NON INCLUSE / DEAD ENDS NOT INCLUDED

FINITURA STRUTTURA FINISHES	DIFFUSORE DIFFUSER	1 cm		
		CODICE 2700K CODE 2700K	CODICE 3000K CODE 3000K	CODICE 4000K CODE 4000K
GRIGIO VESUVIO ANTHRACITE	OPALE/OPAL	101K100001	101K200001	101K300001
ARGILLA CLAY		101K101001	101K201001	101K301001
ARGENTO OPACO/MATT SILVER		101K102001	101K202001	101K302001
BIANCO INTONACO/WHITE		101K103001	101K203001	101K303001
NERO CARAVAGGIO/BLACK		101K104001	101K204001	101K304001
MOKA MOCHA		101K105001	101K205001	101K305001
CROMO/CHROME		101K108001	101K208001	101K308001
ORO CALIFORNIA/GOLD		101K109001	101K209001	101K309001
ARAMEN COPPER		101K110001	101K210001	101K310001
ARGENTO COMETA/SILVER COMET		101K112001	101K212001	101K312001
OTTONE VENEZIANO/BRASS		101K113001	101K213001	101K313001
TITANIO/TITANIUM		101K114001	101K214001	101K314001
BRONZO RIACI/RIACI BRONZE		101K115001	101K215001	101K315001
VERDE COSTA/GREEN COAST		101K116001	101K216001	101K316001
TERRA SENESE/SENESE EARTH		101K117001	101K217001	101K317001

N.B./P.N.: LUNGHEZZA MASSIMA VERSIONE CROMO = 2,00 m / MAXIMUM LENGTH CHROME VERSION = 2.00 m
TESTATE DI CHIUSURA NON INCLUSE / DEAD ENDS NOT INCLUDED



u01

profilo e cover semitonda opale

profile and half round opal diffuser

Profilo in alluminio
Aluminium profile

Diffusore in policarbonato
Polycarbonate diffuser

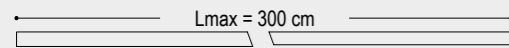
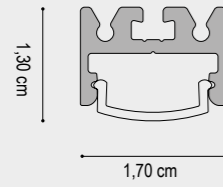

u01

profilo e cover semitonda opale

profile and half round opal diffuser

Profilo in alluminio
Aluminium profile

Diffusore in policarbonato
Polycarbonate diffuser

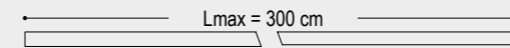
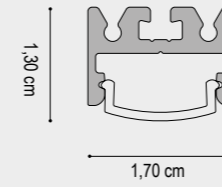

		1 cm	200 cm	300 cm
FINITURA STRUTTURA FINISHES	DIFFUSORE DIFFUSER	CODICE CODE	CODICE CODE	CODICE CODE
GRIGIO VESUVIO/ANTHRACITE	OPALE/OPAL	101CP00001	101CP00200	101CP00300
ARGILLA/ARGIL		101CP01001	101CP01200	101CP01300
ARGENTO OPACO/MATT SILVER		101CP02001	101CP02200	101CP02300
BIANCO INTONACO/WHITE		101CP03001	101CP03200	101CP03300
NERO CARAVAGGIO/BLACK		101CP04001	101CP04200	101CP04300
MOKA/MOCHA		101CP05001	101CP05200	101CP05300
ALLUMINIO NATURALE/ALUMINUM		101CP06001	101CP06200	101CP06300
ORO CALIFORNIA/GOLD		101CP09001	101CP09200	101CP09300
ARAMEN/COPPER		101CP10001	101CP10200	101CP10300
ARGENTO COMETA/SILVER COMET		101CP12001	101CP12200	101CP12300
OTTONE VENEZIANO/BRASS		101CP13001	101CP13200	101CP13300
TITANIO/TITANIUM		101CP14001	101CP14200	101CP14300
BRONZO RIACI/RIACI BRONZE		101CP15001	101CP15200	101CP15300
VERDE COSTA/GREEN COAST		101CP16001	101CP16200	101CP16300
TERRA SENESE/SENESE EARTH		101CP17001	101CP17200	101CP17300
CROMO/CHROME		101CP08001	101CP08200	

ATTENZIONE/PLEASE NOTE: LUNGHEZZA MASSIMA VERSIONE CROMO = 2,00 m / MAXIMUM LENGTH CHROME VERSION = 2.00 m
TESTATE DI CHIUSURA NON INCLUSE / DEAD ENDS NOT INCLUDED

		1 cm	200 cm	300 cm
FINITURA STRUTTURA FINISHES	DIFFUSORE DIFFUSER	CODICE CODE	CODICE CODE	CODICE CODE
GRIGIO VESUVIO/ANTHRACITE	TRASPARENTE TRANSPARENT	101CT00001	101CT00200	101CT00300
ARGILLA/ARGIL		101CT01001	101CT01200	101CT01300
ARGENTO OPACO/MATT SILVER		101CT02001	101CT02200	101CT02300
BIANCO INTONACO/WHITE		101CT03001	101CT03200	101CT03300
NERO CARAVAGGIO/BLACK		101CT04001	101CT04200	101CT04300
MOKA/MOCHA		101CT05001	101CT05200	101CT05300
ALLUMINIO NATURALE/ALUMINUM		101CT06001	101CT06200	101CT06300
ORO CALIFORNIA/GOLD		101CT09001	101CT09200	101CT09300
ARAMEN/COPPER		101CT10001	101CT10200	101CT10300
ARGENTO COMETA/SILVER COMET		101CT12001	101CT12200	101CT12300
OTTONE VENEZIANO/BRASS		101CT13001	101CT13200	101CT13300
TITANIO/TITANIUM		101CT14001	101CT14200	101CT14300
BRONZO RIACI/RIACI BRONZE		101CT15001	101CT15200	101CT15300
VERDE COSTA/GREEN COAST		101CT16001	101CT16200	101CT16300
TERRA SENESE/SENESE EARTH		101CT17001	101CT17200	101CT17300
CROMO/CHROME		101CT08001	101CT08200	

ATTENZIONE/PLEASE NOTE: LUNGHEZZA MASSIMA VERSIONE CROMO = 2,00 m / MAXIMUM LENGTH CHROME VERSION = 2.00 m
TESTATE DI CHIUSURA NON INCLUSE / DEAD ENDS NOT INCLUDED

LED compatibili / LED compatibility

HIGH QUALITY CRI>90 CRI>95	HIGH OUTPUT CRI>90 CRI>95	HIGH EFFICIENT CRI>90 CRI>95	HIGH INTENSITY CRI>90 CRI>95	LOW POWER CRI>90	ULTRA SLIM CRI>90 CRI>95 CRI>97	RGB	RGB WHITE	RGB TW	TUNABLE WHITE
9,6W 14,4W 19,2W	12,3W 14,4W 19,2W 20W 24W	12,3W 14,4W 19,2W 20W 24W	24W 24W (700 LED)	6W	9,6W 12W 14,4W	14W	14W	14,4W 23W	19,2W

LED compatibili / LED compatibility

HIGH QUALITY CRI>90 CRI>95	HIGH OUTPUT CRI>90 CRI>95	HIGH EFFICIENT CRI>90 CRI>95	HIGH INTENSITY CRI>90 CRI>95	LOW POWER CRI>90	ULTRA SLIM CRI>90 CRI>95 CRI>97	RGB	RGB WHITE	RGB TW	TUNABLE WHITE
9,6W 14,4W 19,2W	12,3W 14,4W 19,2W 20W 24W	12,3W 14,4W 19,2W 20W 24W	24W 24W (700 LED)	6W	9,6W 12W 14,4W	14W	14W	14,4W 23W	19,2W



u01

profilo e cover tonda opale

profile and half round opal diffuser

Profilo in alluminio
Aluminium profile

Diffusore in policarbonato
Polycarbonate diffuser

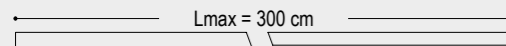
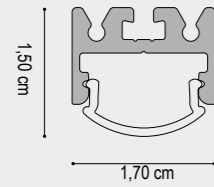

u01

profilo e cover tonda opale

profile and round trasparent diffuser

Profilo in alluminio
Aluminium profile

Diffusore in policarbonato
Polycarbonate diffuser

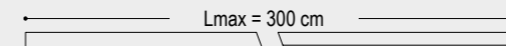
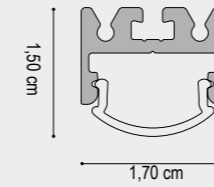

		1 cm	200 cm	300 cm
FINITURA STRUTTURA FINISHES	DIFFUSORE DIFFUSER	CODICE CODE	CODICE CODE	CODICE CODE
GRIGIO VESUVIO/ANTHRACITE	OPALE/OPAL	101CL00001	101CL00200	101CL00300
ARGILLA/ARGIL		101CL01001	101CL01200	101CL01300
ARGENTO OPACO/MATT SILVER		101CL02001	101CL02200	101CL02300
BIANCO INTONACO/WHITE		101CL03001	101CL03200	101CL03300
NERO CARAVAGGIO/BLACK		101CL04001	101CL04200	101CL04300
MOKA/MOCHA		101CL05001	101CL05200	101CL05300
ALLUMINIO NATURALE/ALUMINUM		101CL06001	101CL06200	101CL06300
ORO CALIFORNIA/GOLD		101CL09001	101CL09200	101CL09300
ARAMEN/COPPER		101CL10001	101CL10200	101CL10300
ARGENTO COMETA/SILVER COMET		101CL12001	101CL12200	101CL12300
OTTONE VENEZIANO/BRASS		101CL13001	101CL13200	101CL13300
TITANIO/TITANIUM		101CL14001	101CL14200	101CL14300
BRONZO RIACI/RIACI BRONZE		101CL15001	101CL15200	101CL15300
VERDE COSTA/GREEN COAST		101CL16001	101CL16200	101CL16300
TERRA SENESE/SENESE EARTH		101CL17001	101CL17200	101CL17300
CROMO/CHROME		101CL08001	101CL08200	

ATTENZIONE/PLEASE NOTE: LUNGHEZZA MASSIMA VERSIONE CROMO = 2,00 m / MAXIMUM LENGTH CHROME VERSION = 2.00 m
TESTATE DI CHIUSURA NON INCLUSE / DEAD ENDS NOT INCLUDED

		1 cm	200 cm	300 cm
FINITURA STRUTTURA FINISHES	DIFFUSORE DIFFUSER	CODICE CODE	CODICE CODE	CODICE CODE
GRIGIO VESUVIO/ANTHRACITE	TRASPARENTE TRASPARENT	101CR00001	101CR00200	101CR00300
ARGILLA/ARGIL		101CR01001	101CR01200	101CR01300
ARGENTO OPACO/MATT SILVER		101CR02001	101CR02200	101CR02300
BIANCO INTONACO/WHITE		101CR03001	101CR03200	101CR03300
NERO CARAVAGGIO/BLACK		101CR04001	101CR04200	101CR04300
MOKA/MOCHA		101CR05001	101CR05200	101CR05300
ALLUMINIO NATURALE/ALUMINUM		101CR06001	101CR06200	101CR06300
ORO CALIFORNIA/GOLD		101CR09001	101CR09200	101CR09300
ARAMEN/COPPER		101CR10001	101CR10200	101CR10300
ARGENTO COMETA/SILVER COMET		101CR12001	101CR12200	101CR12300
OTTONE VENEZIANO/BRASS		101CR13001	101CR13200	101CR13300
TITANIO/TITANIUM		101CR14001	101CR14200	101CR14300
BRONZO RIACI/RIACI BRONZE		101CR15001	101CR15200	101CR15300
VERDE COSTA/GREEN COAST		101CR16001	101CR16200	101CR16300
TERRA SENESE/SENESE EARTH		101CR17001	101CR17200	101CR17300
CROMO/CHROME		101CR08001	101CR08200	

ATTENZIONE/PLEASE NOTE: LUNGHEZZA MASSIMA VERSIONE CROMO = 2,00 m / MAXIMUM LENGTH CHROME VERSION = 2.00 m
TESTATE DI CHIUSURA NON INCLUSE / DEAD ENDS NOT INCLUDED

LED compatibili / LED compatibility

HIGH QUALITY CRI>90 CRI>95	HIGH OUTPUT CRI>90 CRI>95	HIGH EFFICIENT CRI>90 CRI>95	HIGH INTENSITY CRI>90 CRI>95	LOW POWER CRI>90	ULTRA SLIM CRI>90 CRI>95 CRI>97	RGB	RGB WHITE	RGB TW	TUNABLE WHITE
9,6W 14,4W 19,2W	12,3W 14,4W 19,2W 20W 24W	12,3W 14,4W 19,2W 20W 24W	24W 24W (700 LED)	6W	9,6W 12W 14,4W	14W	14W	14,4W 23W	19,2W

LED compatibili / LED compatibility

HIGH QUALITY CRI>90 CRI>95	HIGH OUTPUT CRI>90 CRI>95	HIGH EFFICIENT CRI>90 CRI>95	HIGH INTENSITY CRI>90 CRI>95	LOW POWER CRI>90	ULTRA SLIM CRI>90 CRI>95 CRI>97	RGB	RGB WHITE	RGB TW	TUNABLE WHITE
9,6W 14,4W 19,2W	12,3W 14,4W 19,2W 20W 24W	12,3W 14,4W 19,2W 20W 24W	24W 24W (700 LED)	6W	9,6W 12W 14,4W	14W	14W	14,4W 23W	19,2W





TESTATE DI CHIUSURA / DEAD ENDS

FINITURA STRUTTURA FINISHES	CODICE CODE	FINITURA STRUTTURA FINISHES	CODICE CODE
GRIGIO VESUVIO/ANTHRACITE	1010400000	ORO CALIFORNIA/GOLD	1010409000
ARGILLA/ARGIL	1010401000	ARAMEN/COPPER	1010410000
ARGENTO OPACO/MATT SILVER	1010402000	ARGENTO COMETA/SILVER COMET	1010412000
BIANCO INTONACO/WHITE	1010403000	OTTONE VENEZIANO/BRASS	1010413000
NERO CARAVAGGIO/BLACK	1010404000	TITANIO/TITANIUM	1010414000
MOKA/MOCHA	1010405000	BRONZO RIACI/RIACI BRONZE	1010415000
ALLUMINIO NATURALE/ALUMINUM	1010406000	VERDE COSTA/GREEN COAST	1010416000
CROMO/CHROME	1010408000	TERRA SENESE/SENESE EARTH	1010417000

Nel codice sono comprese le viti per il fissaggio delle testate al profilo. Il codice contiene n° 1 testate di chiusura. / The code includes the screws for fixing the heads to the profile. The code contains 1 closing warheads



FINITURA STRUTTURA FINISHES	CODICE CODE	FINITURA STRUTTURA FINISHES	CODICE CODE
GRIGIO VESUVIO/ANTHRACITE	1010500000	ORO CALIFORNIA/GOLD	1010509000
ARGILLA/ARGIL	1010501000	ARAMEN/COPPER	1010510000
ARGENTO OPACO/MATT SILVER	1010502000	ARGENTO COMETA/SILVER COMET	1010512000
BIANCO INTONACO/WHITE	1010503000	OTTONE VENEZIANO/BRASS	1010513000
NERO CARAVAGGIO/BLACK	1010504000	TITANIO/TITANIUM	1010514000
MOKA/MOCHA	1010505000	BRONZO RIACI/RIACI BRONZE	1010515000
ALLUMINIO NATURALE/ALUMINUM	1010506000	VERDE COSTA/GREEN COAST	1010516000
CROMO/CHROME	1010508000	TERRA SENESE/SENESE EARTH	1010517000

Nel codice sono comprese le viti per il fissaggio delle testate al profilo. Il codice contiene n° 1 testate di chiusura. / The code includes the screws for fixing the heads to the profile. The code contains 1 closing warheads



FINITURA STRUTTURA FINISHES	CODICE CODE	FINITURA STRUTTURA FINISHES	CODICE CODE
GRIGIO VESUVIO/ANTHRACITE	1010600000	ORO CALIFORNIA/GOLD	1010609000
ARGILLA/ARGIL	1010601000	ARAMEN/COPPER	1010610000
ARGENTO OPACO/MATT SILVER	1010602000	ARGENTO COMETA/SILVER COMET	1010612000
BIANCO INTONACO/WHITE	1010603000	OTTONE VENEZIANO/BRASS	1010613000
NERO CARAVAGGIO/BLACK	1010604000	TITANIO/TITANIUM	1010614000
MOKA/MOCHA	1010605000	BRONZO RIACI/RIACI BRONZE	1010615000
ALLUMINIO NATURALE/ALUMINUM	1010606000	VERDE COSTA/GREEN COAST	1010616000
CROMO/CHROME	1010608000	TERRA SENESE/SENESE EARTH	1010617000

Nel codice sono comprese le viti per il fissaggio delle testate al profilo. Il codice contiene n° 1 testate di chiusura. / The code includes the screws for fixing the heads to the profile. The code contains 1 closing warheads

GIUNTI / JOINTS

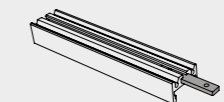
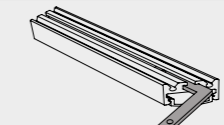
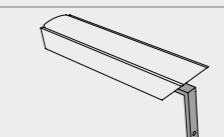
	FINITURA FINISHES	CODICE CODE
<p>GIUNTO LINEA CONTINUA / STRAIGHT JOINT</p> <p>Accessorio per giunzioni meccaniche lineari Accessory for linear mechanical joints</p> 	ALLUMINIO NATURALE/ALUMINUM	1010500006
<p>GIUNTO 90° ORIZZONTALE / HORIZONTAL JOINT 90°</p> <p>Accessorio per giunzioni meccaniche con angolo 90° Accessory for linear mechanical joints with 90° angle</p> 	ALLUMINIO NATURALE/ALUMINUM	1010500005
<p>GIUNTO 90° VERTICALE / VERTICAL JOINT 90°</p> <p>Accessorio per giunzioni meccaniche con angolo 90° Accessory for linear mechanical joints with 90° angle</p> 	ALLUMINIO NATURALE/ALUMINUM	1010500007

Nel codice sono compresi i grani per il fissaggio del giunto / The code includes the grains for fixing the joint.

STAFFA DI FISSAGGIO A PARETE / WALL MOUNTING CLIP

DATI TECNICI TECHNICAL DATA	FINITURA STRUTTURA FINISHES	CODICE CODE
MATERIALE: Alluminio naturale MATERIAL: Natural aluminum	GRIGIO VESUVIO/ANTHRACITE	101050003
	ARGILLA/ARGIL	1010501003
Nel codice è compresa la vite per il fissaggio della staffa al profilo The code includes the screw for fixing the bracket to the profile	ARGENTO OPACO/MATT SILVER	1010502003
	BIANCO INTONACO/WHITE	1010503003
	NERO CARAVAGGIO/BLACK	1010504003
	MOKA/MOCHA	1010505003
	ORO CALIFORNIA/GOLD	1010509003
	ARAMEN/COPPER	1010510003
	ARGENTO COMETA/SILVER COMET	1010712003
	OTTONE VENEZIANO/BRASS	1010713003
	TITANIO/TITANIUM	1010714003
	BRONZO RIACI/RIACI BRONZE	1010715003
	VERDE COSTA/GREEN COAST	1010716003
	TERRA SENESE/SENESE EARTH	1010517003

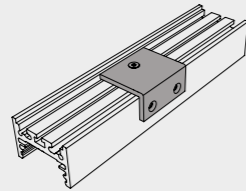

STAFFA DI FISSAGGIO / MOUNTING CLIP

FINITURA FINISHES	CODICE CODE
SUPERFICI PIANE 2mm EVEN SURFACE 2mm	1020500003
SUPERFICI IRREGOLARI 3,5mm UNEVEN SURFACE 3,5mm	1020500004

Accessorio per fissaggio a plafone/superficie. Quantità raccomandata: 1 pz ogni 50 cm di profilo
 Ceiling/surface mounting accessory. Recommended quantity: 1 pc every 50 cm of profile

STAFFA INCASSO PER CARTONGESSO / SEMI-BASED BRACKET FOR PLASTERBOARD

DATI TECNICI TECHNICAL DATA	FINITURA STRUTTURA FINISHES	CODICE CODE
ARTICOLI INCLUSI NEL CODICE ARTICLES INCLUDED IN THE CODE	ALLUMINIO NATURALE/ALUMINUM	1090500001
Clip di fissaggio in policarbonato 3mm Fixing clip in 3mm polycarbonate Viti per il fissaggio del profilo alla staffa Screws for fixing the profile to the bracket		

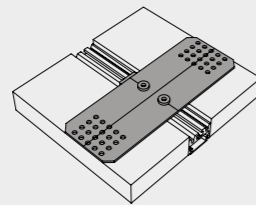

VERSIONE KIT / KIT VERSION

DATI TECNICI TECHNICAL DATA	FINITURA FINISHES	DIFFUSORE DIFFUSER	200 cm	300 cm
			CODICE CODE	CODICE CODE
ARTICOLI INCLUSI NEL CODICE ARTICLES INCLUDED IN THE CODE	ARGENTO OPACO/MATT SILVER	OPALE/OPAL	101P22	101P23
	BIANCO INTONACO/WHITE		101P32	101P33
	NERO CARAVAGGIO/BLACK		101P42	101P43
	ARGENTO OPACO/MATT SILVER	TRASPARENTE TRANSPARENT	101T22	101T23
	BIANCO INTONACO/WHITE		101T32	101T33
	NERO CARAVAGGIO/BLACK		101T42	101T43



INTERRUTTORE DIMMERABILE / DIMMABLE SWITCH

DATI TECNICI TECHNICAL DATA	FINITURA STRUTTURA FINISHES	CODICE CODE
Accessorio che consente l'accensione e lo spegnimento dei LED e, a seconda della pressione, la regolazione dell'intensità luminosa. Accessory that allows the switching on and off of the LEDs and, depending on the pressure, the regulation of the light intensity.	ALLUMINIO NATURALE/ALUMINUM	98243
Tensione di alimentazione: 12-24V DC Supply voltage: 12-24V DC Corrente d'uscita: 4A max Output current: 4A max ON / OFF: contact < 0.7 s DIMMER: contact > 0.7 s		



INTERRUTTORE DIMMERABILE+INSTALLAZIONE / DIMMABLE SWITCH+INSTALLATION

DATI TECNICI TECHNICAL DATA	FINITURA STRUTTURA FINISHES	CODICE CODE
Accessorio che consente l'accensione e lo spegnimento dei LED e, a seconda della pressione, la regolazione dell'intensità luminosa. Accessory that allows the switching on and off of the LEDs and, depending on the pressure, the regulation of the light intensity.	ALLUMINIO NATURALE/ALUMINUM	98244
Tensione di alimentazione: 12-24V DC Supply voltage: 12-24V DC Corrente d'uscita: 4A max Output current: 4A max ON / OFF: contact < 0.7 s DIMMER: contact > 0.7 s		

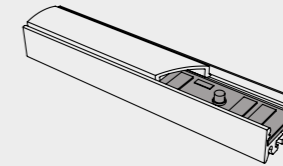

LAVORAZIONI / PROCESSING

DATI TECNICI TECHNICAL DATA	CODICE CODE
TAGLIO 90° ORIZZONTALE (PER ANGOLI FORMATI DA DUE PROFILI) HORIZONTAL 90 ° CUT (FOR CORNERS MADE OF TWO PROFILES)	190X
TAGLIO 90° VERTICALE (PER ANGOLI FORMATI DA DUE PROFILI) VERTICAL 90 ° CUT (FOR CORNERS MADE OF TWO PROFILES)	190Y
TAGLIO ANGOLARE CUSTOM (PER ANGOLI FORMATI DA DUE PROFILI) CUSTOM CORNER CUT (FOR CORNERS MADE OF TWO PROFILES)	190N
ASOLA / SLOT	100A
ASOLA CUSTOM / SLOT CUSTOM	100N
FORO / HOLE	100F
CABLAGGIO - COLLAUDO - CE AL CENTIMETRO INSTALLATION AND TESTING LED MODULE AT CENTIMETER	1011
CABLAGGIO - COLLAUDO CE - MONTAGGIO LED IP AL CENTIMETRO INSTALLATION - TESTING LED CE - ASSEMBLY LED IP AT CENTIMETER-	1016
CONNETTORE MASCHIO/FEMMINA MALE/FEMALE CONNECTOR	98CFM
CONNETTORE MASCHIO/FEMMINA MONTATO NEL PRODOTTO MALE/FEMALE CONNECTOR FITTED IN THE PRODUCT	98MFM
CAVO DI ALIMENTAZIONE 2X0,50 BIANCO 1CM POWER CABLE 2X0,50 WHITE 1CM	98CB001
CAVO DI ALIMENTAZIONE 2X0,50 NERO 1CM POWER CABLE 2X0,50 BLACK 1CM	98CN001

“semplicità, l'essenza delle forme e praticità”

U02 è frutto di una ricerca che tende ad abbinare la semplicità e l'essenza delle forme alla praticità delle nostre idee. Concetti illuminotecnici tradizionali si sposano alla perfezione con la nuova tecnologia LED, tutto questo per garantire il massimo rispetto dell'ambiente.

U02 è una soluzione discreta ed efficiente in tutti quei campi dove la luce è chiamata ad esaltare e valorizzare gli ambienti e i prodotti, arreda con discrezione sia gli spazi a te più cari e familiari che i luoghi più formali.

U02 is the result of our continuous research for combining essence and simplicity of forms, with the particularity of our ideas. Traditional lighting concepts are blended with new LED technology in the respect of the environment. U02 is a discrete and efficient solution in all the situations where light is necessary for enhancing products and interiors. U02 decorate with discretion whether your familiar spaces than formal places.



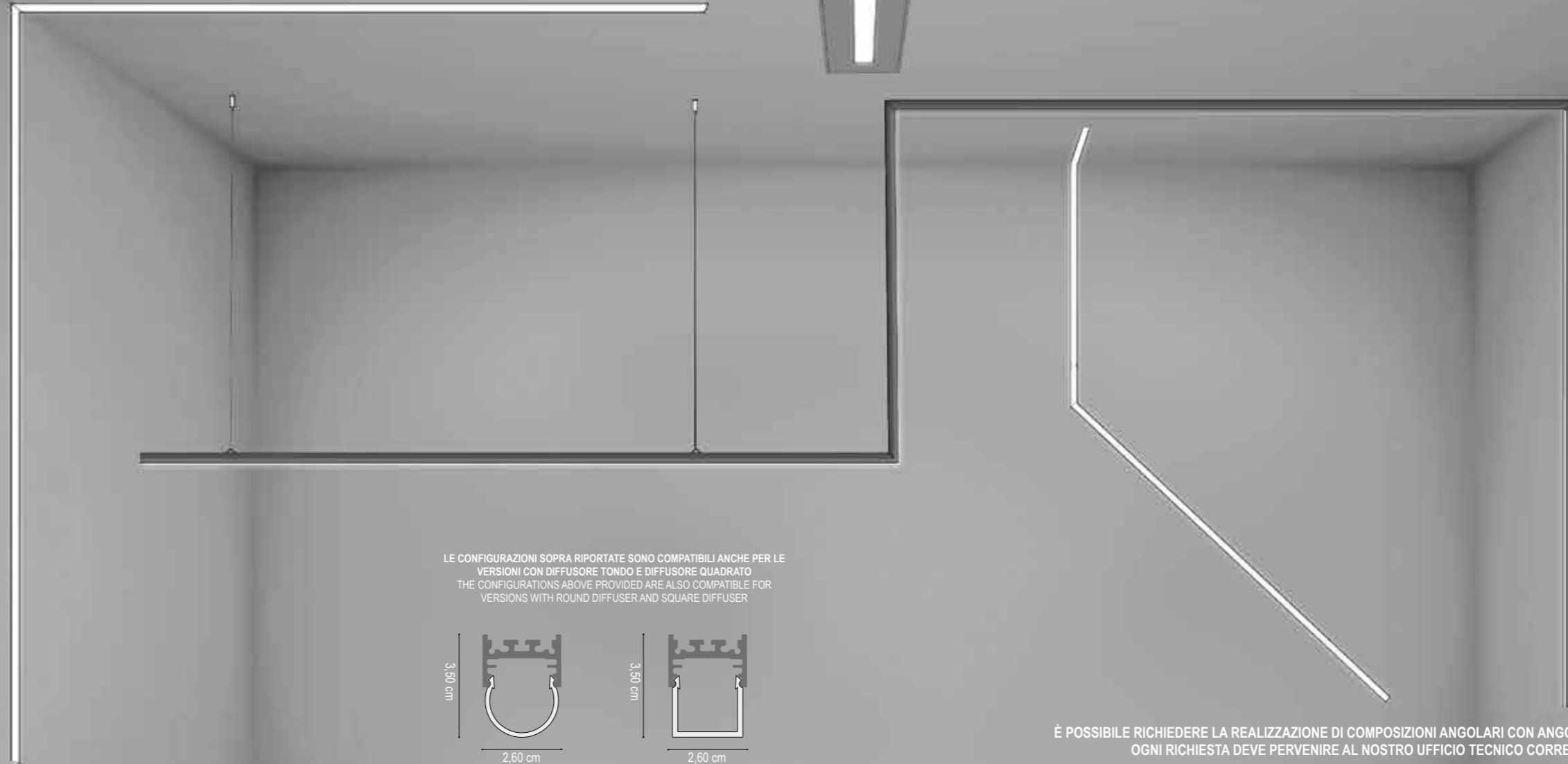

LE CONFIGURAZIONI SOPRA RIPORTATE SONO COMPATIBILI ANCHE PER LE VERSIONI CON DIFFUSORE TONDO E DIFFUSORE QUADRATO
 THE CONFIGURATIONS ABOVE PROVIDED ARE ALSO COMPATIBLE FOR VERSIONS WITH ROUND DIFFUSER AND SQUARE DIFFUSER

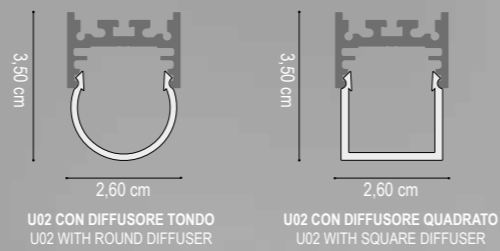

È POSSIBILE RICHIEDERE LA REALIZZAZIONE DI COMPOSIZIONI ANGOLARI CON ANGOLO DI AMPIEZZA DIVERSA DA 90°.
 OGNI RICHIESTA DEVE PERVENIRE AL NOSTRO UFFICIO TECNICO CORREDATA DA PROGETTO.
 IT IS POSSIBLE TO REQUEST THE CREATION OF ANGULAR COMPOSITIONS WITH AN ANGLE OF DIFFERENT 90°.
 EVERY REQUEST MUST COME TO OUR TECHNICAL OFFICE WITH PROJECT.

INSTALLAZIONE A SOSPENSIONE
SUSPENSION

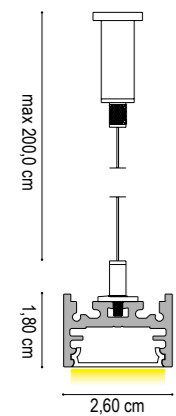

INSTALLAZIONE CON CLIP IN POLICARBONATO SU SUPERFICIE ORIZZONTALE
 INSTALLATION WITH POLYCARBONATE CLIP ON HORIZONTAL SURFACE

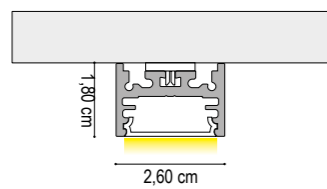

INSTALLAZIONE CON CALAMITA SU SUPERFICIE METALLICA ORIZZONTALE E VERTICALE
 INSTALLATION WITH MAGNET ON HORIZONTAL AND VERTICAL METAL SURFACE

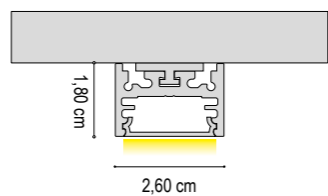

SI RACCOMANDA L'UTILIZZO DI N° 1 STAFFA MAGNETICA OGNI 25.00 cm DI PROFILO. TALE QUANTITÀ PUÒ VARIARE A SECONDA DELLA SUPERFICIE METALLICA DI INSTALLAZIONE.

WE RECOMMEND THE USE OF N° 1 MAGNETIC BRACKET EVERY 25.00 cm OF PROFILE. THIS QUANTITY MAY VARY DEPENDING ON THE METAL INSTALLATION SURFACE.

INSTALLAZIONE CON CLIP IN POLICARBONATO SU SUPERFICIE VERTICALE
 INSTALLATION WITH POLYCARBONATE CLIP ON A VERTICAL SURFACE

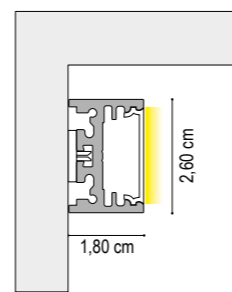

INSTALLAZIONE A SOSPENSIONE
SUSPENSION

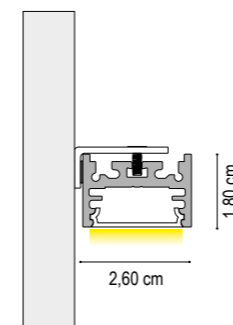

INSTALLAZIONE CON CLIP IN POLICARBONATO SU SUPERFICIE ORIZZONTALE
 INSTALLATION WITH POLYCARBONATE CLIP ON HORIZONTAL SURFACE

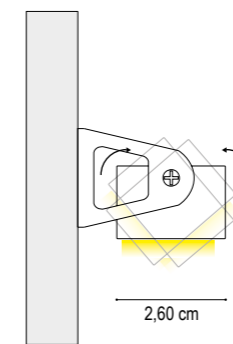

INSTALLAZIONE CON STAFFA PER SEMI INCASSO
 INSTALLATION WITH BUILT-IN BRACKET

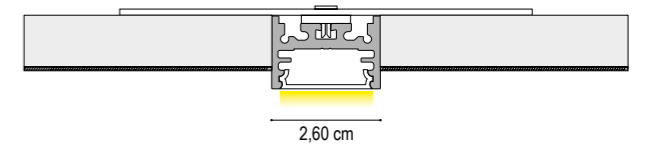

INSTALLAZIONE CON STAFFA PER INCASSO
 INSTALLATION WITH BUILT-IN BRACKET

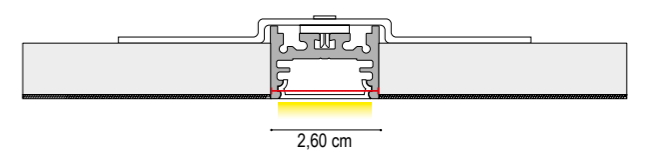

ATTENZIONE! GLI ACCESSORI PER L'INSTALLAZIONE A INCASSO SONO STATI DIMENSIONATI PER UN PANNELLO STANDARD IN CARTONGESSO DI SPESSORE 12,5 mm
 WARNING! THE BUILT-IN INSTALLATION ACCESSORIES HAVE BEEN DIMENSIONED FOR A STANDARD PLASTERBOARD PANEL OF 12.5 mm THICKNESS

INSTALLAZIONE AD INCASSO
 LARGHEZZA TAGLIO L=2,60cm
 RECESSED INSTALLATION
 CUTTING WIDTH L=2.0cm

u02

led integrato

integrated led

DATI TECNICI
TECHNICAL DATA

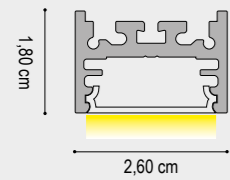

	1 cm	200 cm	300 cm
Nominal LED Flux:	1200 lm/m	2400 lm	3600 lm
Flux Tot:	960 lm/m	1920 lm	2880 lm
Output:	85 lm/W	85 lm/W	85 lm/W
CCT:	3000 K	3000 K	3000 K
CRI:	>90	>90	>90
Power Tot:	14.4 W/m	28.8 W	43.2 W
Weight:	0.50 Kg/m	1.00 Kg	1.50 Kg

Profilo/Profile: Alluminio/aluminum

Cover: Opale/opal

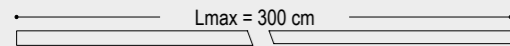

DRIVER NON INCLUSO / NOT INCLUDED

CAVO ALIMENTAZIONE: 50 cm
ALIMENTATION CABLE: 50 cm

u02

led integrato

integrated led

DATI TECNICI
TECHNICAL DATA

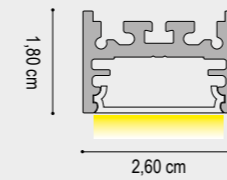

	1 cm	200 cm	300 cm
Nominal LED Flux:	1600 lm/m	3200 lm	4800 lm
Flux Tot:	1280 lm/m	2560 lm	3840 lm
Output:	85 lm/W	85 lm/W	85 lm/W
CCT:	3000 K	3000 K	3000 K
CRI:	>90	>90	>90
Power Tot:	19.2 W/m	38.4 W	57.6 W
Weight:	0.50 Kg/m	1.00 Kg	1.50 Kg

Profilo/Profile: Alluminio/aluminum

Cover: Opale/opal

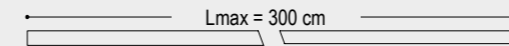

DRIVER NON INCLUSO / NOT INCLUDED

CAVO ALIMENTAZIONE: 50 cm
ALIMENTATION CABLE: 50 cm

		1 cm	200 cm	300 cm
FINITURA STRUTTURA FINISHES	DIFFUSORE DIFFUSER	CODICE CODE	CODICE CODE	CODICE CODE
GRIGIO VESUVIO/ANTHRACITE	OPALE/OPAL	1030500011	1030500200	1030500300
ARGILLA/ARGIL		1030501001	1030501200	1030501300
ARGENTO OPACO/MATT SILVER		1030502001	1030502200	1030502300
BIANCO INTONACO/WHITE		1030503001	1030503200	1030503300
NERO CARAVAGGIO/BLACK		1030504001	1030504200	1030504300
MOKA/MOCHA		1030505001	1030505200	1030505300
ORO CALIFORNIA/GOLD		1030509001	1030509200	1030509300
ARAMEN/COPPER		1030510001	1030510200	1030510300
GRIGIO AVIO/GREY AVIO		1030511001	1030511200	1030511300
ARGENTO COMETA/SILVER COMET		1030512001	1030512200	1030512300
OTTONE VENEZIANO/BRASS		1030513001	1030513200	1030513300
TITANIO/TITANIUM		1030514001	1030514200	1030514300
BRONZO RIACI/RIACI BRONZE		1030515001	1030515200	1030515300
VERDE COSTA/GREEN COAST		1030516001	1030516200	1030516300
TERRA SENESE/SENESE EARTH		1030517001	1030517200	1030517300
CROMO/CHROME		1030508001	1030508200	

ATTENZIONE/PLEASE NOTE: LUNGHEZZA MASSIMA VERSIONE CROMO = 2,00 m / MAXIMUM LENGTH CHROME VERSION = 2.00 m
TESTATE DI CHIUSURA NON INCLUSE / DEAD ENDS NOT INCLUDED

		1 cm	200 cm	300 cm
FINITURA STRUTTURA FINISHES	DIFFUSORE DIFFUSER	CODICE CODE	CODICE CODE	CODICE CODE
GRIGIO VESUVIO/ANTHRACITE	OPALE/OPAL	1030800001	1030800200	1030800300
ARGILLA/ARGIL		1030801001	1030801200	1030801300
ARGENTO OPACO/MATT SILVER		1030802001	1030802200	1030802300
BIANCO INTONACO/WHITE		1030803001	1030803200	1030803300
NERO CARAVAGGIO/BLACK		1030804001	1030804200	1030804300
MOKA/MOCHA		1030805001	1030805200	1030805300
ORO CALIFORNIA/GOLD		1030809001	1030809200	1030809300
ARAMEN/COPPER		1030810001	1030810200	1030810300
GRIGIO AVIO/GREY AVIO		1030811001	1030811200	1030811300
ARGENTO COMETA/SILVER COMET		1030812001	1030812200	1030812300
OTTONE VENEZIANO/BRASS		1030813001	1030813200	1030813300
TITANIO/TITANIUM		1030814001	1030814200	1030814300
BRONZO RIACI/RIACI BRONZE		1030815001	1030815200	1030815300
VERDE COSTA/GREEN COAST		1030816001	1030816200	1030816300
TERRA SENESE/SENESE EARTH		1030817001	1030817200	1030817300
CROMO/CHROME		1030808001	1030808200	

ATTENZIONE/PLEASE NOTE: LUNGHEZZA MASSIMA VERSIONE CROMO = 2,00 m / MAXIMUM LENGTH CHROME VERSION = 2.00 m
TESTATE DI CHIUSURA NON INCLUSE / DEAD ENDS NOT INCLUDED

u02

led integrato

integrated led

DATI TECNICI
TECHNICAL DATA

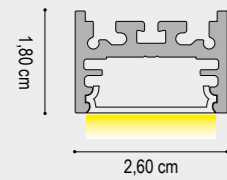

	1 cm - 2700K	1 cm - 3000K	1 cm - 4000K
Nominal LED Flux:	3680 lm/m	4000 lm/m	4160 lm/m
Flux Tot:	2944 lm/m	3200 lm/m	3328 lm/m
Output:	115 lm/W	125 lm/W	130 lm/W
CCT:	2700 K	3000 K	4000 K
CRI:	>90	>90	>90
Power Tot:	32.0 W/m	32.0 W/m	32.0 W/m
Weight:	0.50 Kg/m	0.50 Kg/m	0.50 Kg/m

Profilo/Profile: Alluminio/aluminum

Cover: Opale/opal

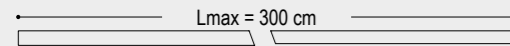

DRIVER NON INCLUSO / NOT INCLUDED

CAVO ALIMENTAZIONE: 50 cm
ALIMENTATION CABLE: 50 cm

FINITURA STRUTTURA FINISHES	DIFFUSORE DIFFUSER	1 cm - 2700K	1 cm - 3000K	1 cm - 4000K
		CODICE CODE	CODICE CODE	CODICE CODE
GRIGIO VESUVIO ANTHRACITE	OPALE/OPAL	103J200001	103J300001	103J400001
ARGILLA CLAY		103J201001	103J301001	103J401001
ARGENTO OPACO/MATT SILVER		103J202001	103J302001	103J402001
BIANCO INTONACO/WHITE		103J203001	103J303001	103J403001
NERO CARAVAGGIO/BLACK		103J204001	103J304001	103J404001
MOKA MOCHA		103J205001	103J305001	103J405001
CROMO/CHROME		103J208001	103J308001	103J408001
ORO CALIFORNIA/GOLD		103J209001	103J309001	103J409001
ARAMEN COPPER		103J210001	103J310001	103J410001
GRIGIO AVIO/ GREY AVIO		103J211001	103J311001	103J411001
ARGENTO COMETA/SILVER COMET		103J212001	103J312001	103J412001
OTTONE VENEZIANO/BRASS		103J213001	103J313001	103J413001
TITANIO/TITANIUM		103J214001	103J314001	103J414001
BRONZO RIACI/RIACI BRONZE		103J215001	103J315001	103J415001
VERDE COSTA/GREEN COAST		103J216001	103J316001	103J416001
TERRA SENESE/SENESE EARTH	103J217001	103J317001	103J417001	

N.B./P.N.:
LUNGHEZZA MASSIMA VERSIONE CROMO = 2,00 m / MAXIMUM LENGTH CHROME VERSION = 2.00 m
TESTATE NON INCLUSE / DEAD ENDS NOT INCLUDED

u02

led integrato

integrated led

DATI TECNICI
TECHNICAL DATA

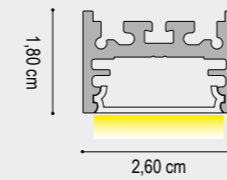

	1 cm
Nominal LED Flux:	2975 lm/m
Flux Tot:	2380 lm/m
Output:	125 lm/W
CCT:	3000 K
CRI:	>90
Power Tot:	24.0 W/m
Weight:	0.50 Kg/m

Profilo/Profile: Alluminio/aluminum
Cover: Opale/opal

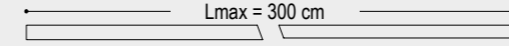

DRIVER NON INCLUSO / NOT INCLUDED

CAVO ALIMENTAZIONE: 50 cm
ALIMENTATION CABLE: 50 cm

FINITURA STRUTTURA FINISHES	DIFFUSORE DIFFUSER	1 cm - 2700K	1 cm - 3000K	1 cm - 4000K
		CODICE CODE	CODICE CODE	CODICE CODE
GRIGIO VESUVIO ANTHRACITE	OPALE/OPAL	103H600001	103H700001	103H800001
ARGILLA CLAY		103H601001	103H701001	103H801001
ARGENTO OPACO/MATT SILVER		103H602001	103H702001	103H802001
BIANCO INTONACO/WHITE		103H603001	103H703001	103H803001
NERO CARAVAGGIO/BLACK		103H604001	103H704001	103H804001
MOKA MOCHA		103H605001	103H705001	103H805001
CROMO/CHROME		103H608001	103H708001	103H808001
ORO CALIFORNIA/GOLD		103H609001	103H709001	103H809001
ARAMEN COPPER		103H610001	103H710001	103H810001
GRIGIO AVIO/ GREY AVIO		103H610301	103H710301	103H810301
ARGENTO COMETA/SILVER COMET		103H612001	103H712001	103H812001
OTTONE VENEZIANO/BRASS		103H613001	103H713001	103H813001
TITANIO/TITANIUM		103H614001	103H714001	103H814001
BRONZO RIACI/RIACI BRONZE		103H615001	103H715001	103H815001
VERDE COSTA/GREEN COAST		103H616001	103H716001	103H816001
TERRA SENESE/SENESE EARTH	103H617001	103H717001	103H817001	

N.B./P.N.:
LUNGHEZZA MASSIMA VERSIONE CROMO = 2,00 m / MAXIMUM LENGTH CHROME VERSION = 2.00 m
TESTATE NON INCLUSE / DEAD ENDS NOT INCLUDED



u02

led integrato

integrated led

DATI TECNICI
TECHNICAL DATA

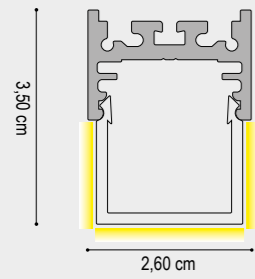

	1 cm	200 cm	300 cm
Nominal LED Flux:	1900 lm/m	3800 lm	5700 lm
Flux Tot:	1520 lm/m	3040 lm	4560 lm
Output:	158 lm/W	158 lm/W	158 lm/W
CCT:	3000 K	3000 K	3000 K
CRI:	>90	>90	>90
Power Tot:	12.0 W/m	24.0 W	36.0 W
Weight:	0.50 Kg/m	1.00 Kg	1.50 Kg

Profilo/Profile: Alluminio/aluminum Cover: Opale/opal

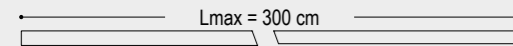

DRIVER NON INCLUSO / NOT INCLUDED

CAVO ALIMENTAZIONE: 50 cm
ALIMENTATION CABLE: 50 cm

DIFFUSORE OPALE QUADRATO

FINITURA STRUTTURA FINISHES	DIFFUSORE DIFFUSER	1 cm - 2700K CODICE CODE	1 cm - 3000K CODICE CODE	1 cm - 4000K CODICE CODE
GRIGIO VESUVIO ANTHRACITE	OPALE/OPAL	1035500201	1035500201	1035500201
ARGILLA CLAY		1035501201	1035501201	1035501201
ARGENTO OPACO/MATT SILVER		1035502201	1035502201	1035502201
BIANCO INTONACO/WHITE		1035503201	1035503201	1035503201
NERO CARAVAGGIO BLACK		1035504201	1035504201	1035504201
MOKA MOCHA		1035505201	1035505201	1035505201
CROMO/CHROME		1035508201	1035508201	1035508201
ORO CALIFORNIA/GOLD		1035509201	1035509201	1035509201
ARAMEN COPPER		1035510201	1035510201	1035510201
GRIGIO AVIO GREY AVIO		1035510301	1035510301	1035510301
ARGENTO COMETA/SILVER COMET		1035512201	1035512201	1035512201
OTTONE VENEZIANO BRASS		1035513201	1035513201	1035513201
TITANIO/TITANIUM		1035514201	1035514201	1035514201
BRONZO RIACI/RIACI BRONZE		1035515201	1035515201	1035515201
VERDE COSTA/GREEN COAST		1035516201	1035516201	1035516201
TERRA SENESE SENESE EARTH		1035517201	1035517201	1035517201

N.B./P.N.:
LUNGHEZZA MASSIMA VERSIONE CROMO = 2,00 m / MAXIMUM LENGTH CHROME VERSION = 2.00 m
TESTATE NON INCLUDE / DEAD ENDS NOT INCLUDED



u02

led integrato

integrated led

DATI TECNICI
TECHNICAL DATA

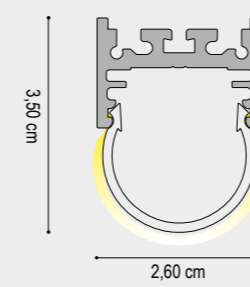

	1 cm	200 cm	300 cm
Nominal LED Flux:	1900 lm/m	3800 lm	5700 lm
Flux Tot:	1520 lm/m	3040 lm	4560 lm
Output:	158 lm/W	158 lm/W	158 lm/W
CCT:	3000 K	3000 K	3000 K
CRI:	>90	>90	>90
Power Tot:	12.0 W/m	24.0 W	36.0 W
Weight:	0.50 Kg/m	1.00 Kg	1.50 Kg

Profilo/Profile: Alluminio/aluminum Cover: Opale/opal

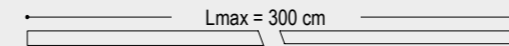

DRIVER NON INCLUSO / NOT INCLUDED

CAVO ALIMENTAZIONE: 50 cm
ALIMENTATION CABLE: 50 cm

DIFFUSORE OPALE TONDO

FINITURA STRUTTURA FINISHES	DIFFUSORE DIFFUSER	1 cm - 2700K CODICE CODE	1 cm - 3000K CODICE CODE	1 cm - 4000K CODICE CODE
GRIGIO VESUVIO ANTHRACITE	OPALE/OPAL	1035500401	1035500401	1035500401
ARGILLA CLAY		1035501401	1035501401	1035501401
ARGENTO OPACO/MATT SILVER		1035502401	1035502401	1035502401
BIANCO INTONACO/WHITE		1035503401	1035503401	1035503401
NERO CARAVAGGIO BLACK		1035504401	1035504401	1035504401
MOKA MOCHA		1035505401	1035505401	1035505401
CROMO/CHROME		1035508401	1035508401	1035508401
ORO CALIFORNIA/GOLD		1035509401	1035509401	1035509401
ARAMEN COPPER		1035510401	1035510401	1035510401
GRIGIO AVIO GREY AVIO		1035510301	1035510301	1035510301
ARGENTO COMETA/SILVER COMET		1035512401	1035512401	1035512401
OTTONE VENEZIANO BRASS		1035513401	1035513401	1035513401
TITANIO/TITANIUM		1035514401	1035514401	1035514401
BRONZO RIACI/RIACI BRONZE		1035515401	1035515401	1035515401
VERDE COSTA/GREEN COAST		1035516401	1035516401	1035516401
TERRA SENESE SENESE EARTH		1035517401	1035517401	1035517401

N.B./P.N.:
LUNGHEZZA MASSIMA VERSIONE CROMO = 2,00 m / MAXIMUM LENGTH CHROME VERSION = 2.00 m
TESTATE NON INCLUDE / DEAD ENDS NOT INCLUDED



u02

led integrato

integrated led

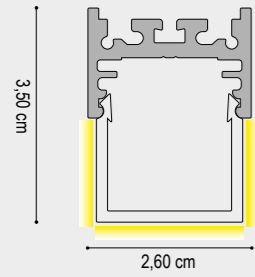

DATI TECNICI
TECHNICAL DATA

	1 cm
Nominal LED Flux:	2975 lm/m
Flux Tot:	2380 lm/m
Output:	125 lm/W
CCT:	3000 K
CRI:	>90
Power Tot:	24.0 W/m
Weight:	0.50 Kg/m
Profilo/Profile:	Alluminio/aluminum
Cover:	Opale/opal

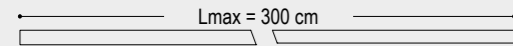

DRIVER NON INCLUSO / NOT INCLUDED

CAVO ALIMENTAZIONE: 50 cm
ALIMENTATION CABLE: 50 cm

DIFFUSORE OPALE QUADRATO

FINITURA STRUTTURA FINISHES	DIFFUSORE DIFFUSER	1 cm - 2700K	1 cm - 4000K	PREZZO PRICE
		CODICE CODE	CODICE CODE	
GRIGIO VESUVIO ANTHRACITE	OPALE/OPAL	103H600201	103H800201	€ 0,92
ARGILLA CLAY		103H601201	103H801201	€ 0,92
ARGENTO OPACO MATT SILVER		103H602201	103H802201	€ 0,91
BIANCO INTONACO/WHITE		103H603201	103H803201	€ 0,91
NERO CARAVAGGIO BLACK		103H604201	103H804201	€ 0,91
MOKA MOCHA		103H605201	103H805201	€ 0,92
CROMO CHROME		103H608201	103H808201	€ 1,15
ORO CALIFORNIA/GOLD		103H609201	103H809201	€ 0,95
ARAMEN COPPER		103H610201	103H810201	€ 1,15
GRIGIO AVIO GREY AVIO		103H611401	103H811401	€ 0,95
ARGENTO COMETA/SILVER COMET		103H612201	103H812201	€ 0,95
OTTONE VENEZIANO BRASS		103H613201	103H813201	€ 0,95
TITANIO/TITANIUM		103H614201	103H814201	€ 0,95
BRONZO RIACI/RIACI BRONZE		103H615201	103H815201	€ 0,95
VERDE COSTA/GREEN COAST		103H616201	103H816201	€ 0,95
TERRA SENESE/SENESE EARTH		103H617201	103H817201	€ 0,92

N.B./P.N.:
LUNGHEZZA MASSIMA VERSIONE CROMO = 2,00 m / MAXIMUM LENGTH CHROME VERSION = 2.00 m
TESTATE NON INCLUDE / DEAD ENDS NOT INCLUDED



u02

led integrato

integrated led

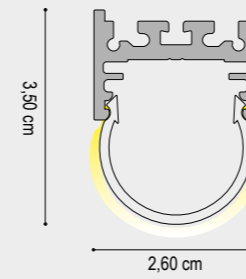

DATI TECNICI
TECHNICAL DATA

	1 cm
Nominal LED Flux:	2975 lm/m
Flux Tot:	2380 lm/m
Output:	125 lm/W
CCT:	3000 K
CRI:	>90
Power Tot:	24.0 W/m
Weight:	0.50 Kg/m
Profilo/Profile:	Alluminio/aluminum
Cover:	Opale/opal

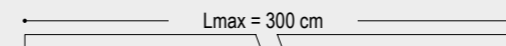

DRIVER NON INCLUSO / NOT INCLUDED

CAVO ALIMENTAZIONE: 50 cm
ALIMENTATION CABLE: 50 cm

DIFFUSORE OPALE TONDO

FINITURA STRUTTURA FINISHES	DIFFUSORE DIFFUSER	1 cm - 2700K	1 cm - 3000K	1 cm - 4000K
		CODICE CODE	CODICE CODE	CODICE CODE
GRIGIO VESUVIO ANTHRACITE	OPALE/OPAL	103H600401	103H700401	103H800401
ARGILLA CLAY		103H601401	103H701401	103H801401
ARGENTO OPACO MATT SILVER		103H602401	103H702401	103H802401
BIANCO INTONACO/WHITE		103H603401	103H703401	103H803401
NERO CARAVAGGIO BLACK		103H604401	103H704401	103H804401
MOKA MOCHA		103H605401	103H705401	103H805401
CROMO CHROME		103H608401	103H708401	103H808401
ORO CALIFORNIA/GOLD		103H609401	103H709401	103H809401
ARAMEN COPPER		103H610401	103H710401	103H810401
GRIGIO AVIO GREY AVIO		103H611401	103H711401	103H811401
ARGENTO COMETA/SILVER COMET		103H612401	103H712401	103H812401
OTTONE VENEZIANO BRASS		103H613401	103H713401	103H813401
TITANIO/TITANIUM		103H614401	103H714401	103H814401
BRONZO RIACI/RIACI BRONZE		103H615401	103H715401	103H815401
VERDE COSTA/GREEN COAST		103H616401	103H716401	103H816401
TERRA SENESE/SENESE EARTH		103H617401	103H717401	103H817401

N.B./P.N.:
LUNGHEZZA MASSIMA VERSIONE CROMO = 2,00 m / MAXIMUM LENGTH CHROME VERSION = 2.00 m
TESTATE NON INCLUDE / DEAD ENDS NOT INCLUDED



u02

profilo

profile

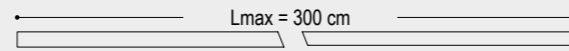
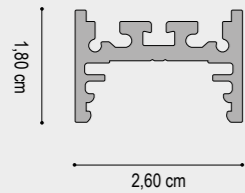

FINITURA STRUTTURA FINISHES

- GRIGIO VESUVIO/ANTHRACITE
- ARGILLA/ARGIL
- ARGENTO OPACO/MATT SILVER
- BIANCO INTONACO/WHITE
- NERO CARAVAGGIO/BLACK
- MOKA/MOCHA
- ALLUMINIO NATURALE/ALUMINUM
- ORO CALIFORNIA/GOLD
- ARAMEN/COPPER
- GRIGIO AVIO/GREY AVIO
- ARGENTO COMETA/SILVER COMET
- OTTONE VENEZIANO/BRASS
- TITANIO/TITANIUM
- BRONZO RIACI/RIACI BRONZE
- VERDE COSTA/GREEN COAST
- TERRA SENESE/SENESE EARTH
- CROMO/CHROME

	1 cm	200 cm	300 cm
CODICE CODE	CODICE CODE	CODICE CODE	CODICE CODE
	103030001	103030020	103030030
	103030101	103030120	103030130
	103030201	103030220	103030230
	103030301	103030320	103030330
	103030401	103030420	103030430
	103030501	103030520	103030530
	103030501	103030620	103030630
	103030901	103030920	103030930
	103031001	103031020	103031030
	103031101	103031120	103031130
	103031201	103031220	103031230
	103031301	103031320	103031330
	103031401	103031420	103031430
	103031501	103031520	103031530
	103031601	103031620	103031630
	103031701	103031720	103031730
	103030801	103030820	

ATTENZIONE/PLEASE NOTE: LUNGHEZZA MASSIMA VERSIONE CROMO = 2,00 m / MAXIMUM LENGTH CHROME VERSION = 2.00 m
TESTATE DI CHIUSURA NON INCLUSE / DEAD ENDS NOT INCLUDED

LED compatibili / LED compatibility

HIGH QUALITY CRI>90 CRI>95	HIGH OUTPUT CRI>90 CRI>95	HIGH EFFICIENT CRI>90 CRI>95	HIGH INTENSITY CRI>90 CRI>95	LOW POWER CRI>90	ULTRA SLIM CRI>90 CRI>95 CRI>97	RGB	RGB WHITE	RGB TW	TUNABLE WHITE
9,6W 14,4W 19,2W	12,3W 14,4W 19,2W 20W 24W	12,3W 14,4W 19,2W 20W 24W	24W 24W (700 LED)	6W	9,6W 12W 14,4W	14W	14W	14,4W 23W	19,2W



u02

accessori

accessories

DIFFUSORE

		1 cm	200 cm	300 cm
	DIFFUSORE DIFFUSER	CODICE CODE	CODICE CODE	CODICE CODE
	OPALE/OPAL	103010001	103010020	103010030
	SATINATA/SATIN	103010101	103010120	103010130
	PRISMATIZZATO/PRISMATIC	1030113001	1030113200	1030113300
	OPALE/OPAL	103011001	103011020	103011030
	SATINATA/SATIN	103011101	103011120	103011130
	OPALE/OPAL	103012001	103012020	103012030
	SATINATA/SATIN	103012101	103012120	103012130

LENTE 65°

		1 cm	200 cm
	DIFFUSORE DIFFUSER	CODICE CODE	CODICE CODE
	LENTE 65°/LENS 65°	1040245001	1040245200

COVER ALLUMINIO / ALUMINUM COVER



	1 cm	1 cm
FINITURA STRUTTURA FINISHES	CODICE CODE	FINITURA STRUTTURA FINISHES
GRIGIO VESUVIO ANTHRACITE	103CM00001	ARAMEN COPPER
ARGILLA CLAY	103CM01001	GRIGIO AVIO/GREY AVIO
ARGENTO OPACO MATT SILVER	103CM02001	ARGENTO COMETA/SILVER COMET
BIANCO INTONACO/WHITE	103CM03001	OTTONE VENEZIANO BRASS
NERO CARAVAGGIO BLACK	103CM04001	TITANIO/TITANIUM
MOKA MOCHA	103CM05001	BRONZO RIACI/RIACI BRONZE
CROMO/CHROME	103CM08001	VERDE COSTA/GREEN COAST
ORO CALIFORNIA/GOLD	103CM09001	TERRA SENESE/SENESE EARTH

TESTATE DI CHIUSURA / DEAD ENDS

FINITURA STRUTTURA FINISHES	CODICE CODE	PREZZO PRICE	FINITURA STRUTTURA FINISHES	CODICE CODE
GRIGIO VESUVIO/ANTHRACITE	1030400000	€ 5,20	ARAMEN/COPPER	1030410000
ARGILLA/ARGIL	1030401000	€ 5,20	GRIGIO AVIO/GREY AVIO	1030411000
ARGENTO OPACO/MATT SILVER	1030402000	€ 5,20	ARGENTO COMETA/SILVER COMET	1030412000
BIANCO INTONACO/WHITE	1030403000	€ 5,20	OTTONE VENEZIANO/BRASS	1030413000
NERO CARAVAGGIO/BLACK	1030404000	€ 5,20	TITANIO/TITANIUM	1030414000
MOKA/MOCHA	1030405000	€ 5,20	BRONZO RIACI/RIACI BRONZE	1030415000
ALLUMINIO NATURALE/ALUMINUM	1030406000	€ 4,20	VERDE COSTA/GREEN COAST	1030416000
CROMO/CHROME	1030408000	€ 6,00	TERRA SENESE/SENESE EARTH	1030417000
ORO CALIFORNIA/GOLD	1030409000	€ 5,50		

Nel codice sono comprese le viti per il fissaggio delle testate al profilo. Il codice contiene n° 1 testate di chiusura. / The code includes the screws for fixing the heads to the profile. The code contains 1 closing warheads

TESTATE DI CHIUSURA QUADRATA / SQUARE DEAD ENDS

FINITURA STRUTTURA FINISHES	CODICE CODE	PREZZO PRICE	FINITURA STRUTTURA FINISHES	CODICE CODE
GRIGIO VESUVIO/ANTHRACITE	1030500000	€ 6,80	ARAMEN/COPPER	1030510000
ARGILLA/ARGIL	1030501000	€ 6,80	GRIGIO AVIO/GREY AVIO	1030511000
ARGENTO OPACO/MATT SILVER	1030502000	€ 6,80	ARGENTO COMETA/SILVER COMET	1030512000
BIANCO INTONACO/WHITE	1030503000	€ 6,80	OTTONE VENEZIANO/BRASS	1030513000
NERO CARAVAGGIO/BLACK	1030504000	€ 6,80	TITANIO/TITANIUM	1030514000
MOKA/MOCHA	1030505000	€ 6,80	BRONZO RIACI/RIACI BRONZE	1030515000
ALLUMINIO NATURALE/ALUMINUM	1030506000	€ 5,60	VERDE COSTA/GREEN COAST	1030516000
CROMO/CHROME	1030508000	€ 7,60	TERRA SENESE/SENESE EARTH	1030517000
ORO CALIFORNIA/GOLD	1030509000	€ 7,10		

Nel codice sono comprese le viti per il fissaggio delle testate al profilo. Il codice contiene n° 1 testate di chiusura. / The code includes the screws for fixing the heads to the profile. The code contains 1 closing warheads

TESTATE DI CHIUSURA QUADRATA / SQUARE DEAD ENDS

FINITURA STRUTTURA FINISHES	CODICE CODE	PREZZO PRICE	FINITURA STRUTTURA FINISHES	CODICE CODE
GRIGIO VESUVIO/ANTHRACITE	1030700000	€ 6,80	ARAMEN/COPPER	1030710000
ARGILLA/ARGIL	1030701000	€ 6,80	GRIGIO AVIO/GREY AVIO	1030711000
ARGENTO OPACO/MATT SILVER	1030702000	€ 6,80	ARGENTO COMETA/SILVER COMET	1030712000
BIANCO INTONACO/WHITE	1030703000	€ 6,80	OTTONE VENEZIANO/BRASS	1030713000
NERO CARAVAGGIO/BLACK	1030704000	€ 6,80	TITANIO/TITANIUM	1030714000
MOKA/MOCHA	1030705000	€ 6,80	BRONZO RIACI/RIACI BRONZE	1030715000
ALLUMINIO NATURALE/ALUMINUM	1030706000	€ 5,60	VERDE COSTA/GREEN COAST	1030716000
CROMO/CHROME	1030708000	€ 7,60	TERRA SENESE/SENESE EARTH	1030717000
ORO CALIFORNIA/GOLD	1030709000	€ 7,10		

Nel codice sono comprese le viti per il fissaggio delle testate al profilo. Il codice contiene n° 1 testate di chiusura. / The code includes the screws for fixing the heads to the profile. The code contains 1 closing warheads

TESTATE DI CHIUSURA QUADRATA / SQUARE DEAD ENDS

FINITURA STRUTTURA FINISHES	CODICE CODE	FINITURA STRUTTURA FINISHES	CODICE CODE
GRIGIO VESUVIO/ANTHRACITE	1030600000	ARAMEN/COPPER	1030610000
ARGILLA/ARGIL	1030601000	GRIGIO AVIO/GREY AVIO	1030611000
ARGENTO OPACO/MATT SILVER	1030602000	ARGENTO COMETA/SILVER COMET	1030612000
BIANCO INTONACO/WHITE	1030603000	OTTONE VENEZIANO/BRASS	1030613000
NERO CARAVAGGIO/BLACK	1030604000	TITANIO/TITANIUM	1030614000
MOKA/MOCHA	1030605000	BRONZO RIACI/RIACI BRONZE	1030615000
ALLUMINIO NATURALE/ALUMINUM	1030606000	VERDE COSTA/GREEN COAST	1030616000
CROMO/CHROME	1030608000	TERRA SENESE/SENESE EARTH	1030617000
ORO CALIFORNIA/GOLD	1030609000		

Nel codice sono comprese le viti per il fissaggio delle testate al profilo. Il codice contiene n° 1 testate di chiusura. / The code includes the screws for fixing the heads to the profile. The code contains 1 closing warheads

TESTATE DI CHIUSURA QUADRATA / SQUARE DEAD ENDS

FINITURA STRUTTURA FINISHES	CODICE CODE	PREZZO PRICE	FINITURA STRUTTURA FINISHES	CODICE CODE
GRIGIO VESUVIO/ANTHRACITE	1030800000	€ 6,80	ARAMEN/COPPER	1030810000
ARGILLA/ARGIL	1030801000	€ 6,80	GRIGIO AVIO/GREY AVIO	1030811000
ARGENTO OPACO/MATT SILVER	1030802000	€ 6,80	ARGENTO COMETA/SILVER COMET	1030812000
BIANCO INTONACO/WHITE	1030803000	€ 6,80	OTTONE VENEZIANO/BRASS	1030813000
NERO CARAVAGGIO/BLACK	1030804000	€ 6,80	TITANIO/TITANIUM	1030814000
MOKA/MOCHA	1030805000	€ 6,80	BRONZO RIACI/RIACI BRONZE	1030815000
ALLUMINIO NATURALE/ALUMINUM	1030806000	€ 5,60	VERDE COSTA/GREEN COAST	1030816000
CROMO/CHROME	1030808000	€ 7,60	TERRA SENESE/SENESE EARTH	1030817000
ORO CALIFORNIA/GOLD	1030809000	€ 7,10		

Nel codice sono comprese le viti per il fissaggio delle testate al profilo. Il codice contiene n° 1 testate di chiusura. / The code includes the screws for fixing the heads to the profile. The code contains 1 closing warheads

VERSIONE KIT / KIT VERSION

DATI TECNICI TECHNICAL DATA	FINITURA FINISHES	DIFFUSORE DIFFUSER	200 cm	300 cm
			CODICE CODE	CODICE CODE
ARTICOLI INCLUSI NEL CODICE ARTICLES INCLUDED IN THE CODE N°2 testate di chiusura / No. 2 closing heads N°4 staffe di fissaggio h3mm - Versione 200cm N°4 fixing brackets h3mm - Type 200cm N°6 staffe di fissaggio h3mm - Versione 300cm N°6 fixing brackets h3mm - Type 300cm	ALLUMINIO NATURALE/ALUMINUM	OPALE/OPAL	103P22	103P32
	NERO CARAVAGGIO/BLACK		103P23	103P33
			103P24	103P34
	ALLUMINIO NATURALE/ALUMINUM	SATINATA/SATIN	103S22	103S22
	BIANCO INTONACO/WHITE		103S23	103S23
	NERO CARAVAGGIO/BLACK		103S24	103S24

STAFFA DI FISSAGGIO / MOUNTING CLIP

FINITURA FINISHES	CODICE CODE
SUPERFICI PIANE 2mm EVEN SURFACE 2mm	102050003
SUPERFICI IRREGOLARI 3,5mm UNEVEN SURFACE 3,5mm	102050004

Accessorio per fissaggio a plafone/superficie. Quantità raccomandata: 1 pz ogni 50 cm di profilo
Ceiling/surface mounting accessory. Recommended quantity: 1 pc every 50 cm of profile

CALAMITA / MAGNET

CODICE CODE	PORTATA RANGE
102050001	1 Kg
1020500210	2 Kg

Quantità raccomandata: 1 pz ogni 25cm di profilo
Recommended quantity: 1 pc every 25cm of profile

KIT DI SOSPENSIONE / SUSPENSION KIT

**DATI TECNICI
TECHNICAL DATA**

ARTICOLI INCLUSI NEL CODICE
ARTICLES INCLUDED IN THE CODE

Cavo in acciaio 2,00m con puntalino
2.00m steel cable with tip
Boccola cromata con regolazione millimetrica
Chrome bush with millimeter adjustment
Archetto in alluminio per sospensione
Aluminum arch for suspension

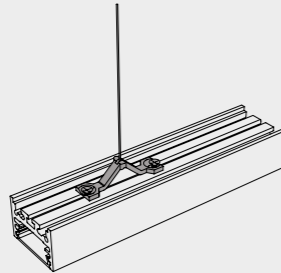

**FINITURA STRUTTURA
FINISHES**

GRIGIO VESUVIO/ANTHRACITE
ARGILLA/ARGIL
ARGENTO OPACO/MATT SILVER
BIANCO INTONACO/WHITE
NERO CARAVAGGIO/BLACK
MOKA/MOCHA
CROMO/CHROME
ORO CALIFORNIA/GOLD
ARAMEN/COPPER
ARGENTO COMETA/SILVER COMET
OTTONE VENEZIANO/BRASS
TITANIO/TITANIUM
BRONZO RIACI/RIACI BRONZE
VERDE COSTA/GREEN COAST
TERRA SENESE/SENESE EARTH

**CODICE
CODE**

1040500004
1040501004
1040502004
1040503004
1040504004
1040505004
1040508004
1040509004
1040510004
1030712004
1030713004
1090714004
1090715004
1090716004
1040517004

STAFFA DI FISSAGGIO A PARETE / WALL MOUNTING CLIP

**DATI TECNICI
TECHNICAL DATA**

MATERIALE: Alluminio naturale
MATERIAL: Natural aluminum

Nel codice è compresa la vite per il fissaggio della staffa al profilo
The code includes the screw for fixing the bracket to the profile

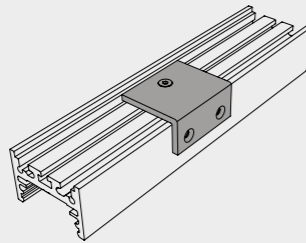

**FINITURA STRUTTURA
FINISHES**

GRIGIO VESUVIO/ANTHRACITE
ARGILLA/ARGIL
ARGENTO OPACO/MATT SILVER
BIANCO INTONACO/WHITE
NERO CARAVAGGIO/BLACK
MOKA/MOCHA
CROMO/CHROME
ORO CALIFORNIA/GOLD
ARAMEN/COPPER
GRIGIO AVIO/GREY AVIO
ARGENTO COMETA/SILVER COMET
OTTONE VENEZIANO/BRASS
TITANIO/TITANIUM
BRONZO RIACI/RIACI BRONZE
VERDE COSTA/GREEN COAST
TERRA SENESE/SENESE EARTH

**CODICE
CODE**

1030500003
1030501003
1030502003
1030503003
1030504003
1030505003
1030508003
1030509003
1030510003
1030511003
1030512003
1030513003
1030514003
1030515003
1030516003
1030517003

STAFFA A PARETE REGOLABILE / ADJUSTABLE WALL BRACKET

**DATI TECNICI
TECHNICAL DATA**

MATERIALE: Alluminio naturale
MATERIAL: Natural aluminum

ARTICOLI INCLUSI NEL CODICE
ARTICLES INCLUDED IN THE CODE

N°1 staffa regolabile in alluminio
N° 1 adjustable aluminum bracket
Viti per il fissaggio
Screws for fixing

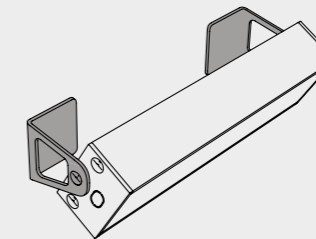

**FINITURA STRUTTURA
FINISHES**

GRIGIO VESUVIO/ANTHRACITE
ARGILLA/ARGIL
ARGENTO OPACO/MATT SILVER
BIANCO INTONACO/WHITE
NERO CARAVAGGIO/BLACK
MOKA/MOCHA
CROMO/CHROME
ORO CALIFORNIA/GOLD
ARAMEN/COPPER
GRIGIO AVIO/GREY AVIO
ARGENTO COMETA/SILVER COMET
OTTONE VENEZIANO/BRASS
TITANIO/TITANIUM
BRONZO RIACI/RIACI BRONZE
VERDE COSTA/GREEN COAST
TERRA SENESE/SENESE EARTH

**CODICE
CODE**

1030500005
1030501005
1030502005
1030503005
1030504005
1030505005
1030508005
1030509005
1030510005
1030511005
1030512005
1030513005
1030514005
1030515005
1030516005
1030517005

STAFFA INCASSO CARTONGESSO / PLASTERBOARD RECESSED BRACKET

**DATI TECNICI
TECHNICAL DATA**

ARTICOLI INCLUSI NEL CODICE
ARTICLES INCLUDED IN THE CODE

Clip di fissaggio in policarbonato 3mm
Fixing clip in 3mm polycarbonate
Viti per il fissaggio del profilo alla staffa
Screws for fixing the profile to the bracket

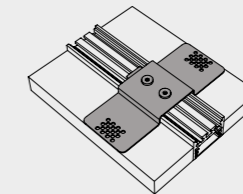

**FINITURA STRUTTURA
FINISHES**

ALLUMINIO NATURALE/ALUMINUM

**CODICE
CODE**

1030500002

GIUNTI / JOINTS

GIUNTO LINEA CONTINUA / STRAIGHT JOINT
Accessorio per giunzioni meccaniche lineari
Accessory for linear mechanical joints



ALLUMINIO NATURALE/ALUMINUM

1010500006

GIUNTO 90° ORIZZONTALE / HORIZONTAL JOINT 90°
Accessorio per giunzioni meccaniche con angolo 90°
Accessory for linear mechanical joints with 90° angle

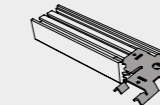

ALLUMINIO NATURALE/ALUMINUM

1030500006

GIUNTO 90° VERTICALE / VERTICAL JOINT 90°
Accessorio per giunzioni meccaniche con angolo 90°
Accessory for linear mechanical joints with 90° angle

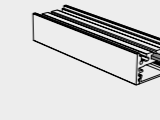

ALLUMINIO NATURALE/ALUMINUM

1010500007

Nel codice sono compresi i grani per il fissaggio del giunto / The code includes the grains for fixing the joint.

u02 point



u02 point

DATI TECNICI
TECHNICAL DATA

	35 cm	70 cm	105 cm	120 cm
Nominal SPOT Flux:	2178 lm	3267 lm	4356 lm	5445 lm
Flux Tot:	1742 lm	2614 lm	3485 lm	4356 lm
Output:	121 lm/W	121 lm/W	121 lm/W	121 lm/W
CCT:	3000 K	3000 K	3000 K	3000 K
CRI:	>90	>90	>90	>90
SPOT Power Tot:	18.0W (3W x 6)	27.0W (3W x 9)	36.0W (3W x 12)	45.0W (3W x 15)
Weight:	0.60 Kg	1.20 Kg	1.80 Kg	2.10 Kg

Profilo/Profile: Alluminio/aluminum

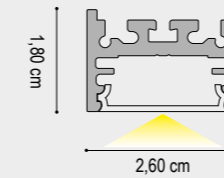

ARTICOLI INCLUSI NEL CODICE:
ITEMS INCLUDED IN THE CODE:
ALIMENTATORE ON/OFF REMOTO / REMOTE POWER SUPPLY ON/OFF
COPPIA DI TESTATE DI CHIUSURA / PAIR OF CLOSING HEADS

FINITURA STRUTTURA FINISHES	35 cm	70 cm	105 cm	120 cm
GRIGIO VESUVIO/ANTHRACITE	1038400035	1038400070	1038400105	1038400120
ARGILLA/ARGIL	1038401035	1038401070	1038401105	1038401120
ARGENTO OPACO/MATT SILVER	1038402035	1038402070	1038402105	1038402120
BIANCO INTONACO/WHITE	1038403035	1038403070	1038403105	1038403120
NERO CARAVAGGIO/BLACK	1038404035	1038404070	1038404105	1038404120
MOKA/MOCHA	1038405035	1038405070	1038405105	1038405120
CROMO/CHROME	1038408035	1038408070	1038408105	1038408120
ORO CALIFORNIA/GOLD	1038409035	1038409070	1038409105	1038409120
ARAMEN/COPPER	1038410035	1038410070	1038410105	1038410120
GRIGIO AVIO/GREY AVIO	1038411035	1038411070	1038411105	1038411120
ARGENTO COMETA/SILVER COMET	1038412035	1038412070	1038412105	1038412120
OTTONE VENEZIANO/BRASS	1038413035	1038413070	1038413105	1038413120
TITANIO/TITANIUM	1038414035	1038414070	1038414105	1038414120
BRONZO RIACI/RIACI BRONZE	1038415035	1038415070	1038415105	1038415120
VERDE COSTA/GREEN COAST	1038415035	1038415070	1038415105	1038415120
TERRA SENESE/SENESE EARTH	1038417035	1038417070	1038417105	1038417120

ATTENZIONE/PLEASE NOTE:
LUNGHEZZA MASSIMA VERSIONE CROMO = 2,00 m / MAXIMUM LENGTH CHROME VERSION = 2.00 m

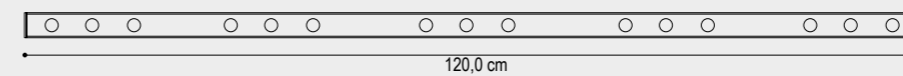
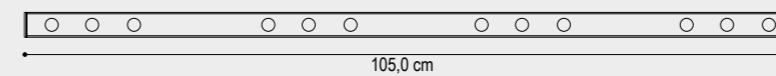
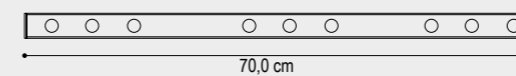
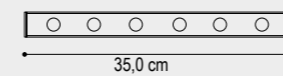

INTERRUTTORE DIMMERABILE / DIMMABLE SWITCH

DATI TECNICI
TECHNICAL DATA

Accessorio che consente l'accensione e lo spegnimento dei LED e, a seconda della pressione, la regolazione dell'intensità luminosa.
Accessory that allows the switching on and off of the LEDs and, depending on the pressure, the regulation of the light intensity.

Tensione di alimentazione: 12-24V DC
Supply voltage: 12-24V DC
Corrente d'uscita: 4A max
Output current: 4A max
ON / OFF: contact < 0.7 s
DIMMER: contact > 0.7 s

FINITURA STRUTTURA
FINISHES

ALLUMINIO NATURALE/ALUMINUM

CODICE
CODE

98243

INTERRUTTORE DIMMERABILE+INSTALLAZIONE / DIMMABLE SWITCH+INSTALLATION

DATI TECNICI
TECHNICAL DATA

Accessorio che consente l'accensione e lo spegnimento dei LED e, a seconda della pressione, la regolazione dell'intensità luminosa.
Accessory that allows the switching on and off of the LEDs and, depending on the pressure, the regulation of the light intensity.

Tensione di alimentazione: 12-24V DC
Supply voltage: 12-24V DC
Corrente d'uscita: 4A max
Output current: 4A max
ON / OFF: contact < 0.7 s
DIMMER: contact > 0.7 s

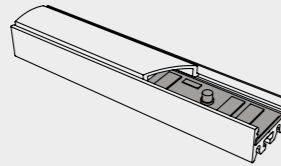
FINITURA STRUTTURA
FINISHES

ALLUMINIO NATURALE/ALUMINUM

CODICE
CODE

98244

LAVORAZIONI / PROCESSING

DATI TECNICI
TECHNICAL DATA

TAGLIO 90° ORIZZONTALE (PER ANGOLI FORMATI DA DUE PROFILI)
HORIZONTAL 90° CUT (FOR CORNERS MADE OF TWO PROFILES)

CODICE
CODE

190X



TAGLIO 90° VERTICALE (PER ANGOLI FORMATI DA DUE PROFILI)
VERTICAL 90° CUT (FOR CORNERS MADE OF TWO PROFILES)

190Y



TAGLIO ANGOLARE CUSTOM (PER ANGOLI FORMATI DA DUE PROFILI)
CUSTOM CORNER CUT (FOR CORNERS MADE OF TWO PROFILES)

190N

ASOLA / SLOT

100A

ASOLA CUSTOM / SLOT CUSTOM

100N

FORO / HOLE

100F



CABLAGGIO - COLLAUDO - CE AL CENTIMETRO
INSTALLATION AND TESTING LED MODULE AT CENTIMETER

1031

CABLAGGIO - COLLAUDO CE - MONTAGGIO LED IP AL CENTIMETRO
INSTALLATION - TESTING LED CE - ASSEMBLY LED IP AT CENTIMETER

1016



CONNETTORE MASCHIO/FEMMINA
MALE/FEMALE CONNECTOR

98CFM

CONNETTORE MASCHIO/FEMMINA MONTATO NEL PRODOTTO
MALE/FEMALE CONNECTOR FITTED IN THE PRODUCT

98MFM



CAVO DI ALIMENTAZIONE 2X0,75 TONDO TRASPARENTE 1CM
POWER CABLE 2X0,75 ROUND TRANSPARENT 1CM

98CTT001



“massima espressione tecnologica”

U03, le dimensioni non contano...Non sempre piccolo è sinonimo di inefficienza; nel nostro profilo U03 è racchiusa la massima espressione tecnologica dell'estruzione dell'alluminio finalizzata alla dissipazione termica. Luce morbida e diffusa grazie alla cover dedicata in policarbonato. Linee pulite ed essenziali.

U03, dimensions doesn't matter...Small is not always synonym for inefficiency, in our U03 profile is contained the highest expression of technology aimed at the aluminum extrusion heat dissipation. Soft and diff used light thanks to dedicated polycarbonate cover. Clean and essential lines.





ATTENZIONE! GLI ACCESSORI PER L'INSTALLAZIONE A INCASSO SONO STATI DIMENSIONATI PER UN PANNELLO STANDARD IN CARTONGESSO DI SPESSORE 12,5 mm
 WARNING! THE BUILT-IN INSTALLATION ACCESSORIES HAVE BEEN DIMENSIONED FOR A STANDARD PLASTERBOARD PANEL OF 12.5 mm THICKNESS

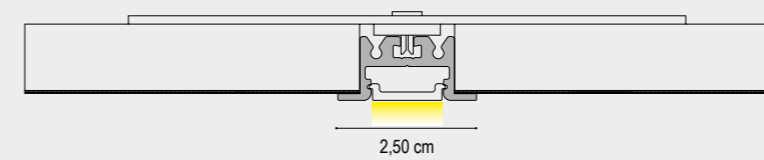

INSTALLAZIONE CON STAFFA PER INCASSO A CARTONGESSO
 INSTALLATION WITH BUILT-IN BRACKET

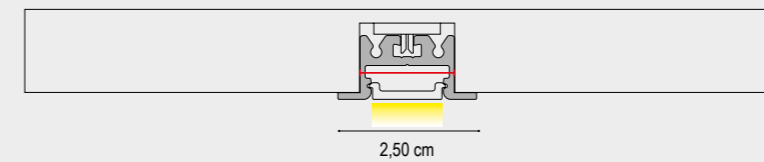

INSTALLAZIONE AD INCASSO CON CLIP IN POLICARBONATO IN MENSOLA
 BUILT-IN INSTALLATION WITH SHELF IN POLYCARBONATE



INSTALLAZIONE AD INCASSO
 LARGHEZZA TAGLIO L=1,70cm
 RECESSED INSTALLATION
 CUTTING WIDTH L=1,70cm



1. SOFFITTO/PARETE - ANGOLO 90° VERTICALE
 1. CEILING/WALL VERTICAL 90° CORNER

ACCESSORI E LAVORAZIONI
ACCESSORIES AND PROCESSING

GIUNTO MECCANICO / MECHANICAL JOINT
 CODICE / CODE: 1010500007

STAFFA A INCASSO / RECESSED BRACKET
 CODICE / CODE: 1090500001

TAGLIO ANGOLARE / CORNER CUT
 CODICE / CODE: 190Y



2. SOFFITTO - ANGOLO 90° ORIZZONTALE
 2. CEILING - HORIZONTAL 90° CORNER

ACCESSORI E LAVORAZIONI
ACCESSORIES AND PROCESSING

GIUNTO MECCANICO / MECHANICAL JOINT
 CODICE / CODE: 1010500005

STAFFA A INCASSO / RECESSED BRACKET
 CODICE / CODE: 1090500001

TAGLIO ANGOLARE / CORNER CUT
 CODICE / CODE: 190X



3. PARETE - ANGOLO 90° VERTICALE
 3. WALL - VERTICAL 90° CORNER

ACCESSORI E LAVORAZIONI
ACCESSORIES AND PROCESSING

GIUNTO MECCANICO / MECHANICAL JOINT
 CODICE / CODE: 1010500007

STAFFA A INCASSO / RECESSED BRACKET
 CODICE / CODE: 1090500001

TAGLIO ANGOLARE / CORNER CUT
 CODICE / CODE: 190Y

u03

led integrato

integrated led

DATI TECNICI
TECHNICAL DATA

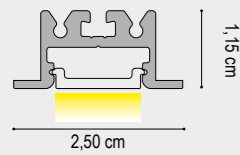

	1 cm	200 cm	300 cm
Nominal LED Flux:	1200 lm/m	2400 lm	3600 lm
Flux Tot:	960 lm/m	1920 lm	2880 lm
Output:	85 lm/W	85 lm/W	85 lm/W
CCT:	3000 K	3000 K	3000 K
CRI:	>90	>90	>90
Power Tot:	14.4 W/m	28.8 W	43.2 W
Weight:	0.40 Kg/m	0.80 Kg	1.20 Kg

Profilo/Profile: Alluminio/aluminum

Cover: Opale/opal

Lmax = 300 cm

DRIVER NON INCLUSO / NOT INCLUDED

CAVO ALIMENTAZIONE: 50 cm
ALIMENTATION CABLE: 50 cm

1 cm 200 cm 300 cm

FINITURA STRUTTURA
FINISHES

- GRIGIO VESUVIO/ANTHRACITE
- ARGILLA/ARGIL
- ARGENTO OPACO/MATT SILVER
- BIANCO INTONACO/WHITE
- NERO CARAVAGGIO/BLACK
- MOKA/MOCHA
- ORO CALIFORNIA/GOLD
- ARAMEN/COPPER
- ARGENTO COMETA/SILVER COMET
- OTTONE VENEZIANO/BRASS
- TITANIO/TITANIUM
- BRONZO RIACI/RIACI BRONZE
- VERDE COSTA/GREEN COAST
- TERRA SENESE/SENESE EARTH
- CROMO/CHROME

DIFFUSORE
DIFFUSER

OPALE/OPAL

CODICE CODE	CODICE CODE	CODICE CODE
114050001	1140500200	1140500300
1140501001	1140501200	1140501300
1140502001	1140502200	1140502300
1140503001	1140503200	1140503300
1140504001	1140504200	1140504300
1140505001	1140505200	1140505300
1140509001	1140509200	1140509300
1140510001	1140510200	1140510300
1140512001	1140512200	1140512300
1140513001	1140513200	1140513300
1140514001	1140514200	1140514300
1140515001	1140515200	1140515300
1140516001	1140516200	1140516300
1140517001	1140517200	1140517300
1140508001	1140508200	

ATTENZIONE/PLEASE NOTE: LUNGHEZZA MASSIMA VERSIONE CROMO = 2,00 m / MAXIMUM LENGTH CHROME VERSION = 2.00 m
TESTATE DI CHIUSURA NON INCLUSE / DEAD ENDS NOT INCLUDED



u03

led integrato

integrated led

DATI TECNICI
TECHNICAL DATA

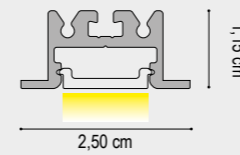

	1 cm	200 cm	300 cm
Nominal LED Flux:	1600 lm/m	3200 lm	4800 lm
Flux Tot:	1280 lm/m	2560 lm	3840 lm
Output:	85 lm/W	85 lm/W	85 lm/W
CCT:	3000 K	3000 K	3000 K
CRI:	>90	>90	>90
Power Tot:	19.2 W/m	38.4 W	57.6 W
Weight:	0.40 Kg/m	0.80 Kg	1.20 Kg

Profilo/Profile: Alluminio/aluminum

Cover: Opale/opal

Lmax = 300 cm

DRIVER NON INCLUSO / NOT INCLUDED

CAVO ALIMENTAZIONE: 50 cm
ALIMENTATION CABLE: 50 cm

1 cm 200 cm 300 cm

FINITURA STRUTTURA
FINISHES

- GRIGIO VESUVIO/ANTHRACITE
- ARGILLA/ARGIL
- ARGENTO OPACO/MATT SILVER
- BIANCO INTONACO/WHITE
- NERO CARAVAGGIO/BLACK
- MOKA/MOCHA
- ORO CALIFORNIA/GOLD
- ARAMEN/COPPER
- ARGENTO COMETA/SILVER COMET
- OTTONE VENEZIANO/BRASS
- TITANIO/TITANIUM
- BRONZO RIACI/RIACI BRONZE
- VERDE COSTA/GREEN COAST
- TERRA SENESE/SENESE EARTH
- CROMO/CHROME

DIFFUSORE
DIFFUSER

OPALE/OPAL

CODICE CODE	CODICE CODE	CODICE CODE
114080001	1140800200	1140800300
1140801001	1140801200	1140801300
1140802001	1140802200	1140802300
1140803001	1140803200	1140803300
1140804001	1140804200	1140804300
1140805001	1140805200	1140805300
1140809001	1140809200	1140809300
1140810001	1140810200	1140810300
1140812001	1140812200	1140812300
1140813001	1140813200	1140813300
1140814001	1140814200	1140814300
1140815001	1140815200	1140815300
1140816001	1140816200	1140816300
1140817001	1140817200	1140817300
1140808001	1140808200	

ATTENZIONE/PLEASE NOTE: LUNGHEZZA MASSIMA VERSIONE CROMO = 2,00 m / MAXIMUM LENGTH CHROME VERSION = 2.00 m
TESTATE DI CHIUSURA NON INCLUSE / DEAD ENDS NOT INCLUDED



u03

led integrato

integrated led

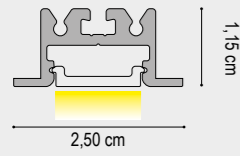

DATI TECNICI
TECHNICAL DATA

	1 cm
Nominal LED Flux:	1590 lm/m
Flux Tot:	1272 lm/m
Output:	110 lm/W
CCT:	3000 K
CRI:	>95
Power Tot:	14.4 W/m
Weight:	0.40 Kg/m

Profilo/Profile: Alluminio/aluminum
Cover: Opale/opal

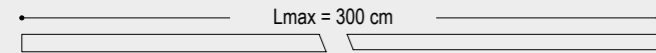

DRIVER NON INCLUSO / NOT INCLUDED

CAVO ALIMENTAZIONE: 50 cm
ALIMENTATION CABLE: 50 cm

1 cm

FINITURA STRUTTURA
FINISHES

- GRIGIO VESUVIO ANTHRACITE
- ARGILLA CLAY
- ARGENTO OPACO/MATT SILVER
- BIANCO INTONACO/WHITE
- NERO CARAVAGGIO BLACK
- MOKA MOCHA
- CROMO CHROME
- ORO CALIFORNIA/GOLD
- ARAMEN COPPER
- ARGENTO COMETA/SILVER COMET
- OTTONE VENEZIANO BRASS
- TITANIO/TITANIUM
- BRONZO RIACI/RIACI BRONZE
- VERDE COSTA/GREEN COAST
- TERRA SENESE SENESE EARTH

DIFFUSORE
DIFFUSER

OPALE/OPAL

CODICE 2700K CODE 2700K
114G100001
114G101001
114G102001
114G103001
114G104001
114G114001
114G108001
114G109001
114G110001
114G112001
114G113001
114G114001
114G115001
114G116001
114G117001

CODICE 3000K CODE 3000K
114G201001
114G201001
114G202001
114G203001
114G204001
114G205001
114G208001
114G209001
114G210001
114G212001
114G213001
114G214001
114G215001
114G215001
114G217001

CODICE 4000K CODE 4000K
114G301001
114G301001
114G302001
114G303001
114G304001
114G305001
114G208001
114G309001
114G310001
114G312001
114G313001
114G314001
114G315001
114G316001
114G317001

N.B./P.N.: LUNGHEZZA MASSIMA VERSIONE CROMO = 2,00 m / MAXIMUM LENGTH CHROME VERSION = 2.00 m
TESTATE DI CHIUSURA NON INCLUSE / DEAD ENDS NOT INCLUDED



u03

led integrato

integrated led

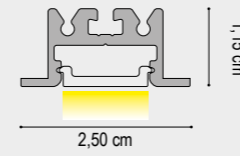

DATI TECNICI
TECHNICAL DATA

	1 cm
Nominal LED Flux:	1610 lm/m
Flux Tot:	1290 lm/m
Output:	135 lm/W
CCT:	3000 K
CRI:	>97 - R9>90
Power Tot:	12 W/m
Weight:	0.40 Kg/m

Profilo/Profile: Alluminio/aluminum
Cover: Opale/opal

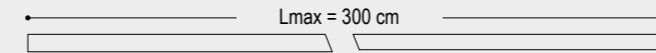

DRIVER NON INCLUSO / NOT INCLUDED

CAVO ALIMENTAZIONE: 50 cm
ALIMENTATION CABLE: 50 cm

1 cm

FINITURA STRUTTURA
FINISHES

- GRIGIO VESUVIO ANTHRACITE
- ARGILLA CLAY
- ARGENTO OPACO/MATT SILVER
- BIANCO INTONACO/WHITE
- NERO CARAVAGGIO BLACK
- MOKA MOCHA
- CROMO CHROME
- ORO CALIFORNIA/GOLD
- ARAMEN COPPER
- ARGENTO COMETA/SILVER COMET
- OTTONE VENEZIANO BRASS
- TITANIO/TITANIUM
- BRONZO RIACI/RIACI BRONZE
- VERDE COSTA/GREEN COAST
- TERRA SENESE SENESE EARTH

DIFFUSORE
DIFFUSER

OPALE/OPAL

CODICE 2700K CODE 2700K
1149600001
1149601001
1149602001
1149603001
1149604001
1149605001
1149608001
1149609001
1149610001
1149612001
1149613001
1149614001
1149615001
1149616001
1149617001

CODICE 3000K CODE 3000K
1149700001
1149701001
1149702001
1149703001
1149704001
1149705001
1149708001
1149709001
1149710001
1149712001
1149713001
1149714001
1149715001
1149716001
1149717001

CODICE 4000K CODE 4000K
1149800001
1149801001
1149802001
1149803001
1149804001
1149805001
1149808001
1149809001
1149810001
1149812001
1149813001
1149814001
1149815001
1149816001
1149817001

N.B./P.N.: LUNGHEZZA MASSIMA VERSIONE CROMO = 2,00 m / MAXIMUM LENGTH CHROME VERSION = 2.00 m
TESTATE DI CHIUSURA NON INCLUSE / DEAD ENDS NOT INCLUDED





LED compatibili / LED compatibility

HIGH QUALITY CRI>90 CRI>95	HIGH OUTPUT CRI>90 CRI>95	HIGH EFFICIENT CRI>90 CRI>95	HIGH INTENSITY CRI>90 CRI>95	LOW POWER CRI>90	ULTRA SLIM CRI>90 CRI>95 CRI>97	RGB	RGB WHITE	RGB TW	TUNABLE WHITE
9,6W 14,4W 19,2W	12,3W 14,4W 19,2W 20W 24W	12,3W 14,4W 19,2W 20W 24W	24W 24W (700 LED)	6W	9,6W 12W 14,4W	14W	14W	14,4W 23W	19,2W

FINITURA STRUTTURA FINISHES	1 cm	200 cm	300 cm
	CODICE CODE	CODICE CODE	CODICE CODE
GRIGIO VESUVIO/ANTHRACITE	1140300001	1140300200	1140300300
ARGILLA/ARGIL	1140301001	1140301200	1140301300
ARGENTO OPACO/MATT SILVER	1140302001	1140302200	1140302300
BIANCO INTONACO/WHITE	1140303001	1140303200	1140303300
NERO CARAVAGGIO/BLACK	1140304001	1140304200	1140304300
MOKA/MOCHA	1140305001	1140305200	1140305300
ALLUMINIO NATURALE/ALUMINUM	1140306001	1140306200	1140306300
ORO CALIFORNIA/GOLD	1140309001	1140309200	1140309300
ARAMEN/COPPER	1140310001	1140310200	1140310300
ARGENTO COMETA/SILVER COMET	1140312001	1140312200	1140312300
OTTONE VENEZIANO/BRASS	1140313001	1140313200	1140313300
TITANIO/TITANIUM	1140314001	1140314200	1140314300
BRONZO RIACI/RIACI BRONZE	1140315001	1140315200	1140315300
VERDE COSTA/GREEN COAST	1140316001	1140316200	1140316300
TERRA SENESE/SENESE EARTH	1140317001	1140317200	1140317300
CROMO/CHROME	1140308001	1140308200	

ATTENZIONE/PLEASE NOTE: LUNGHEZZA MASSIMA VERSIONE CROMO = 2,00 m / MAXIMUM LENGTH CHROME VERSION = 2.00 m
TESTATE DI CHIUSURA NON INCLUSE / DEAD ENDS NOT INCLUDED

DIFFUSORE

DIFFUSORE DIFFUSER	1 cm	200 cm	300 cm
	CODICE CODE	CODICE CODE	CODICE CODE
OPALE/OPAL	1140100001	1140100200	1140100300
SATINATA/SATIN	1140101001	1140101200	1140101300



TESTATE DI CHIUSURA / DEAD ENDS

FINITURA STRUTTURA FINISHES	CODICE CODE	FINITURA STRUTTURA FINISHES	CODICE CODE
GRIGIO VESUVIO/ANTHRACITE	1140400000	ARAMEN/COPPER	1140410000
ARGILLA/ARGIL	1140401000	GRIGIO AVIO/GREY AVIO	1140411000
ARGENTO OPACO/MATT SILVER	1140402000	ARGENTO COMETA/SILVER COMET	1140412000
BIANCO INTONACO/WHITE	1140403000	OTTONE VENEZIANO/BRASS	1140413000
NERO CARAVAGGIO/BLACK	1140404000	TITANIO/TITANIUM	1140414000
MOKA/MOCHA	1140405000	BRONZO RIACI/RIACI BRONZE	1140415000
ALLUMINIO NATURALE/ALUMINUM	1140406000	VERDE COSTA/GREEN COAST	1140416000
CROMO/CHROME	1140408000	TERRA SENESE/SENESE EARTH	1140417000
ORO CALIFORNIA/GOLD	1140409000		

Nel codice sono comprese le viti per il fissaggio delle testate al profilo. Il codice contiene n° 1 testate di chiusura. / The code includes the screws for fixing the heads to the profile. The code contains 1 closing warheads

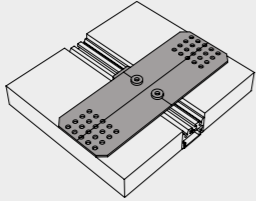

STAFFA INCASSO PER CARTONGESSO / SEMI-BASED BRACKET FOR PLASTERBOARD

DATI TECNICI TECHNICAL DATA	FINITURA STRUTTURA FINISHES	CODICE CODE
<p>ARTICOLI INCLUSI NEL CODICE ARTICLES INCLUDED IN THE CODE</p> <p>Clip di fissaggio in policarbonato 3mm Fixing clip in 3mm polycarbonate Viti per il fissaggio del profilo alla staffa Screws for fixing the profile to the bracket</p> 	ALLUMINIO NATURALE/ALUMINUM	1090500001
<p>MOLLA PER INCASSO IN CARTONGESSO N°01 PZ SPRING FOR PLASTERBOARD INSTALLATION N°01 PZ</p> 	ALLUMINIO NATURALE/ALUMINUM	1140501

GIUNTI / JOINTS

DATI TECNICI TECHNICAL DATA	FINITURA STRUTTURA FINISHES	CODICE CODE
<p>GIUNTO LINEA CONTINUA / STRAIGHT JOINT</p> <p>Accessorio per giunzioni meccaniche lineari Accessory for linear mechanical joints</p> 	ALLUMINIO NATURALE/ALUMINUM	1010500006
<p>GIUNTO 90° ORIZZONTALE / HORIZONTAL JOINT 90°</p> <p>Accessorio per giunzioni meccaniche con angolo 90° Accessory for linear mechanical joints with 90° angle</p> 	ALLUMINIO NATURALE/ALUMINUM	1010500005
<p>GIUNTO 90° VERTICALE / VERTICAL JOINT 90°</p> <p>Accessorio per giunzioni meccaniche con angolo 90° Accessory for linear mechanical joints with 90° angle</p> 	ALLUMINIO NATURALE/ALUMINUM	1010500007

Nel codice sono compresi i grani per il fissaggio del giunto / The code includes the grains for fixing the joint.

INTERRUTTORE DIMMERABILE+INSTALLAZIONE / DIMMABLE SWITCH+INSTALLATION

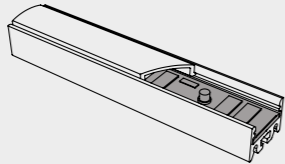
DATI TECNICI TECHNICAL DATA	FINITURA STRUTTURA FINISHES	CODICE CODE
<p>Accessorio che consente l'accensione e lo spegnimento dei LED e, a seconda della pressione, la regolazione dell'intensità luminosa. Accessory that allows the switching on and off of the LEDs and, depending on the pressure, the regulation of the light intensity.</p> <p>Tensione di alimentazione: 12-24V DC Supply voltage: 12-24V DC Corrente d'uscita: 4A max Output current: 4A max ON / OFF: contact < 0.7 s DIMMER: contact > 0.7 s</p> 	ALLUMINIO NATURALE/ALUMINUM	98244

STAFFA DI FISSAGGIO / MOUNTING CLIP

FINITURA FINISHES	CODICE CODE
SUPERFICI PIANE 2mm EVEN SURFACE 2mm	1020500003
SUPERFICI IRREGOLARI 3,5mm UNEVEN SURFACE 3,5mm	1020500004









Accessorio per fissaggio a plafone/superficie. Quantità raccomandata: 1 pz ogni 50 cm di profilo
Ceiling/surface mounting accessory. Recommended quantity: 1 pc every 50 cm of profile

CALAMITA / MAGNET

CODICE CODE	PORTATA RANGE
102050001	1 Kg
1020500210	2 Kg

Quantità raccomandata: 1 pz ogni 25cm di profilo
Recommended quantity: 1 pc every 25cm of profile

LAVORAZIONI / PROCESSING

DATI TECNICI TECHNICAL DATA	CODICE CODE
<p>TAGLIO 90° ORIZZONTALE (PER ANGOLI FORMATI DA DUE PROFILI) HORIZONTAL 90 ° CUT (FOR CORNERS MADE OF TWO PROFILES)</p> 	190X
<p>TAGLIO 90° VERTICALE (PER ANGOLI FORMATI DA DUE PROFILI) VERTICAL 90 ° CUT (FOR CORNERS MADE OF TWO PROFILES)</p> 	190Y
<p>TAGLIO ANGOLARE CUSTOM (PER ANGOLI FORMATI DA DUE PROFILI) CUSTOM CORNER CUT (FOR CORNERS MADE OF TWO PROFILES)</p> 	190N
<p>FORO / HOLE</p> 	100F
<p>ASOLA / SLOT</p> 	100A
<p>ASOLA CUSTOM / SLOT CUSTOM</p> 	100N
<p>CABLAGGIO - COLLAUDO - CE AL CENTIMETRO INSTALLATION AND TESTING LED MODULE AT CENTIMETER</p> 	1141
<p>CAVO DI ALIMENTAZIONE 2X0,50 BIANCO 1CM POWER CABLE 2X0,50 WHITE 1CM</p> 	98CB001
<p>CAVO DI ALIMENTAZIONE 2X0,50 NERO 1CM POWER CABLE 2X0,50 BLACK 1CM</p>	98CN001

“preziose finiture”

Una sospensione minimale con un tocco di personalità inconfondibile. MIRA ha un diffusore che si allarga dal sostegno metallico per consentire una maggiore diffusione della luce. Ne risulta una luminosità “morbida” con una presenza leggermente sofisticata. Negli ambienti di lavoro o commerciali può essere utilizzata con successo. Grazie alle preziose finiture, come il cavo in stoffa, tiranti in acciaio e rosone, diventa un arredo di pregio negli ambienti domestici. Temperatura di colore calda K3000.

A minimal suspended a lamp with an unmistakable touch of personality: MIRA has a diffuser extending out of the metallic truck to obtain a large light expansion. The result is a soft light sophisticated presence. It could be a real success in working spaces or commercial areas. Thanks to precious trimmings: fabric cable, steel tie-rod, cable holder, Mirage becomes a luxury furniture object for domestic use. Warm light colour K3000.



mira

configurazioni

configurations

mira

led integrato

integrated led

INSTALLAZIONE A SOSPENSIONE
SUSPENSION

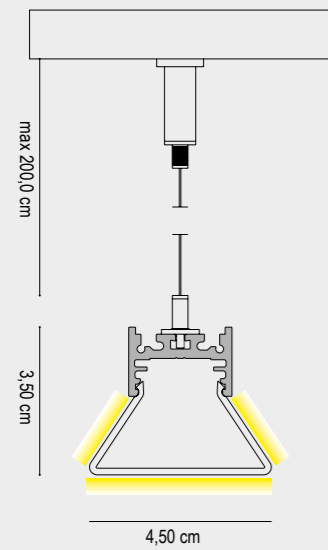

INSTALLAZIONE CON CLIP IN POLICARBONATO SU
SUPERFICIE ORIZZONTALE
INSTALLATION WITH POLYCARBONATE CLIP ON HORIZONTAL SURFACE

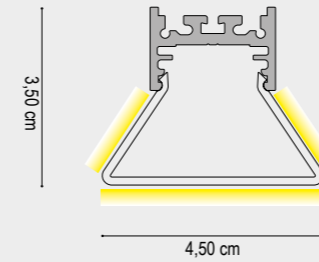
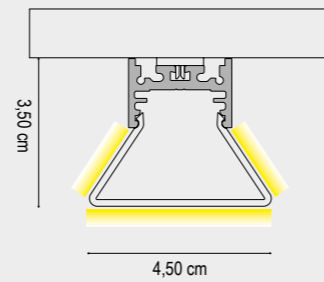

DATI TECNICI
TECHNICAL DATA

	1 cm
LED Flux Tot:	2200 lm/m
Flux Tot:	1760 lm/m
Output:	105 lm/W
CCT:	3000 K
CRI:	>90
Power Tot:	20.0 W/m
Weight:	0.80 Kg/m

Profilo/Profile: Alluminio/aluminum
Cover: Opale/opal

DRIVER NON INCLUSO / NOT INCLUDED

CAVO ALIMENTAZIONE: 50 cm
ALIMENTATION CABLE: 50 cm

INSTALLAZIONE CON STAFFA MAGNETICA SU SUPERFICIE METALLICA ORIZZONTALE
INSTALLATION WITH MAGNET ON HORIZONTAL METAL SURFACE

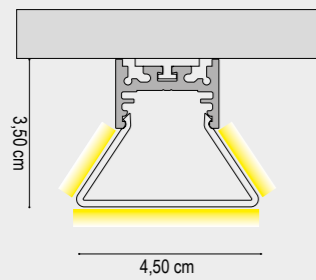

INSTALLAZIONE A PARETE CON STAFFA ORIENTABILE
WALL INSTALLATION WITH ADJUSTABLE BRACKET

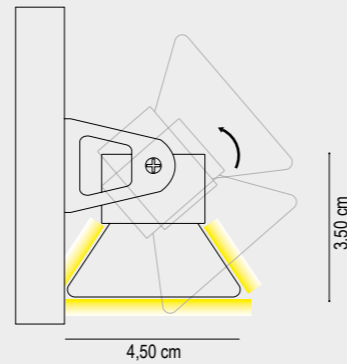

SI RACCOMANDA L'UTILIZZO DI N° 1 STAFFA MAGNETICA OGNI 25,00 cm DI PROFILO. TALE QUANTITÀ PUÒ VARIARE A SECONDA DELLA SUPERFICIE METALLICA DI INSTALLAZIONE.

WE RECOMMEND THE USE OF N° 1 MAGNETIC BRACKET EVERY 25.00 cm OF PROFILE. THIS QUANTITY MAY VARY DEPENDING ON THE METAL INSTALLATION SURFACE.

FINITURA STRUTTURA
FINISHES

- GRIGIO VESUVIO ANTHRACITE
- ARGILLA CLAY
- ARGENTO OPACO/MATT SILVER
- BIANCO INTONACO/WHITE
- NERO CARAVAGGIO BLACK
- MOKA MOCHA
- CROMO/CHROME
- ORO CALIFORNIA/GOLD
- ARAMEN COPPER
- ARGENTO COMETA/SILVER COMET
- OTTONE VENEZIANO BRASS
- TITANIO/TITANIUM
- BRONZO RIACI/RIACI BRONZE
- VERDE COSTA/GREEN COAST
- TERRA SENESE SENESE EARTH

DIFFUSORE
DIFFUSER

OPALE/OPAL

CODICE 2700K
CODE 2700K

- 1034600501
- 1034601501
- 1034602501
- 1034603501
- 1034604501
- 1034605501
- 1034608501
- 1034609501
- 1034610501
- 1034612501
- 1034613501
- 1034614501
- 1034615501
- 1034616501
- 1034617501

CODICE 3000K
CODE 3000K

- 1034700501
- 1034701501
- 1034702501
- 1034703501
- 1034704501
- 1034705501
- 1034708501
- 1034709501
- 1034710501
- 1034712501
- 1034713501
- 1034714501
- 1034715501
- 1034715501
- 1034717501

CODICE 4000K
CODE 4000K

- 1034800501
- 1034801501
- 1034802501
- 1034803501
- 1034804501
- 1034805501
- 1034808501
- 1034809501
- 1034810501
- 1034812501
- 1034813501
- 1034814501
- 1034815501
- 1034816501
- 1034817501

N.B./P.N.: LUNGHEZZA MASSIMA VERSIONE CROMO = 2,00 m / MAXIMUM LENGTH CHROME VERSION = 2.00 m
TESTATE DI CHIUSURA NON INCLUSE / DEAD ENDS NOT INCLUDED

STAFFA DI FISSAGGIO / MOUNTING CLIP

FINITURA FINISHES	CODICE CODE
SUPERFICI PIANE 2mm EVEN SURFACE 2mm	1020500003
SUPERFICI IRREGOLARI 3,5mm UNEVEN SURFACE 3,5mm	1020500004

Accessorio per fissaggio a plafone/superficie. Quantità raccomandata: 1 pz ogni 50 cm di profilo Ceiling/surface mounting accessory. Recommended quantity: 1 pc every 50 cm of profile

CALAMITA / MAGNET

CODICE CODE	PORTATA RANGE
102050001	1 Kg
1020500210	2 Kg

Quantità raccomandata: 1 pz ogni 25cm di profilo Recommended quantity: 1 pc every 25cm of profile



TESTATE DI CHIUSURA / DEAD ENDS

FINITURA STRUTTURA FINISHES	CODICE CODE	PREZZO PRICE	FINITURA STRUTTURA FINISHES	CODICE CODE
GRIGIO VESUVIO/ANTHRACITE	1030400100	€ 7,10	ARAMEN/COPPER	1030410100
ARGILLA/ARGIL	1030401100	€ 7,10	GRIGIO AVIO/GREY AVIO	1030411100
ARGENTO OPACO/MATT SILVER	1030402100	€ 6,90	ARGENTO COMETA/SILVER COMET	1030412100
BIANCO INTONACO/WHITE	1030403100	€ 7,10	OTTONE VENEZIANO/BRASS	1030413100
NERO CARAVAGGIO/BLACK	1030404100	€ 7,10	TITANIO/TITANIUM	1030414100
MOKA/MOCHA	1030405100	€ 7,10	BRONZO RIACI/RIACI BRONZE	1030415100
CROMO/CHROME	1030408100	€ 7,80	VERDE COSTA/GREEN COAST	1030416100
ORO CALIFORNIA/GOLD	1030409100	€ 7,30	TERRA SENESE/SENESE EARTH	1030417100

Nel codice sono comprese le viti per il fissaggio delle testate al profilo. Il codice contiene n° 1 testate di chiusura. / The code includes the screws for fixing the heads to the profile. The code contains 1 closing warheads

KIT DI SOSPENSIONE / SUSPENSION KIT

DATI TECNICI TECHNICAL DATA	FINITURA STRUTTURA FINISHES	CODICE CODE
ARTICOLI INCLUSI NEL CODICE ARTICLES INCLUDED IN THE CODE Cavo in acciaio 2,00m con puntalino 2.00m steel cable with tip Boccola cromata con regolazione millimetrica Chrome bush with millimeter adjustment Archetto in alluminio per sospensione Aluminum arch for suspension	GRIGIO VESUVIO/ANTHRACITE	1040500004
	ARGILLA/ARGIL	1040501004
	ARGENTO OPACO/MATT SILVER	1040502004
	BIANCO INTONACO/WHITE	1040503004
	NERO CARAVAGGIO/BLACK	1040504004
	MOKA/MOCHA	1040505004
	CROMO/CHROME	1040508004
	ORO CALIFORNIA/GOLD	1040509004
	ARAMEN/COPPER	1040510004
	ARGENTO COMETA/SILVER COMET	1030712004
	OTTONE VENEZIANO/BRASS	1030713004
	TITANIO/TITANIUM	1090714004
	BRONZO RIACI/RIACI BRONZE	1090715004
VERDE COSTA/GREEN COAST	1090716004	
TERRA SENESE/SENESE EARTH	1040517004	

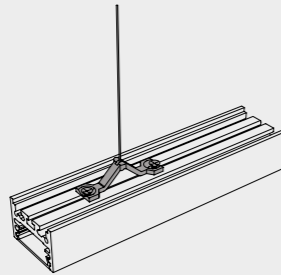

STAFFA A PARETE REGOLABILE / ADJUSTABLE WALL BRACKET

DATI TECNICI TECHNICAL DATA	FINITURA STRUTTURA FINISHES	CODICE CODE
MATERIALE: Alluminio naturale MATERIAL: Natural aluminum ARTICOLI INCLUSI NEL CODICE ARTICLES INCLUDED IN THE CODE N°1 staffa regolabile in alluminio N° 1 adjustable aluminum bracket Viti per il fissaggio Screws for fixing	GRIGIO VESUVIO/ANTHRACITE	1030500005
	ARGILLA/ARGIL	1030501005
	ARGENTO OPACO/MATT SILVER	1030502005
	BIANCO INTONACO/WHITE	1030503005
	NERO CARAVAGGIO/BLACK	1030504005
	MOKA/MOCHA	1030505005
	CROMO/CHROME	1030508005
	ORO CALIFORNIA/GOLD	1030509005
	ARAMEN/COPPER	1030510005
	GRIGIO AVIO/GREY AVIO	1030511005
	ARGENTO COMETA/SILVER COMET	1030512005
	OTTONE VENEZIANO/BRASS	1030513005
	TITANIO/TITANIUM	1030514005
	BRONZO RIACI/RIACI BRONZE	1030515005
	VERDE COSTA/GREEN COAST	1030516005
TERRA SENESE/SENESE EARTH	1030517005	

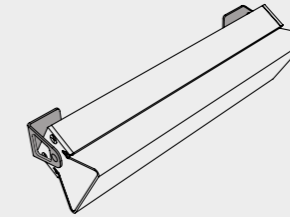

GIUNTI / JOINTS

DATI TECNICI TECHNICAL DATA	FINITURA FINISHES	CODICE CODE
GIUNTO LINEA CONTINUA / STRAIGHT JOINT Accessorio per giunzioni meccaniche lineari Accessory for linear mechanical joints	ALLUMINIO NATURALE/ALUMINUM	1010500006
GIUNTO 90° ORIZZONTALE / HORIZONTAL JOINT 90° Accessorio per giunzioni meccaniche con angolo 90° Accessory for linear mechanical joints with 90° angle	ALLUMINIO NATURALE/ALUMINUM	1030500006

Nel codice sono compresi i grani per il fissaggio del giunto / The code includes the grains for fixing the joint.

“massima espressione tecnologica della microestrusione dell'alluminio”

MC01, l'entry level dei nostri profili in alluminio. Compatto e flessibile. MC01 è la massima espressione tecnologica della microestrusione dell'alluminio, finalizzata alla dissipazione termica. Abbinato alla cover in policarbonato assicura una luce morbida e diffusa.

MC01, our aluminum profile entry level. Compact and for all around applications. MC01 expresses the best technology for micro-extruded aluminum profiles finalized for heat dissipation. With the selection of polycarbonate covers it ensures a smooth and diffused light.





VERSIONE KIT / KIT VERSION

ARTICOLI INCLUSI NEL CODICE
ARTICLES INCLUDED IN THE CODE
Profilo: Alluminio / Profile: Aluminum
Cover: Satinato / Cover: Satin

PER LUNGHEZZA 2,00m
N°2 testate di chiusura / No. 2 closing heads
N°2 staffe di fissaggio / No. 2 fixing brackets

PER LUNGHEZZA 3,00m
N°2 testate di chiusura / No. 2 closing heads
N°3 staffe di fissaggio / No. 3 fixing brackets

FINITURA STRUTTURA
FINISHES

ARGENTO OPACO/MATT SILVER
BIANCO INTONACO/WHITE
NERO CARAVAGGIO BLACK

DIFFUSORE
DIFFUSER

SATINATA/SATIN

200 cm

CODICE
CODE

1280111202
1280111203
1280111204

300 cm

CODICE
CODE

1280111302
1280111303
1280111304

TESTATE DI CHIUSURA / DEAD ENDS

FINITURA FINISHES	CODICE CODE	PREZZO PRICE	FINITURA FINISHES	CODICE CODE
 BIANCO/WHITE	1280000002	€ 1,50	 BIANCO/WHITE	1280000001

Il codice contiene n° 1 testate di chiusura.
The code contains 1 closing warheads

STAFFA DI FISSAGGIO A A PARETE / WALL MOUNTING CLIP

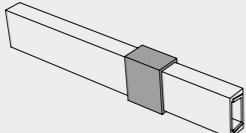
DATI TECNICI TECHNICAL DATA	FINITURA STRUTTURA FINISHES	CODICE CODE
MATERIALE: Alluminio naturale MATERIAL: Natural aluminum 	ALLUMINIO NATURALE/ALUMINUM	1280000003

STAFFA DI FISSAGGIO A A PARETE REGOLABILE / ADJUSTABLE WALL MOUNTING CLIP

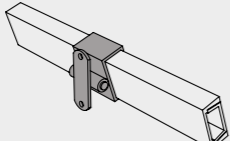
DATI TECNICI TECHNICAL DATA	FINITURA STRUTTURA FINISHES	CODICE CODE
MATERIALE: Alluminio naturale MATERIAL: Natural aluminum 	ALLUMINIO NATURALE/ALUMINUM	1280000004



VERSIONE KIT / KIT VERSION

ARTICOLI INCLUSI NEL CODICE
ARTICLES INCLUDED IN THE CODE
Profilo: Alluminio / Profile: Aluminum
Cover: Satinato / Cover: Satin

PER LUNGHEZZA 2,00m
N°2 testate di chiusura / No. 2 closing heads
N°2 staffe di fissaggio / No. 2 fixing brackets

FINITURA STRUTTURA
FINISHES

ARGENTO OPACO/MATT SILVER

DIFFUSORE
DIFFUSER

SATINATA/SATIN

200 cm

CODICE
CODE

1270111202

TESTATE DI CHIUSURA / DEAD ENDS

FINITURA FINISHES	CODICE CODE	PREZZO PRICE	FINITURA FINISHES	CODICE CODE
 GRIGIO/GREY	1270000002	€ 1,50	 GRIGIO/GREY	1270000001

Il codice contiene n° 1 testate di chiusura.
The code contains 1 closing warheads

STAFFA DI FISSAGGIO / MOUNTING CLIP

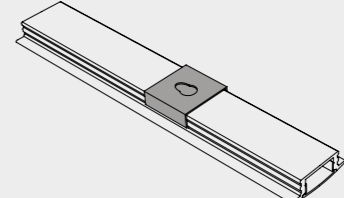
DATI TECNICI TECHNICAL DATA	FINITURA STRUTTURA FINISHES	CODICE CODE
MATERIALE: Alluminio naturale MATERIAL: Natural aluminum 	ALLUMINIO NATURALE/ALUMINUM	1270000003

mf01 + mf02

**“massima espressione tecnologica
della microestruzione flessibile
dell’alluminio”**

MF01 è il più piccolo prodotto flessibile della nostra nuova gamma di profili in alluminio. È la massima espressione tecnologica della microestruzione flessibile dell’alluminio, finalizzata alla dissipazione termica. Le sue ridotte dimensioni e la possibilità di essere curvato lo rendono unico e sicuramente molto apprezzato e usato dai progettisti.

MF01 is the smallest flexible product in our new range of aluminum profiles. It's the maximum of aluminum microextrusion's technological expression, aimed to dissipate heat in the right mode. The small size and the ability to be curved, makes it unique and it will be certainly appreciated very much by designers.

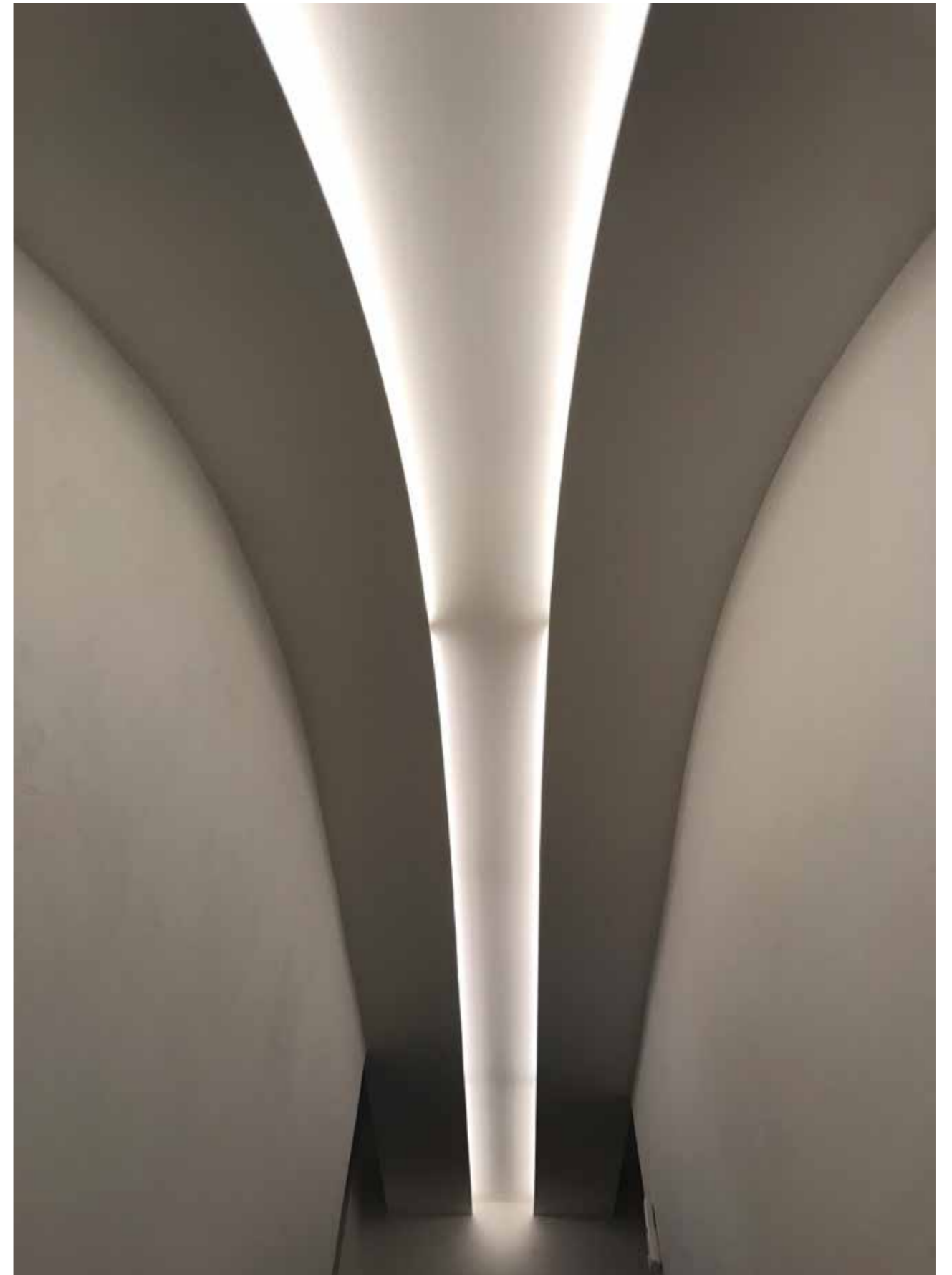

mf01

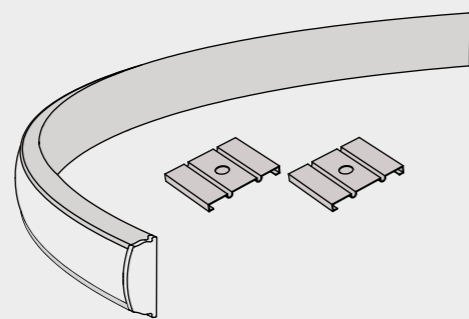
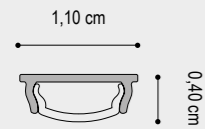

mf02

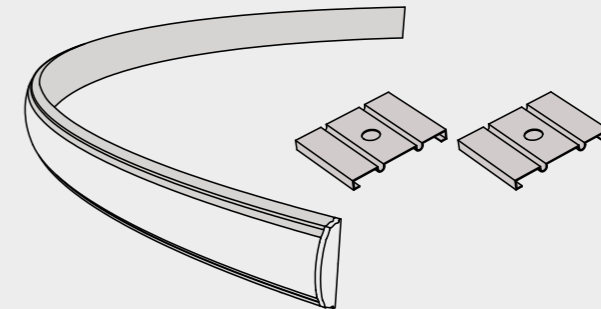
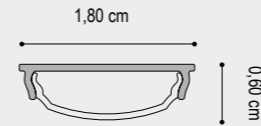

scheda tecnica



VERSIONE KIT / KIT VERSION

		200 cm	
ARTICOLI INCLUSI NEL CODICE ARTICLES INCLUDED IN THE CODE Profilo / Profile Diffusore / Diffuser	FINITURA STRUTTURA FINISHES	DIFFUSORE DIFFUSER	CODICE CODE
<p>PER LUNGHEZZA 2,00m N°2 testate di chiusura / No. 2 closing heads N°2 staffe di fissaggio / No. 2 fixing brackets</p> <p>PER LUNGHEZZA 3,00m N°2 testate di chiusura / No. 2 closing heads N°3 staffe di fissaggio / No. 3 fixing brackets</p>	<p>ARGENTO OPACO/MATT SILVER</p> <p>BIANCO INTONACO/WHITE</p> <p>NERO CARAVAGGIO/BLACK</p>	<p>SATINATA/SATIN</p>	<p>1280102200</p> <p>1280103200</p> <p>1280104200</p>

VERSIONE KIT / KIT VERSION



		200 cm	
ARTICOLI INCLUSI NEL CODICE ARTICLES INCLUDED IN THE CODE Profilo / Profile Diffusore / Diffuser	FINITURA STRUTTURA FINISHES	DIFFUSORE DIFFUSER	CODICE CODE
<p>PER LUNGHEZZA 2,00m N°2 testate di chiusura / No. 2 closing heads N°2 staffe di fissaggio / No. 2 fixing brackets</p> <p>PER LUNGHEZZA 3,00m N°2 testate di chiusura / No. 2 closing heads N°3 staffe di fissaggio / No. 3 fixing brackets</p>	<p>ARGENTO OPACO/MATT SILVER</p> <p>BIANCO INTONACO/WHITE</p> <p>NERO CARAVAGGIO/BLACK</p>	<p>SATINATA/SATIN</p>	<p>1281102200</p> <p>1281103200</p> <p>1281104200</p>

TESTATE DI CHIUSURA / DEAD ENDS

FINITURA FINISHES	CODICE CODE	PREZZO PRICE	FINITURA FINISHES	CODICE CODE
 BIANCO/WHITE	1280100001	€ 1,50	 BIANCO/WHITE	1280100002

Il codice contiene n° 1 testate di chiusura.
The code contains 1 closing warheads

TESTATE DI CHIUSURA / DEAD ENDS

FINITURA FINISHES	CODICE CODE	PREZZO PRICE	FINITURA FINISHES	CODICE CODE
 BIANCO/WHITE	1281100002	€ 1,50	 BIANCO/WHITE	1281100002

Il codice contiene n° 1 testate di chiusura.
The code contains 1 closing warheads

STAFFA DI FISSAGGIO A A PARETE / WALL MOUNTING CLIP

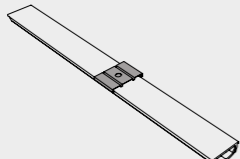
DATI TECNICI TECHNICAL DATA	FINITURA STRUTTURA FINISHES	CODICE CODE
<p>MATERIALE: Alluminio naturale MATERIAL: Natural aluminum</p> 	<p>ALLUMINIO NATURALE/ALUMINUM</p>	<p>1280100003</p>

STAFFA DI FISSAGGIO A A PARETE / WALL MOUNTING CLIP

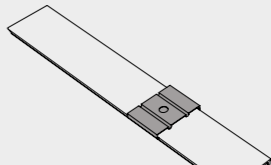
DATI TECNICI TECHNICAL DATA	FINITURA STRUTTURA FINISHES	CODICE CODE
<p>MATERIALE: Alluminio naturale MATERIAL: Natural aluminum</p> 	<p>ALLUMINIO NATURALE/ALUMINUM</p>	<p>1281100003</p>



“illuminazione scenica e d’effetto”

QUADRA, la luce fa quadrato. Forma a sezione quadrata, semplice e pulita, con molte possibilità di personalizzazione sia nei colori che nelle sorgenti luminose. Può alloggiare lampade LED con attacco GU10 e consente un fissaggio rapido grazie al suo sistema di aggancio a scatto. Progettato per integrarsi sia in ambienti classici che moderni, QUADRA garantisce un’illuminazione scenica e d’effetto.

QUADRA, the light is square. Square section shape, simple and clean, with many customization possibilities both in colors and light sources. It can house LED lamps with GU10 socket and allows quick fixing thanks to its snap-on coupling system. Designed to integrate in both classic and modern environments, QUADRA guarantees scenic and effective lighting.

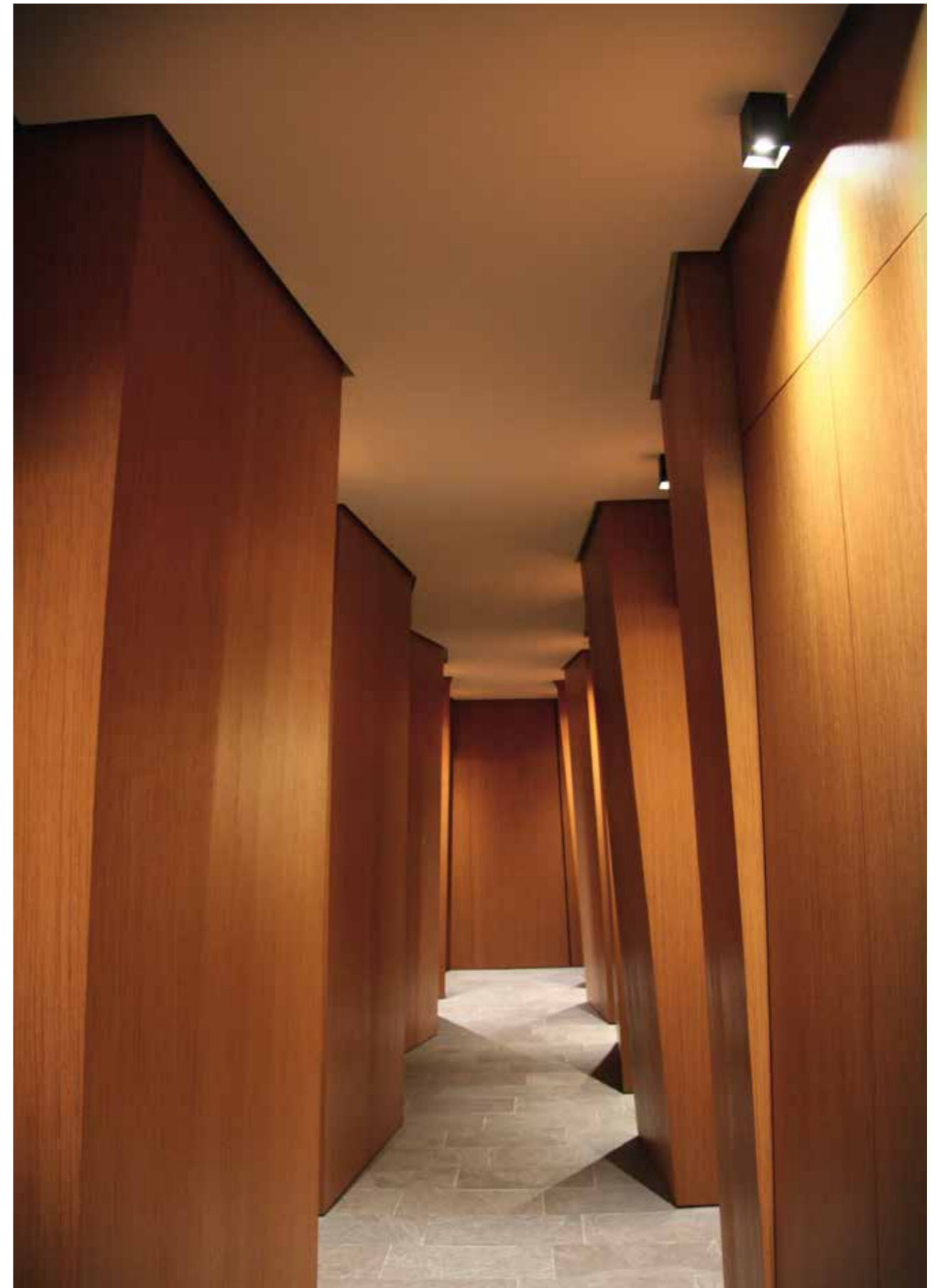



QUADRA 70

DIMENSIONI DIMENSIONS	ATTACCO SOCKET	TENSIONE - V VOLTAGE - V	FINITURA STRUTTURA FINISHES	CODICE CODE
	GU10	220 V	<ul style="list-style-type: none"> BIANCO INTONACO/WHITE NERO CARAVAGGIO/BLACK MOKA/MOCHA ORO CALIFORNIA/GOLD TERRA SENESE/SENESE EARTH 	<ul style="list-style-type: none"> 1007110010 1007110020 1007110040 1007110090 1007110170

QUADRA 80

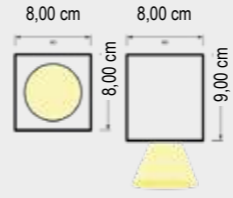
DIMENSIONI DIMENSIONS	ATTACCO SOCKET	TENSIONE - V VOLTAGE - V	FINITURA STRUTTURA FINISHES	CODICE CODE
	GU10	220 V	<ul style="list-style-type: none"> BIANCO INTONACO/WHITE NERO CARAVAGGIO/BLACK MOKA/MOCHA ORO CALIFORNIA/GOLD TERRA SENESE/SENESE EARTH 	<ul style="list-style-type: none"> 1008910010 1008910020 1008910040 1008910090 1008910170

QUADRA 80L

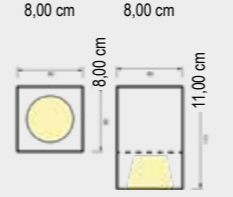
DIMENSIONI DIMENSIONS	ATTACCO SOCKET	TENSIONE - V VOLTAGE - V	FINITURA STRUTTURA FINISHES	CODICE CODE
	GU10	220 V	<ul style="list-style-type: none"> BIANCO INTONACO/WHITE NERO CARAVAGGIO/BLACK MOKA/MOCHA ORO CALIFORNIA/GOLD TERRA SENESE/SENESE EARTH 	<ul style="list-style-type: none"> 1008110010 1008110020 1008110040 1008110090 1008110170

CORPO IN ALLUMINIO ESTRUSO VERNICIATO A POLVERI EPOSSIDICHE. FISSAGGIO RAPIDO. IL PRODOTTO QUADRA VIENE FORNITO SPROVVISTO DI LAMPADA.

EXTRUDED ALUMINUM BODY PAINTED WITH EPOXY POWDERS. QUICK FASTENING. QUADRA PRODUCT IS SUPPLIED WITHOUT LAMP.



faretti

hydria quadro
hydria tondo
flama quadro
flama tondo

hydria + flama

designer

luigi cerbone

“incasso per cartongesso”

HYDRIA e FLAMA, da incasso per cartongesso in alluminio verniciato di forma tonda o quadrata equipaggiati con portalampe GU10 a tensione di rete o a 12V.

HYDRIA and FLAMA, recessed for plasterboard in painted aluminum, round or square, equipped with GU10 lamp holders at mains voltage or 12V.

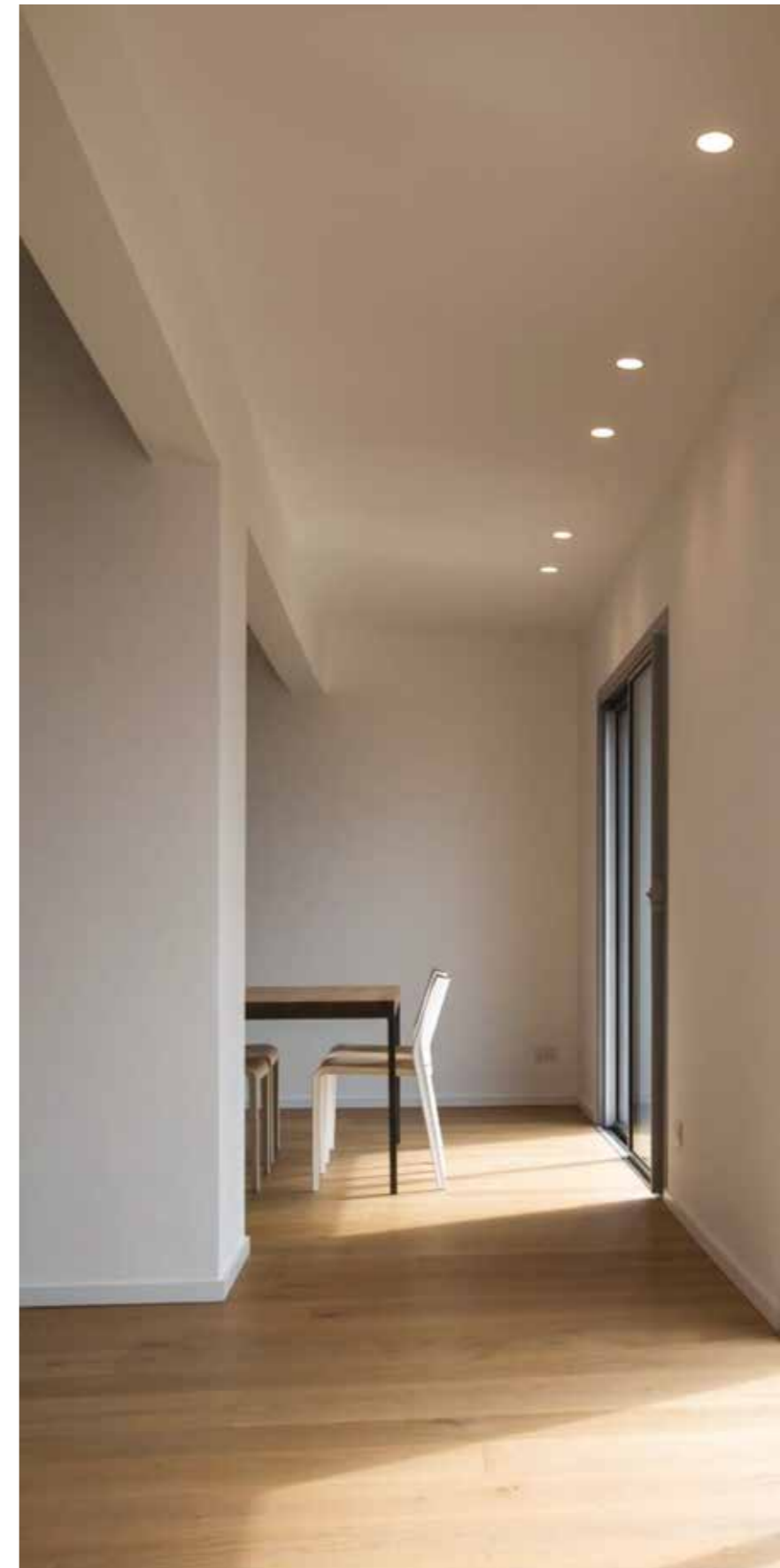

HYDRIA QUADRO

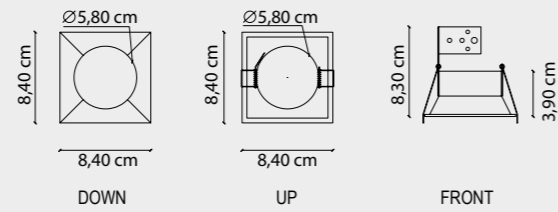

IL PRODOTTO VIENE FORNITO SPROVVISTO DI LAMPADA.
 THE PRODUCT IS SUPPLIED WITHOUT LAMP.

DIMENSIONE FORO HOLE DIMENSIONS	ALTEZZA (mm) HEIGHT (mm)	CARATTERISTICHE FEATURES	FINITURA FINISHES	ATTACCO ATTACK	CODICE CODE
 76 mm x 76 mm	90	12V MAX 50W	BIANCO/WHITE	GU 5,3	1080121211
			NERO/BLACK		1080121222
	110	220V MAX 50W	BIANCO/WHITE	GU 10	1080121112
			NERO/BLACK		1080121121

HYDRIA TONDO

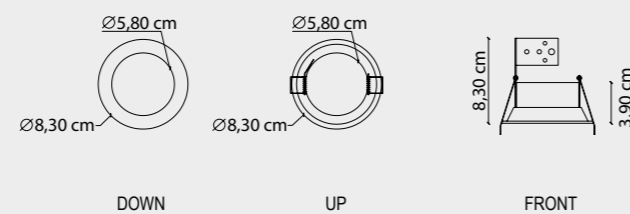

IL PRODOTTO VIENE FORNITO SPROVVISTO DI LAMPADA.
 THE PRODUCT IS SUPPLIED WITHOUT LAMP.

DIMENSIONE FORO HOLE DIMENSIONS	ALTEZZA (mm) HEIGHT (mm)	CARATTERISTICHE FEATURES	FINITURA FINISHES	ATTACCO ATTACK	CODICE CODE
 Ø 75 mm	90	12V MAX 50W	BIANCO/WHITE	GU 5,3	1080122211
			NERO/BLACK		1080122222
	110	220V MAX 50W	BIANCO/WHITE	GU 10	1080122112
			NERO/BLACK		1080122121



FLAMA QUADRO

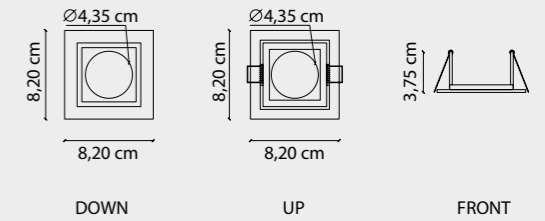

IL PRODOTTO VIENE FORNITO SPROVVISTO DI LAMPADA.
 THE PRODUCT IS SUPPLIED WITHOUT LAMP.

DIMENSIONE FORO HOLE DIMENSIONS	ALTEZZA (mm) HEIGHT (mm)	CARATTERISTICHE FEATURES	FINITURA FINISHES	ATTACCO ATTACK	CODICE CODE
 65 mm x 65 mm	60	12V MAX 50W	BIANCO/WHITE	GU 5,3	1090121211
			NERO/BLACK		1090121222
	90	220V MAX 50W	BIANCO/WHITE	GU 10	1090121112
			NERO/BLACK		1090121121

FLAMA TONDO

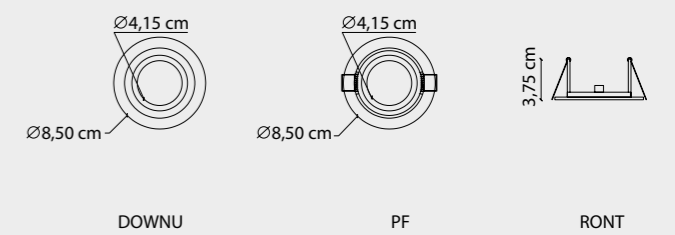

IL PRODOTTO VIENE FORNITO SPROVVISTO DI LAMPADA.
 THE PRODUCT IS SUPPLIED WITHOUT LAMP.

DIMENSIONE FORO HOLE DIMENSIONS	ALTEZZA (mm) HEIGHT (mm)	CARATTERISTICHE FEATURES	FINITURA FINISHES	ATTACCO ATTACK	CODICE CODE
 Ø 70 mm	60	12V MAX 50W	BIANCO/WHITE	GU 5,3	1090122211
			NERO/BLACK		1090122222
	90	220V MAX 50W	BIANCO/WHITE	GU 10	1090122112
			NERO/BLACK		1090122121

BOX DI ALIMENTAZIONE / POWER SUPPLY BOX

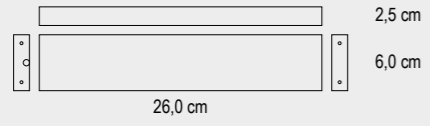
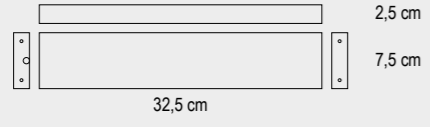
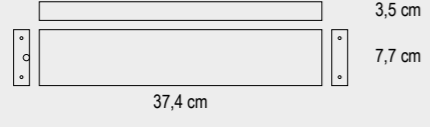
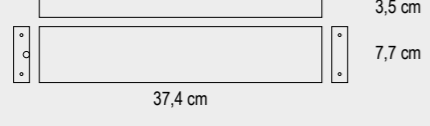
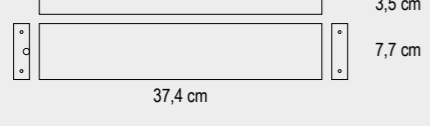
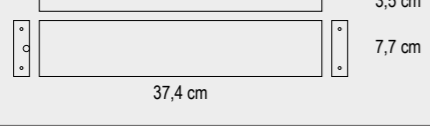
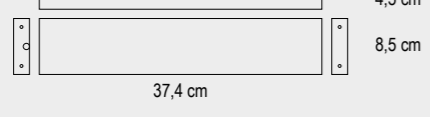
DATI TECNICI TECHNICAL DATA	DIMENSIONI (ln x lg x h) DIMENSIONS	FINITURA FINISHES	POTENZA POWER	CODICE CODE
Tensione/Voltage: 24V - CC SELV / 220-240v - 50-60 Hz Power Factor > 0.9 at > 50% load DC Operation 176-264v DC Ambient Temperature: -15°C to 60°C	 26,0 cm 6,0 cm 2,5 cm	BIANCO/WHITE NERO/BLACK	60 W ON/OFF	10403060 10404060
	 32,5 cm 7,5 cm 2,5 cm	BIANCO/WHITE NERO/BLACK	96 W ON/OFF	10403096 10404096
	 37,4 cm 7,7 cm 3,5 cm	BIANCO/WHITE NERO/BLACK	100 W DIMM	10403100 10404100
	 37,4 cm 7,7 cm 3,5 cm	BIANCO/WHITE NERO/BLACK	120 W ON/OFF	10403120 10404120
	 37,4 cm 7,7 cm 3,5 cm	BIANCO/WHITE NERO/BLACK	60 W DIMM	10403260 10404260
	 37,4 cm 7,7 cm 3,5 cm	BIANCO/WHITE NERO/BLACK	150 W DIMM	10403150 10404150
	 37,4 cm 8,5 cm 4,5 cm	BIANCO/WHITE NERO/BLACK	180 W	10403180 10404180

BOX COPRIMORSETTI / TERMINAL BOX

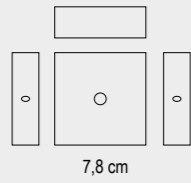
DATI TECNICI TECHNICAL DATA	DIMENSIONI (ln x lg x h) DIMENSIONS	FINITURA FINISHES	CODICE CODE
Tensione/Voltage: 24V - CC SELV / 220-240v - 50-60 Hz Power Factor > 0.9 at > 50% load DC Operation 176-264v DC Ambient Temperature: -15°C to 60°C	 7,8 cm 7,8 cm 2,3 cm	BIANCO/WHITE NERO/BLACK	10403 10404

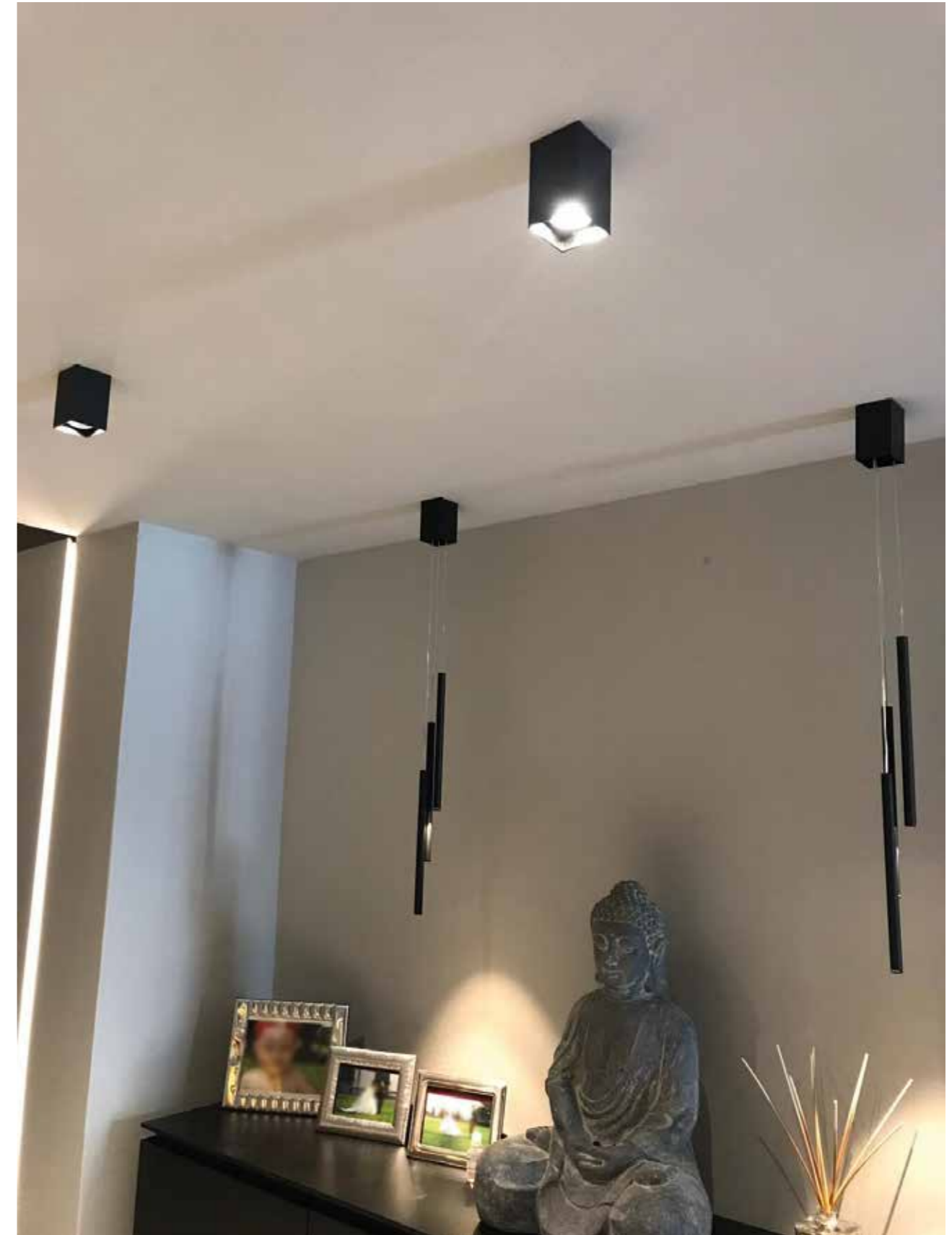

SISTEMI MODULARI MODULAR SYSTEM	LED FLESSIBILI IP20/IP54/IP65 FLEXIBLE LED IP20/IP54/IP65																
	HIGH QUALITY CRI>90 / 95			HIGH OUTPUT CRI> 90 / 95					HIGH EFFICIENT CRI>90 / 95			HIGH INTENSITY CRI>90 / 95		LOW POWER CRI>90	ULTRA SLIM CRI>90 / 95 / 97		
	9,6	14,4	19,2	12,3	14,4	20	24	32	12	19,2	21,6	20	24	6	9,6	12	14,4
K15															■	■	■
K21	■	■	■	■	■	■	■	■	■	■	■	■	■	■	■	■	■
K25	■	■	■	■	■	■	■	■	■	■	■	■	■	■	■	■	■
K40	■	■	■	■	■	■	■	■	■	■	■	■	■	■	■	■	■
Q20	■	■	■	■	■	■	■	■	■	■	■	■	■	■	■	■	■
CH012	■	■	■	■	■	■	■	■	■	■	■	■	■	■	■	■	■
SC015															■	■	■
LC020															■	■	■
LC014	■	■	■	■	■	■	■	■	■	■	■	■	■	■	■	■	■
MS07															■	■	■
MS08															■	■	■
MS09															■	■	■
MC01	■	■		■	■				■					■	■	■	■
MC02	■	■		■	■				■					■	■	■	■
MF01															■	■	■
MF02	■	■		■	■				■					■	■	■	■
STUCTURAE	■	■	■	■	■	■	■	■	■	■	■	■	■	■	■	■	■
U01	■	■	■	■	■	■	■	■	■	■	■	■	■	■	■	■	■
U02/MIRA	■	■	■	■	■	■	■	■	■	■	■	■	■	■	■	■	■
U03	■	■	■	■	■	■	■	■	■	■	■	■	■	■	■	■	■
T24	■	■	■	■	■	■	■	■	■	■	■	■	■	■	■	■	■
KEPLER	■	■	■	■	■	■	■	■	■	■	■	■	■	■	■	■	■
ZER035/35X/35T	■	■	■	■	■	■	■	■	■	■	■	■	■	■	■	■	■
ZER035P/35XP	■	■	■	■	■	■	■	■	■	■	■	■	■	■	■	■	■
ZER055	■	■	■	■	■	■	■	■	■	■	■	■	■	■	■	■	■
ZER065/65P	■	■	■	■	■	■	■	■	■	■	■	■	■	■	■	■	■
ZER066	■	■	■	■	■	■	■	■	■	■	■	■	■	■	■	■	■
ZER075	■	■	■	■	■	■	■	■	■	■	■	■	■	■	■	■	■

SISTEMI MODULARI MODULAR SYSTEM	LED FLESSIBILI IP20/IP54/IP65 FLEXIBLE LED IP20/IP54/IP65							
	NEON CRI>90		NEON SLIM CRI> 90	RGB	RGB WHITE		RGB TW	TUNABLE WHITE
	10	15	8	14,4	14,4	23	14,4	19,2
K15			■					
K21	■	■	■	■	■	■	■	■
K25	■	■	■	■	■	■	■	■
K40	■	■	■	■	■	■	■	■
Q20	■	■	■	■	■	■	■	■
CH012	■	■	■	■	■	■	■	■
SC015			■					
LC020			■					
LC014	■	■	■	■	■	■	■	■
MS07			■					
MS08			■					
MS09			■					
MC01	■	■	■	■	■		■	
MC02	■	■	■	■	■		■	
MF01			■					
MF02	■	■	■	■	■		■	
STUCTURAE	■	■	■	■	■	■	■	■
U01	■	■	■	■	■	■	■	■
U02/MIRA	■	■	■	■	■	■	■	■
U03	■	■	■	■	■	■	■	■
T24	■	■	■	■	■	■	■	■
KEPLER	■	■	■	■	■	■	■	■
ZER035/35X/35T	■	■	■	■	■	■	■	■
ZER035P/35XP	■	■	■	■	■	■	■	■
ZER055	■	■	■	■	■	■	■	■
ZER065/65P	■	■	■	■	■	■	■	■
ZER066	■	■	■	■	■	■	■	■
ZER075	■	■	■	■	■	■	■	■

led new generation + mini flex led

led new generation + mini flex led

designer

luigi cerbone

“temperatura colore costante”

I nuovi led Flessibili, High Quality garantiscono una qualità della temperatura colore costante, che è fondamentale per valorizzare gli ambienti e il comfort visivo. Le Strip Led possono essere impiegate sia per scopi estetici che come fonte di illuminazione vera e propria, soprattutto anche in ambienti dove è sufficiente una luce soffusa e non troppo intensa, ma diffusa (come discoteche, cinema, sale o saloni). Si consiglia di usare le Strip Led in abbinamento ai profili d'alluminio per garantire una migliore dissipazione e un'ottimale durata del prodotto.

The new Flexible, High Quality LEDs guarantee a constant color temperature quality, which is fundamental for enhancing the environments and visual comfort. Strip LEDs can be used both for aesthetic purposes and as a real lighting source, especially even in environments where a soft and not too intense, but diffused light is sufficient (such as discos, cinemas, halls or salons). It is advisable to use the Led Strips in combination with the aluminum profiles to ensure better dissipation and optimal product life.

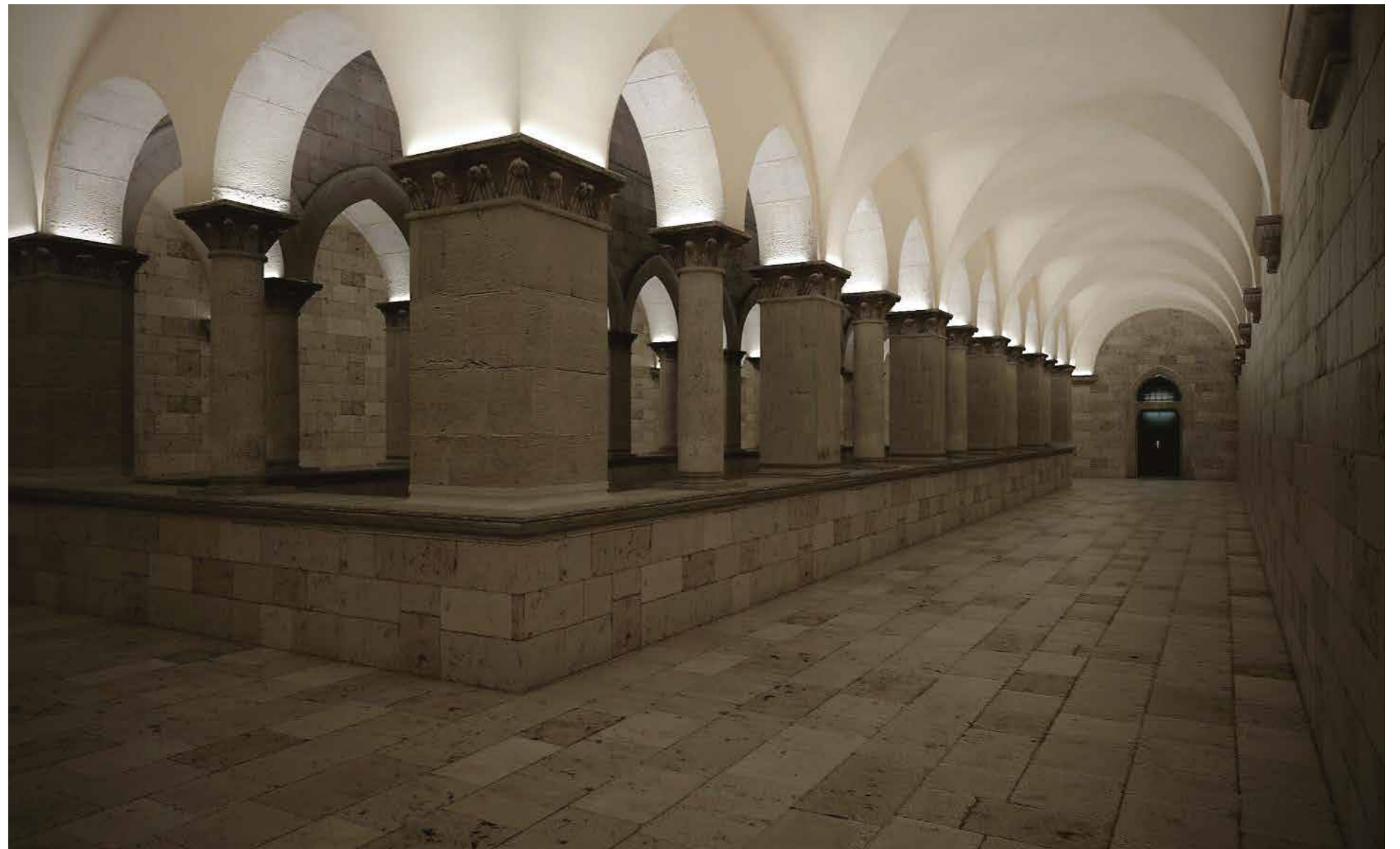

ULTRASLIM 24V - L 1cm - IP20



DIMENSIONE E TAGLIO DIMENSION AND CUT	LED/m LED/m	OUTPUT (lm/W)	WATT (W/m)	IP IP	CRI CRI	LUMEN (lm/m)	CCT CCT	CODICE CODE	RIF. ENERGETICO ENERGY LABEL
 5 X 2 mm ✂ 50 mm	160	120	9,6	20	95	1075	2700 K	9805092921	
						1100	3000 K	9805093221	
						1200	4000 K	9805093921	
 5 X 2 mm ✂ 50 mm	160	115	14,4	20	97	1440	2700 K	9805142921	
						1584	3000 K	9805143221	
						1728	4000 K	9805143921	

HIGH EFFICIENT 24V - L 1cm - IP20



DIMENSIONE E TAGLIO DIMENSION AND CUT	LED/m LED/m	OUTPUT (lm/W)	WATT (W/m)	IP IP	CRI CRI	LUMEN (lm/m)	CCT CCT	CODICE CODE	RIF. ENERGETICO ENERGY LABEL
 8 X 2 mm ✂ 63 mm	160	115	14,4	20	95	142	2700 K	9824142921	
						158	3000 K	9824143221	
						164	3500 K	9824143521	
						174	4000 K	9824143921	
 10 X 2 mm ✂ 72 mm	126	200	14,4	20	90	2650	2700 K	98HE142721	
						2740	3000 K	98HE143021	
						2880	4000 K	98HE144221	
 10 X 2 mm ✂ 50 mm	180	200	19,2	20	90	3650	2700 K	98HE192721	
						3700	3000 K	98HE193021	
						3840	4000 K	98HE194221	
 8 X 2 mm ✂ 63 mm	176	125	24	20	95	2856	2700 K	9824232921	
						2975	3000 K	9824233221	
						3094	4000 K	9824233921	
 8 X 2 mm ✂ 63 mm	240	125	33	20	90	3680	2700 K	98HE322721	
						4000	3000 K	98HE323021	
						4160	4000 K	98HE324221	

LAVORAZIONI / PROCESSING

DATI TECNICI
TECHNICAL DATACABLAGGIO - COLLAUDO - LED IP > 20
INSTALLATION AND TESTING LED >20CABLAGGIO - COLLAUDO - LED IP > 20 DOPPIA ALIMENTAZIONE
INSTALLATION AND TESTING LED IP>20 POWER SUPPLYCODICE
CODE

98LEDIP

98LEDIP2

Temperatura +/- 100 K - 3 step MacAdam / Temperature +/- 100 K - 3 MacAdam steps

ULTRASLIM 24V - L 5m - IP20



DIMENSIONE E TAGLIO DIMENSION AND CUT	LED/m LED/m	OUTPUT (lm/W)	WATT (W/m)	IP IP	CRI CRI	LUMEN (lm/m)	CCT CCT	CODICE CODE	RIF. ENERGETICO ENERGY LABEL
 5 X 2 mm ✂ 50 mm	160	120	9,6	20	95	1075	2700 K	9805092920	
						1100	3000 K	9805093220	
						1200	4000 K	9805093920	
 5 X 2 mm ✂ 50 mm	160	115	14,4	20	97	1440	2700 K	9805142920	
						1584	3000 K	9805143220	
						1728	4000 K	9805143920	

HIGH EFFICIENT 24V - L 5m - IP20



DIMENSIONE E TAGLIO DIMENSION AND CUT	LED/m LED/m	OUTPUT (lm/W)	WATT (W/m)	IP IP	CRI CRI	LUMEN (lm/m)	CCT CCT	CODICE CODE	RIF. ENERGETICO ENERGY LABEL
 8 X 2 mm ✂ 63 mm	160	115	14,4	20	95	142	2700 K	9824142920	
						158	3000 K	9824143220	
						164	3500 K	9824143521	
						174	4000 K	9824143920	
 10 X 2 mm ✂ 72 mm	126	200	14,4	20	90	2650	2700 K	98HE142720	
						2740	3000 K	98HE143020	
						2880	4000 K	98HE144220	
 10 X 2 mm ✂ 50 mm	180	200	19,2	20	90	3650	2700 K	98HE192720	
						3700	3000 K	98HE193020	
						3840	4000 K	98HE194220	
 8 X 2 mm ✂ 63 mm	160	125	24	20	95	2856	2700 K	9824232920	
						2975	3000 K	9824233220	
						3094	4000 K	9824233920	
 8 X 2 mm ✂ 63 mm	240	125	33	20	90	3680	2700 K	98HE322720	
						4000	3000 K	98HE323020	
						4160	4000 K	98HE324220	

Temperatura +/- 100 K - 3 step MacAdam / Temperature +/- 100 K - 3 MacAdam steps

HIGH EFFICIENT 48V - L 1cm - IP20



DIMENSIONE E TAGLIO DIMENSION AND CUT	LED/m LED/m	OUTPUT (lm/W)	WATT (W/m)	IP IP	CRI CRI	LUMEN (lm/m)	CCT CCT	CODICE CODE	RIF. ENERGETICO ENERGY LABEL
 8 X 2 mm ✂ 25 mm L. max = 20m	60	105	11,4	20	94	1200	2700 K	9848122721	
						1260	3000 K	9848123021	
						1360	4000 K	9848124221	
 10 X 2 mm ✂ 15 mm L. max = 20m	120	115	7,6	20	90	790	2700 K	9848082721	
						840	3000 K	9848083021	
						880	4000 K	9848084221	

driver 48V ip20

DATI TECNICI
TECHNICAL DATA

Tensione/Voltage: 48V - CC SELV / 220-240v - 50-60 Hz
 Power Factor > 0.9 at > 50% load
 DC Operation 176-264v DC
 Ambient Temperature: -15°C to 60°C
 Weight: 0.20 - 1.50 Kg

DIMENSIONI (ln x lg x h) DIMENSIONS	POTENZA POWER	CODICE CODE
 60 x 225 x 36	50 W	980504
 60 x 240 x 49	70 W	980704
 60 x 240 x 49	150 W	981504

TENSIONE DI RETE - L 1cm - IP65



DIMENSIONE E TAGLIO DIMENSION AND CUT	LED/m LED/m	OUTPUT (lm/W)	WATT (W/m)	IP IP	CRI CRI	LUMEN (lm/m)	CCT CCT	CODICE CODE	RIF. ENERGETICO ENERGY LABEL
 10 X 2 mm ✂ 100 mm L. max = 50m	120	100	16	65	90	1150	2700 K	9823162761	
						1200	3000 K	9823163061	
						1300	4000 K	9823164261	

TENSIONE DI RETE ACCESSORI / ACCESSORIES



TESTATA / END CAP INDOOR & OUTDOOR
 CODICE / CODE 982300



TESTATA CON CAVO DI ALIMENTAZIONE /
 END CAP WITH POWER CORD
 CODICE / CODE 982301

TENSIONE DI RETE CONNETTORI / CONNECTORS



CONNETTORE AD "L" /
 L SNAP CONNECTOR INDOOR
 CODICE / CODE 982302



CONNETTORE A SPINA /
 SPLICE CONNECTOR INDOOR
 CODICE / CODE 982303



CONNETTORE A SPINA CON CAVO /
 JUMPER INDOOR & OUTDOOR
 CODICE / CODE 982304



TESTATA DI CHIUSURA CON CAVO DI ALIMENTAZIONE E SPINA /
 END CAP WITH POWER PLUG INDOOR
 CODICE / CODE 982305

ULTRASLIM 24V - L 1cm - IP65



DIMENSIONE E TAGLIO DIMENSION AND CUT	LED/m LED/m	OUTPUT (lm/W)	WATT (W/m)	IP IP	CRI CRI	LUMEN (lm/m)	CCT CCT	CODICE CODE	RIF. ENERGETICO ENERGY LABEL
 5 X 2 mm ✂ 50 mm	160	120	9,6	65	95	1075	2700 K	9805092961	F
						1100	3000 K	9805093261	
						1200	4000 K	9805093961	
 5 X 2 mm ✂ 50 mm	160	115	14,4	65	97	1440	2700 K	9805142961	F
						1584	3000 K	9805143261	
						1728	4000 K	9805143961	

HIGH EFFICIENT 24V - L 1cm - IP65



DIMENSIONE E TAGLIO DIMENSION AND CUT	LED/m LED/m	OUTPUT (lm/W)	WATT (W/m)	IP IP	CRI CRI	LUMEN (lm/m)	CCT CCT	CODICE CODE	RIF. ENERGETICO ENERGY LABEL
 8 X 2 mm ✂ 63 mm	160	115	14,4	65	95	1426	2700 K	9824142961	F
						1584	3000 K	9824143261	
						1740	4000 K	9824143961	
 10 X 2 mm ✂ 72 mm	126	200	14,4	65	90	2650	2700 K	98HE142761	C
						2740	3000 K	98HE143061	
						2880	4000 K	98HE144261	
 10 X 2 mm ✂ 50 mm	180	200	19,2	65	90	3650	2700 K	98HE192761	C
						3700	3000 K	98HE193061	
						3840	4000 K	98HE194261	
 8 X 2 mm ✂ 63 mm	176	125	24	65	95	2856	2700 K	9824232961	E
						2975	3000 K	9824233261	
						3094	4000 K	9824233961	
 8 X 2 mm ✂ 63 mm	240	125	33	65	90	3680	2700 K	98HE322761	F
						4000	3000 K	98HE323061	
						4160	4000 K	98HE324261	

LAVORAZIONI / PROCESSING

DATI TECNICI
TECHNICAL DATACABLAGGIO - COLLAUDO - LED IP > 20
INSTALLATION AND TESTING LED >20CABLAGGIO - COLLAUDO - LED IP > 20 DOPPIA ALIMENTAZIONE
INSTALLATION AND TESTING LED IP>20 POWER SUPPLYCABLAGGIO - COLLAUDO - LED IP20 DOPPIA ALIMENTAZIONE
INSTALLATION AND TESTING LED POWER SUPPLYCODICE
CODE

98LEDIP

98LEDIP2

98LED2

Temperatura +/- 100 K - 3 step MacAdam / Temperature +/- 100 K - 3 MacAdam steps

ULTRASLIM 24V - L 5m - IP65



DIMENSIONE E TAGLIO DIMENSION AND CUT	LED/m LED/m	OUTPUT (lm/W)	WATT (W/m)	IP IP	CRI CRI	LUMEN (lm/m)	CCT CCT	CODICE CODE	RIF. ENERGETICO ENERGY LABEL
 5 X 2 mm ✂ 50 mm	160	165	9,6	65	95	1075	2700 K	9805092965	F
						1100	3000 K	9805093265	
						1650	4000 K	9805093965	
 5 X 2 mm ✂ 50 mm	160	115	14,4	65	97	1440	2700 K	9805142965	F
						1584	3000 K	9805143265	
						1728	4000 K	9805143965	

HIGH EFFICIENT 24V - L 5m - IP65



DIMENSIONE E TAGLIO DIMENSION AND CUT	LED/m LED/m	OUTPUT (lm/W)	WATT (W/m)	IP IP	CRI CRI	LUMEN (lm/m)	CCT CCT	CODICE CODE	RIF. ENERGETICO ENERGY LABEL
 8 X 2 mm ✂ 63 mm	160	115	14,4	65	95	1426	2700 K	9824142965	F
						1584	3000 K	9824143265	
						1740	4000 K	9824143965	
 10 X 2 mm ✂ 72 mm	126	200	14,4	65	90	2650	2700 K	98HE142765	C
						2740	3000 K	98HE143065	
						2880	4000 K	98HE144265	
 10 X 2 mm ✂ 50 mm	180	200	19,2	65	90	3650	2700 K	98HE192765	C
						3700	3000 K	98HE193065	
						3840	4000 K	98HE194265	
 8 X 2 mm ✂ 63 mm	160	125	24	65	95	2856	2700 K	9824232965	E
						2975	3000 K	9824233265	
						3094	4000 K	9824233965	
 8 X 2 mm ✂ 63 mm	240	125	33	65	90	3680	2700 K	98HE322765	F
						4000	3000 K	98HE323065	
						4160	4000 K	98HE324265	

Temperatura +/- 100 K - 3 step MacAdam / Temperature +/- 100 K - 3 MacAdam steps

flex led ip66

personalizzazione

custom

FLEX LED - L 5m - IP66



DIMENSIONE E TAGLIO DIMENSION AND CUT	LED/m LED/m	WATT (W/m)	IP IP	CRI CRI	LUMEN (lm/m)	CCT CCT	CODICE CODE	RIF. ENERGETICO ENERGY LABEL
 10 X 10 mm ✂ 50 mm	140	14,4	66	90	1180	3000 K	9924153066	

 11 X 10 mm ✂ 50 mm	140	19,2	66	90	1570	3000 K	9924203066	
---------------------------	-----	------	----	----	------	--------	------------	--

FLEX LED - L 1cm - IP66



DIMENSIONE E TAGLIO DIMENSION AND CUT	LED/m LED/m	WATT (W/m)	IP IP	CRI CRI	LUMEN (lm/m)	CCT CCT	CODICE CODE	RIF. ENERGETICO ENERGY LABEL
 6,40 X 10,80 mm ✂ 50 mm	140	14,4	66	90	1180	3000 K	9924153061	

 6,40 X 10,80 mm ✂ 50 mm	140	19,2	66	90	1570	3000 K	9924203061	
--------------------------------	-----	------	----	----	------	--------	------------	--

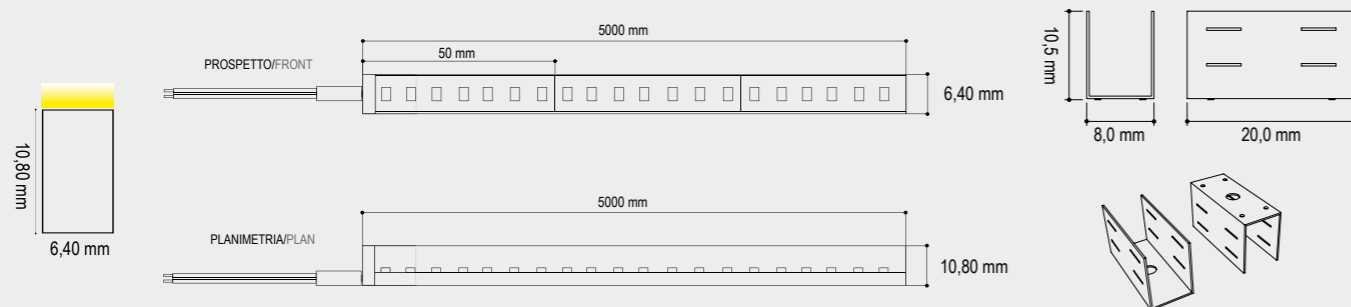

flex led ip65

personalizzazione

custom

FLEX LED 3D - L 5m - IP65



DIMENSIONE E TAGLIO DIMENSION AND CUT	LED/m LED/m	WATT (W/m)	IP IP	CRI CRI	LUMEN (lm/m)	CCT CCT	CODICE CODE	RIF. ENERGETICO ENERGY LABEL
 9,35 X 9,60 mm ✂ 50 mm	240	14,4	65	90	1160	2700 K	98NE152765	
					1180	3000 K	98NE153065	
					1200	4000 K	98NE154265	

FLEX LED 3D - L 1cm - IP65



DIMENSIONE E TAGLIO DIMENSION AND CUT	LED/m LED/m	WATT (W/m)	IP IP	CRI CRI	LUMEN (lm/m)	CCT CCT	CODICE CODE	RIF. ENERGETICO ENERGY LABEL
 9,35 X 9,60 mm ✂ 50 mm	240	14,4	65	90	1160	2700 K	98NE152761	
					1180	3000 K	98NE153061	
					1200	4000 K	98NE154261	

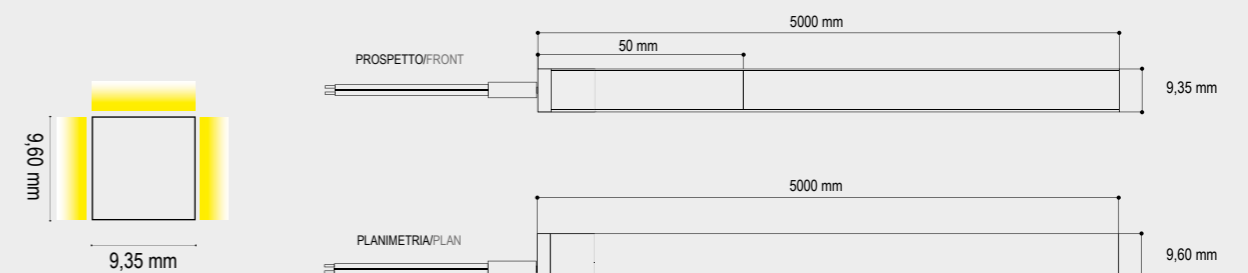

MINI FLEX LED - L 3m - IP65



DIMENSIONE E TAGLIO DIMENSION AND CUT	LED/m LED/m	WATT (W/m)	IP IP	CRI CRI	LUMEN (lm/m)	CCT CCT	CODICE CODE	RIF. ENERGETICO ENERGY LABEL
 6 X 12 mm ✂ 50 mm	182	14,4	65	90	1160	2700 K	9905152765	
					1180	3000 K	9905153065	
					1200	4000 K	9905154265	

MINI FLEX LED - L 1cm - IP65



DIMENSIONE E TAGLIO DIMENSION AND CUT	LED/m LED/m	WATT (W/m)	IP IP	CRI CRI	LUMEN (lm/m)	CCT CCT	CODICE CODE	RIF. ENERGETICO ENERGY LABEL
 6 X 12 mm ✂ 50 mm	182	14,4	65	90	1160	2700 K	9905152761	
					1180	3000 K	9905153061	
					1200	4000 K	9905154261	

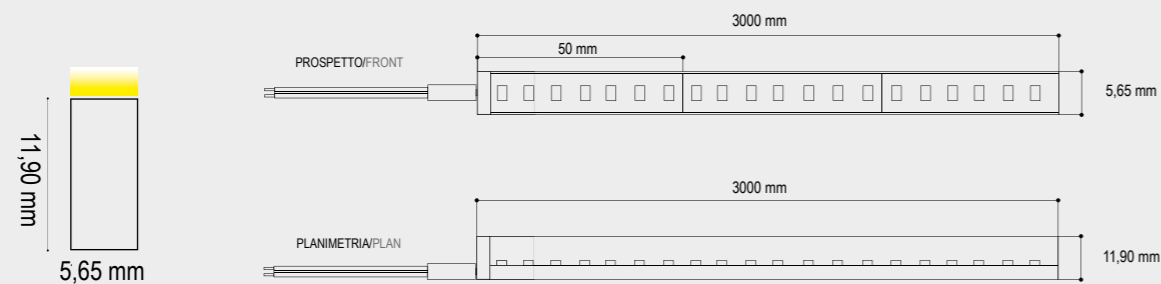

NEON - 24V - L 1cm - IP20



DIMENSIONE E TAGLIO DIMENSION AND CUT	LED/m LED/m	OUTPUT (lm/W)	WATT (W/m)	IP IP	CRI CRI	LUMEN (lm/m)	CCT CCT	CODICE CODE	RIF. ENERGETICO ENERGY LABEL
 8 X 2 mm ✂ 50 mm		90	10,0	20	90	880	2700 K	98CB102721	
						900	3000 K	98CB103021	
						930	4000 K	98CB104221	
 10 X 2 mm ✂ 50 mm		90	15,0	20	90	1320	2700 K	98CB152721	
						1350	3000 K	98CB153021	
						1390	4000 K	98CB154221	

NEON - 24V - L 1cm - IP67



DIMENSIONE E TAGLIO DIMENSION AND CUT	LED/m LED/m	OUTPUT (lm/W)	WATT (W/m)	IP IP	CRI CRI	LUMEN (lm/m)	CCT CCT	CODICE CODE	RIF. ENERGETICO ENERGY LABEL
 12 X 2 mm ✂ 50 mm		85	15,0	67	90	1245	2700 K	98CB152761	
						1275	3000 K	98CB153061	
						1320	4000 K	98CB154261	

NEON SLIM - 24V - L 1cm - IP20



DIMENSIONE E TAGLIO DIMENSION AND CUT	LED/m LED/m	OUTPUT (lm/W)	WATT (W/m)	IP IP	CRI CRI	LUMEN (lm/m)	CCT CCT	CODICE CODE	RIF. ENERGETICO ENERGY LABEL
 4 X 2 mm ✂ 50 mm		95	8,0	20	90	744	2700 K	98CB042721	
						760	3000 K	98CB043021	
						840	4000 K	98CB044221	

Temperatura +/- 100 K - 3 step MacAdam / Temperature +/- 100 K - 3 MacAdam steps

LAVORAZIONI / PROCESSING

DATI TECNICI
TECHNICAL DATACABLAGGIO - COLLAUDO - LED IP > 20
INSTALLATION AND TESTING LED >20CABLAGGIO - COLLAUDO - LED IP > 20 DOPPIA ALIMENTAZIONE
INSTALLATION AND TESTING LED IP>20 POWER SUPPLYCABLAGGIO - COLLAUDO - LED IP20 DOPPIA ALIMENTAZIONE
INSTALLATION AND TESTING LED POWER SUPPLYCODICE
CODE

98LEDIP

98LEDIP2

98LED2

NEON - 24V - L 5m - IP20



DIMENSIONE E TAGLIO DIMENSION AND CUT	LED/m LED/m	OUTPUT (lm/W)	WATT (W/m)	IP IP	CRI CRI	LUMEN (lm/m)	CCT CCT	CODICE CODE	RIF. ENERGETICO ENERGY LABEL
 8 X 2 mm ✂ 50 mm		90	10,0	20	90	880	2700 K	98CB102720	
						900	3000 K	98CB103020	
						930	4000 K	98CB104220	
 10 X 2 mm ✂ 50 mm		90	15,0	20	90	1320	2700 K	98CB152720	
						1350	3000 K	98CB153020	
						1390	4000 K	98CB154220	

NEON - 24V - L 5m - IP67



DIMENSIONE E TAGLIO DIMENSION AND CUT	LED/m LED/m	OUTPUT (lm/W)	WATT (W/m)	IP IP	CRI CRI	LUMEN (lm/m)	CCT CCT	CODICE CODE	RIF. ENERGETICO ENERGY LABEL
 12 X 2 mm ✂ 50 mm		85	15,0	67	90	1245	2700 K	98CB152765	
						1275	3000 K	98CB153065	
						1320	4000 K	98CB154265	

NEON SLIM - 24V - L 5m - IP20



DIMENSIONE E TAGLIO DIMENSION AND CUT	LED/m LED/m	OUTPUT (lm/W)	WATT (W/m)	IP IP	CRI CRI	LUMEN (lm/m)	CCT CCT	CODICE CODE	RIF. ENERGETICO ENERGY LABEL
 4 X 2 mm ✂ 50 mm		95	8,0	20	90	744	2700 K	98CB042720	
						760	3000 K	98CB043020	
						840	4000 K	98CB044220	

Temperatura +/- 100 K - 3 step MacAdam / Temperature +/- 100 K - 3 MacAdam steps

high output

personalizzazione

custom

24V - L 1cm - IP20



DIMENSIONE E TAGLIO DIMENSION AND CUT	LED/m LED/m	OUTPUT (lm/W)	WATT (W/m)	IP IP	CRI CRI	LUMEN (lm/m)	CCT CCT	CODICE CODE	RIF. ENERGETICO ENERGY LABEL
 8 X 2 mm ✂ 63 mm	128	115	12,3	20	90	1350	2700 K	98HO122721	
						1400	3000 K	98HO123021	
						1450	4000 K	98HO124221	
 8 X 2 mm ✂ 63 mm	280	110	20	20	90	2100	2700 K	98HO202721	
						2200	3000 K	98HO203021	
						2350	4000 K	98HO204221	
 10 X 2 mm ✂ 33 mm	180	105	14,4	20	95	1500	2700 K	98HO152921	
						1550	3000 K	98HO153221	
						1590	4000 K	98HO153921	
 10 X 2 mm ✂ 25 mm	240	110	19,2	20	95	2050	2700 K	98HO202921	
						2100	3000 K	98HO203221	
						2200	4000 K	98HO203921	
 10 X 2 mm ✂ 100 mm	60	90	14,4	20	95	1250	2700 K	9824152921	
						1280	3000 K	9824153221	
						1300	4000 K	9824153921	
 10 X 2 mm ✂ 100 mm	120	105	24	20	95	2500	2700 K	9824242921	
						2530	3000 K	9824243221	
						2560	4000 K	9824243921	
 10 X 2 mm ✂ 100 mm	240	105	24	20	95	2500	2700 K	98HO242921	
						2530	3000 K	98HO243221	
						2560	4000 K	98HO243921	
 10 X 2 mm ✂ 33 mm	240	100	20	20	97	2000	2700 K	97HO202921	
						2050	3000 K	97HO203221	
						2100	4000 K	97HO204221	

HIGH OUTPUT - 24V - 2500 K - L 1cm - IP20



DIMENSIONE E TAGLIO DIMENSION AND CUT	LED/m LED/m	OUTPUT (lm/W)	WATT (W/m)	IP IP	CRI CRI	LUMEN (lm/m)	CCT CCT	CODICE CODE	RIF. ENERGETICO ENERGY LABEL
 10 X 2 mm ✂ 50 mm	240	105	19,2	20	90	1470	2500 K	98HO202621	

Temperatura +/- 100 K - 3 step MacAdam / Temperature +/- 100 K - 3 MacAdam steps

high output

personalizzazione

custom

24V - L 5m - IP20



DIMENSIONE E TAGLIO DIMENSION AND CUT	LED/m LED/m	OUTPUT (lm/W)	WATT (W/m)	IP IP	CRI CRI	LUMEN (lm/m)	CCT CCT	CODICE CODE	RIF. ENERGETICO ENERGY LABEL
 8 X 2 mm ✂ 63 mm	128	115	12,3	20	90	1350	2700 K	98HO122720	
						1400	3000 K	98HO123020	
						1450	4000 K	98HO124220	
 8 X 2 mm ✂ 63 mm	280	110	20	20	90	2100	2700 K	98HO202720	
						2200	3000 K	98HO203020	
						2350	4000 K	98HO204220	
 10 X 2 mm ✂ 33 mm	180	105	14,4	20	95	1500	2700 K	98HO152920	
						1550	3000 K	98HO153220	
						1590	4000 K	98HO153920	
 10 X 2 mm ✂ 25 mm	240	110	19,2	20	95	2050	2700 K	98HO202920	
						2100	3000 K	98HO203220	
						2200	4000 K	98HO203920	
 10 X 2 mm ✂ 100 mm	60	90	14,4	20	95	1250	2700 K	9824152920	
						1280	3000 K	9824153220	
						1300	4000 K	9824153920	
 10 X 2 mm ✂ 100 mm	120	105	24	20	95	2500	2700 K	9824242920	
						2530	3000 K	9824243220	
						2560	4000 K	9824243920	
 10 X 2 mm ✂ 100 mm	240	105	24	20	95	2500	2700 K	98HO242920	
						2530	3000 K	98HO243220	
						2560	4000 K	98HO243920	
 10 X 2 mm ✂ 33 mm	240	100	20	20	97	2000	2700 K	97HO202920	
						2050	3000 K	97HO203220	
						2100	4000 K	97HO204220	

HIGH OUTPUT - 24V - 2500 K - L 5m - IP20



DIMENSIONE E TAGLIO DIMENSION AND CUT	LED/m LED/m	OUTPUT (lm/W)	WATT (W/m)	IP IP	CRI CRI	LUMEN (lm/m)	CCT CCT	CODICE CODE	RIF. ENERGETICO ENERGY LABEL
 10 X 2 mm ✂ 50 mm	240	105	19,2	20	90	1470	2500 K	98HO202620	

Temperatura +/- 100 K - 3 step MacAdam / Temperature +/- 100 K - 3 MacAdam steps

high output

personalizzazione

custom

24V - L 1cm - IP65



DIMENSIONE E TAGLIO DIMENSION AND CUT	LED/m LED/m	OUTPUT (lm/W)	WATT (W/m)	IP IP	CRI CRI	LUMEN (lm/m)	CCT CCT	CODICE CODE	RIF. ENERGETICO ENERGY LABEL
8 X 2 mm ✂ 50 mm	128	105	12,3	65	90	1400	2700 K	98HO122761	F
						1470	3000 K	98HO123061	
						1530	4000 K	98HO124261	
10 X 2 mm ✂ 33 mm	280	105	20	65	90	2100	2700 K	98HO202761	F
						2200	3000 K	98HO203061	
						2350	4000 K	98HO204261	
10 X 2 mm ✂ 100 mm	120	105	24	65	95	2500	2700 K	9824242961	F
						2530	3000 K	9824243261	
						2560	4000 K	9824243961	

HIGH QUALITY - 24V - L 1cm - IP20



DIMENSIONE E TAGLIO DIMENSION AND CUT	LED/m LED/m	OUTPUT (lm/W)	WATT (W/m)	IP IP	CRI CRI	LUMEN (lm/m)	CCT CCT	CODICE CODE	RIF. ENERGETICO ENERGY LABEL
8 X 2 mm ✂ 50 mm	120	85	9,6	20	90	780	2700 K	9824102721	G
						800	3000 K	9824103021	
						820	4000 K	9824104221	
8 X 2 mm ✂ 33 mm	180	85	14,4	20	90	1170	2700 K	9824152721	G
						1200	3000 K	9824153021	
						1230	4000 K	9824154221	
10 X 2 mm ✂ 25 mm	240	85	19,2	20	90	1560	2700 K	9824202721	G
						1600	3000 K	9824203021	
						1640	4000 K	9824204221	

HIGH QUALITY - 24V - L 1cm - IP65



DIMENSIONE E TAGLIO DIMENSION AND CUT	LED/m LED/m	OUTPUT (lm/W)	WATT (W/m)	IP IP	CRI CRI	LUMEN (lm/m)	CCT CCT	CODICE CODE	RIF. ENERGETICO ENERGY LABEL
8 X 2 mm ✂ 50 mm	120	80	9,6	65	90	760	2700 K	9824102761	G
						770	3000 K	9824103061	
						780	4000 K	9824104261	
8 X 2 mm ✂ 33 mm	180	80	14,4	65	90	1170	2700 K	9824152761	G
						1180	3000 K	9824153061	
						1190	4000 K	9824154261	
10 X 2 mm ✂ 25 mm	240	80	19,2	65	90	1550	2700 K	9824202761	G
						1570	3000 K	9824203061	
						1610	4000 K	9824204261	

Temperatura +/- 100 K - 3 step MacAdam / Temperature +/- 100 K - 3 MacAdam steps

high output

personalizzazione

custom

24V - L 5m - IP65



DIMENSIONE E TAGLIO DIMENSION AND CUT	LED/m LED/m	OUTPUT (lm/W)	WATT (W/m)	IP IP	CRI CRI	LUMEN (lm/m)	CCT CCT	CODICE CODE	RIF. ENERGETICO ENERGY LABEL
8 X 2 mm ✂ 50 mm	128	105	12,3	65	90	1400	2700 K	98HO122765	F
						1470	3000 K	98HO123065	
						1530	4000 K	98HO124265	
10 X 2 mm ✂ 33 mm	280	105	20	65	90	2100	2700 K	98HO202765	F
						2200	3000 K	98HO203065	
						2350	4000 K	98HO204265	
10 X 2 mm ✂ 100 mm	120	105	24	65	95	2500	2700 K	9824242965	F
						2530	3000 K	9824243265	
						2560	4000 K	9824243965	

HIGH QUALITY - 24V - L 5m - IP20



DIMENSIONE E TAGLIO DIMENSION AND CUT	LED/m LED/m	OUTPUT (lm/W)	WATT (W/m)	IP IP	CRI CRI	LUMEN (lm/m)	CCT CCT	CODICE CODE	RIF. ENERGETICO ENERGY LABEL
8 X 2 mm ✂ 50 mm	120	85	9,6	20	90	780	2700 K	9824102720	G
						800	3000 K	9824103020	
						820	4000 K	9824104220	
8 X 2 mm ✂ 33 mm	180	85	14,4	20	90	1170	2700 K	9824152720	G
						1200	3000 K	9824153020	
						1230	4000 K	9824154220	
10 X 2 mm ✂ 25 mm	240	85	19,2	20	90	1560	2700 K	9824202720	G
						1600	3000 K	9824203020	
						1640	4000 K	9824204220	

HIGH QUALITY - 24V - L 5m - IP65



DIMENSIONE E TAGLIO DIMENSION AND CUT	LED/m LED/m	OUTPUT (lm/W)	WATT (W/m)	IP IP	CRI CRI	LUMEN (lm/m)	CCT CCT	CODICE CODE	RIF. ENERGETICO ENERGY LABEL
8 X 2 mm ✂ 50 mm	120	80	9,6	65	90	760	2700 K	9824102765	G
						770	3000 K	9824103065	
						780	4000 K	9824104265	
8 X 2 mm ✂ 33 mm	180	80	14,4	65	90	1170	2700 K	9824152765	G
						1180	3000 K	9824153065	
						1190	4000 K	9824154265	
10 X 2 mm ✂ 25 mm	240	80	19,2	65	90	1550	2700 K	9824202765	G
						1570	3000 K	9824203065	
						1610	4000 K	9824204265	

Temperatura +/- 100 K - 3 step MacAdam / Temperature +/- 100 K - 3 MacAdam steps

HIGH EFFICIENT - 24V - L 1cm - IP20



DIMENSIONE E TAGLIO DIMENSION AND CUT	LED/m LED/m	OUTPUT (lm/W)	WATT (W/m)	IP IP	CRI CRI	LUMEN (lm/m)	CCT CCT	CODICE CODE	RIF. ENERGETICO ENERGY LABEL
 10 X 2 mm ✂ 70 mm	160	150	12	20	90	1750	2700 K	98HE122721	
						1800	3000 K	98HE123021	
						1850	4000 K	98HE124221	
 8 X 2 mm ✂ 63 mm	112	150	19,2	20	90	2800	2700 K	98HE202721	
						2840	3000 K	98HE203021	
						2890	4000 K	98HE204221	
 10 X 2 mm ✂ 33 mm	240	140	21,6	20	90	3025	2700 K	98HE212721	
						3075	3000 K	98HE213021	
						3125	4000 K	98HE214221	
 10 X 2 mm ✂ 33 mm	240	135	21,6	20	95	2050	2700 K	98HE212921	
						2100	3000 K	98HE213221	
						2200	4000 K	98HE213921	

HIGH EFFICIENT - 24V - L 1cm - IP54



DIMENSIONE E TAGLIO DIMENSION AND CUT	LED/m LED/m	OUTPUT (lm/W)	WATT (W/m)	IP IP	CRI CRI	LUMEN (lm/m)	CCT CCT	CODICE CODE	RIF. ENERGETICO ENERGY LABEL
 10 X 2 mm ✂ 33 mm	240	135	21,6	54	90	2870	2700 K	98HE212751	
						2920	3000 K	98HE213051	
						2970	4000 K	98HE214251	
 10 X 2 mm ✂ 33 mm	240	135	21,6	54	95	2870	2700 K	98HE212951	
						2920	3000 K	98HE213251	
						2970	4000 K	98HE213951	

HIGH INTENSITY - 24V - L 1cm - IP20



DIMENSIONE E TAGLIO DIMENSION AND CUT	LED/m LED/m	OUTPUT (lm/W)	WATT (W/m)	IP IP	CRI CRI	LUMEN (lm/m)	CCT CCT	CODICE CODE	RIF. ENERGETICO ENERGY LABEL
 10 X 2 mm ✂ 10 mm	700	90	24	20	90	2110	2700 K	98HI242921	
						2160	3000 K	98HI243221	
						2210	4000 K	98HI244221	
 10 X 2 mm ✂ 35 mm	280	90	24	20	90	2110	2700 K	98HI242721	
						2160	3000 K	98HI243021	
						2210	4000 K	98HI244221	

HIGH EFFICIENT - 24V - L 5m - IP20



DIMENSIONE E TAGLIO DIMENSION AND CUT	LED/m LED/m	OUTPUT (lm/W)	WATT (W/m)	IP IP	CRI CRI	LUMEN (lm/m)	CCT CCT	CODICE CODE	RIF. ENERGETICO ENERGY LABEL
 10 X 2 mm ✂ 70 mm	160	150	12	20	90	1750	2700 K	98HE122720	
						1800	3000 K	98HE123020	
						1850	4000 K	98HE124220	
 8 X 2 mm ✂ 63 mm	112	150	19,2	20	90	2800	2700 K	98HE202720	
						2840	3000 K	98HE203020	
						2890	4000 K	98HE204220	
 10 X 2 mm ✂ 33 mm	240	140	21,6	20	90	3025	2700 K	98HE212720	
						3075	3000 K	98HE213020	
						3125	4000 K	98HE214220	
 10 X 2 mm ✂ 33 mm	240	135	21,6	20	95	2050	2700 K	98HE212920	
						2100	3000 K	98HE213220	
						2200	4000 K	98HE213920	

HIGH EFFICIENT - 24V - L 5m - IP54



DIMENSIONE E TAGLIO DIMENSION AND CUT	LED/m LED/m	OUTPUT (lm/W)	WATT (W/m)	IP IP	CRI CRI	LUMEN (lm/m)	CCT CCT	CODICE CODE	RIF. ENERGETICO ENERGY LABEL
 10 X 2 mm ✂ 33 mm	240	135	21,6	54	90	2870	2700 K	98HE212754	
						2920	3000 K	98HE213054	
						2970	4000 K	98HE214254	
 10 X 2 mm ✂ 33 mm	240	135	21,6	54	95	2870	2700 K	98HE212954	
						2920	3000 K	98HE213254	
						2970	4000 K	98HE213954	

HIGH INTENSITY - 24V - L 5m - IP20



DIMENSIONE E TAGLIO DIMENSION AND CUT	LED/m LED/m	OUTPUT (lm/W)	WATT (W/m)	IP IP	CRI CRI	LUMEN (lm/m)	CCT CCT	CODICE CODE	RIF. ENERGETICO ENERGY LABEL
 10 X 2 mm ✂ 10 mm	700	90	24	20	90	2110	2700 K	98HI242920	
						2160	3000 K	98HI243220	
						2210	4000 K	98HI244220	
 10 X 2 mm ✂ 35 mm	280	90	24	20	90	2110	2700 K	98HI242720	
						2160	3000 K	98HI243020	
						2210	4000 K	98HI244220	

LOW POWER - 24V - L 1cm - IP20



DIMENSIONE E TAGLIO DIMENSION AND CUT	LED/m LED/m	OUTPUT (lm/W)	WATT (W/m)	IP IP	CRI CRI	LUMEN (lm/m)	CCT CCT	CODICE CODE	RIF. ENERGETICO ENERGY LABEL
 10 X 2 mm ✂ 50 mm	140	105	6	20	90	770	2700 K	9824LP2721	
						800	3000 K	9824LP3021	
						840	4000 K	9824LP4221	

LOW POWER - 24V - L 1cm - IP65



DIMENSIONE E TAGLIO DIMENSION AND CUT	LED/m LED/m	OUTPUT (lm/W)	WATT (W/m)	IP IP	CRI CRI	LUMEN (lm/m)	CCT CCT	CODICE CODE	RIF. ENERGETICO ENERGY LABEL
 10 X 2 mm ✂ 50 mm	140	105	6	65	90	770	2700 K	98LP062761	
						800	3000 K	98LP063061	
						840	4000 K	98LP064261	

ULTRA SLIM - 24V - L 1cm - IP20



DIMENSIONE E TAGLIO DIMENSION AND CUT	LED/m LED/m	OUTPUT (lm/W)	WATT (W/m)	IP IP	CRI CRI	LUMEN (lm/m)	CCT CCT	CODICE CODE	RIF. ENERGETICO ENERGY LABEL
 5 X 2 mm ✂ 50 mm	120	85	9,6	20	90	780	2700 K	9805102721	
						800	3000 K	9805103021	
						820	4000 K	9805104221	

 5 X 2 mm ✂ 33 mm	180	85	14,4	20	90	1170	2700 K	9805152721	
						1200	3000 K	9805153021	
						1230	4000 K	9805154221	

 5 X 2 mm ✂ 50 mm	120	85	9,6	20	95	770	2700 K	9805102921	
						790	3000 K	9805103221	
						810	4000 K	9805103921	

 5 X 2 mm ✂ 33 mm	180	85	14,4	20	95	1170	2700 K	9805152921	
						1190	3000 K	9805153221	
						1210	4000 K	9805153921	

ULTRA SLIM - 24V - L 1cm - IP54



DIMENSIONE E TAGLIO DIMENSION AND CUT	LED/m LED/m	OUTPUT (lm/W)	WATT (W/m)	IP IP	CRI CRI	LUMEN (lm/m)	CCT CCT	CODICE CODE	RIF. ENERGETICO ENERGY LABEL
EXTRA SLIM - ONLY 4,00 mm LARGE									
 4 X 2 mm ✂ 33 mm	204	85	14,4	54	90	1175	2700 K	9804152751	
						1225	3000 K	9804153051	
						1275	4000 K	9804154251	

Temperatura +/- 100 K - 3 step MacAdam / Temperature +/- 100 K - 3 MacAdam steps

LOW POWER - 24V - L 5m - IP20



DIMENSIONE E TAGLIO DIMENSION AND CUT	LED/m LED/m	OUTPUT (lm/W)	WATT (W/m)	IP IP	CRI CRI	LUMEN (lm/m)	CCT CCT	CODICE CODE	RIF. ENERGETICO ENERGY LABEL
 10 X 2 mm ✂ 50 mm	140	105	6	20	90	770	2700 K	9824LP2720	
						800	3000 K	9824LP3020	
						840	4000 K	9824LP4220	

LOW POWER - 24V - L 5m - IP65



DIMENSIONE E TAGLIO DIMENSION AND CUT	LED/m LED/m	OUTPUT (lm/W)	WATT (W/m)	IP IP	CRI CRI	LUMEN (lm/m)	CCT CCT	CODICE CODE	RIF. ENERGETICO ENERGY LABEL
 10 X 2 mm ✂ 50 mm	140	105	6	65	90	770	2700 K	98LP062765	
						800	3000 K	98LP063065	
						840	4000 K	98LP064265	

ULTRA SLIM - 24V - L 5m - IP20



DIMENSIONE E TAGLIO DIMENSION AND CUT	LED/m LED/m	OUTPUT (lm/W)	WATT (W/m)	IP IP	CRI CRI	LUMEN (lm/m)	CCT CCT	CODICE CODE	RIF. ENERGETICO ENERGY LABEL
 5 X 2 mm ✂ 50 mm	120	85	9,6	20	90	780	2700 K	9805102720	
						800	3000 K	9805103020	
						820	4000 K	9805104220	

 5 X 2 mm ✂ 33 mm	180	85	14,4	20	90	1170	2700 K	9805152720	
						1200	3000 K	9805153020	
						1230	4000 K	9805154220	

 5 X 2 mm ✂ 50 mm	120	85	9,6	20	95	770	2700 K	9805102920	
						790	3000 K	9805103220	
						810	4000 K	9805103920	

 5 X 2 mm ✂ 33 mm	180	85	14,4	20	95	1170	2700 K	9805152920	
						1190	3000 K	9805153220	
						1210	4000 K	9805153920	

ULTRA SLIM - 24V - L 5m - IP54



DIMENSIONE E TAGLIO DIMENSION AND CUT	LED/m LED/m	OUTPUT (lm/W)	WATT (W/m)	IP IP	CRI CRI	LUMEN (lm/m)	CCT CCT	CODICE CODE	RIF. ENERGETICO ENERGY LABEL
EXTRA SLIM - ONLY 4,00 mm LARGE									
 4 X 2 mm ✂ 33 mm	204	85	14,4	54	90	1175	2700 K	9804152754	
						1225	3000 K	9804153054	
						1275	4000 K	9804154254	

Temperatura +/- 100 K - 3 step MacAdam / Temperature +/- 100 K - 3 MacAdam steps

ULTRA SLIM HE - 24V - L 1cm - IP20



DIMENSIONE E TAGLIO DIMENSION AND CUT	LED/m LED/m	OUTPUT (lm/W)	WATT (W/m)	IP IP	CRI CRI	LUMEN (lm/m)	CCT CCT	CODICE CODE	RIF. ENERGETICO ENERGY LABEL
 5 X 2 mm ✂ 33 mm	168	158	12,0	20	90	1800	2700 K	9805122721	D
						1900	3000 K	9805123021	
						2000	4000 K	9805124221	
 5 X 2 mm ✂ 33 mm	180	105	14,4	20	90	1460	2700 K	98H5152721	F
						1510	3000 K	98H5153021	
						1560	4000 K	98H5154221	
CRI>97 - R9>90									
 5 X 2 mm ✂ 50 mm	160	138	12,0	20	97	1560	2700 K	9705122921	E
						1610	3000 K	9705123221	
						1660	4000 K	9705123921	
EXTRA SLIM - ONLY 4,00 mm LARGE									
 4 X 2 mm ✂ 33 mm	204	85	14,4	20	90	1175	2700 K	9804152721	G
						1225	3000 K	9804153021	
						1275	4000 K	9804154221	

ULTRA SLIM HE - 24V - L 1cm - IP54



DIMENSIONE E TAGLIO DIMENSION AND CUT	LED/m LED/m	OUTPUT (lm/W)	WATT (W/m)	IP IP	CRI CRI	LUMEN (lm/m)	CCT CCT	CODICE CODE	RIF. ENERGETICO ENERGY LABEL
 5 X 2 mm ✂ 33 mm	180	105	14,4	54	90	1460	2700 K	98H5152751	F
						1510	3000 K	98H5153051	
						1560	4000 K	98H5154251	

ULTRA SLIM HE - 24V - L 1cm - IP65



DIMENSIONE E TAGLIO DIMENSION AND CUT	LED/m LED/m	OUTPUT (lm/W)	WATT (W/m)	IP IP	CRI CRI	LUMEN (lm/m)	CCT CCT	CODICE CODE	RIF. ENERGETICO ENERGY LABEL
 5 X 2 mm ✂ 33 mm	168	150	12	65	90	1800	2700 K	9805122761	D
						1900	3000 K	9805123061	
						2000	4000 K	9805124261	

Temperatura +/- 100 K - 3 step MacAdam / Temperature +/- 100 K - 3 MacAdam steps

ULTRA SLIM HE - 24V - L 5m - IP20



DIMENSIONE E TAGLIO DIMENSION AND CUT	LED/m LED/m	OUTPUT (lm/W)	WATT (W/m)	IP IP	CRI CRI	LUMEN (lm/m)	CCT CCT	CODICE CODE	RIF. ENERGETICO ENERGY LABEL
 5 X 2 mm ✂ 33 mm	168	158	12,0	20	90	1800	2700 K	9805122720	D
						1900	3000 K	9805123020	
						2000	4000 K	9805124220	
 5 X 2 mm ✂ 33 mm	180	105	14,4	20	90	1460	2700 K	98H5152720	F
						1510	3000 K	98H5153020	
						1560	4000 K	98H5154220	
CRI>97 - R9>90									
 5 X 2 mm ✂ 50 mm	160	134	12,0	20	97	1560	2700 K	9705122920	E
						1610	3000 K	9705123220	
						1660	4000 K	9705123920	
EXTRA SLIM - ONLY 4,00 mm LARGE									
 4 X 2 mm ✂ 33 mm	204	85	14,4	20	90	1175	2700 K	9804152720	G
						1225	3000 K	9804153020	
						1275	4000 K	9804154220	

ULTRA SLIM HE - 24V - L 5m - IP54



DIMENSIONE E TAGLIO DIMENSION AND CUT	LED/m LED/m	OUTPUT (lm/W)	WATT (W/m)	IP IP	CRI CRI	LUMEN (lm/m)	CCT CCT	CODICE CODE	RIF. ENERGETICO ENERGY LABEL
 5 X 2 mm ✂ 33 mm	180	105	14,4	54	90	1460	2700 K	98H5152754	F
						1510	3000 K	98H5153054	
						1560	4000 K	98H5154254	

ULTRA SLIM HE - 24V - L 5m - IP65



DIMENSIONE E TAGLIO DIMENSION AND CUT	LED/m LED/m	OUTPUT (lm/W)	WATT (W/m)	IP IP	CRI CRI	LUMEN (lm/m)	CCT CCT	CODICE CODE	RIF. ENERGETICO ENERGY LABEL
 5 X 2 mm ✂ 33 mm	168	150	12	65	90	1800	2700 K	9805122765	D
						1900	3000 K	9805123065	
						2000	4000 K	9805124265	

Temperatura +/- 100 K - 3 step MacAdam / Temperature +/- 100 K - 3 MacAdam steps

led rgb
rgb ultraslim
led rgbw
led rgbtw
led tw

“cambiano colore a piacere dell'utenza”

RGB è l'acronimo inglese dei colori primari Red, Green, Blue, usati nei led per formare le varie tonalità di colore. A differenza dei led monocromatici, che emettono un solo colore (in genere il Bianco), i led RGB hanno la possibilità cambiare colore a piacere dell'utente con la frequenza decisa dallo stesso. Grazie a questa tecnologia, ogni ambiente potrà essere valorizzato al meglio con spettacolari giochi di luce, permettendo di creare una luce calda, morbida e diffusa, ma soprattutto di donare personalità anche al più impersonale degli spazi.

RGB is the English acronym for the primary colors Red, Green, Blue, used in the LEDs to form the various shades of color. Unlike monochromatic LEDs, which emit only one color (usually White), RGB LEDs have the ability to change color as desired by the user with the frequency decided by the user. Thanks to this technology, every environment can be enhanced to the best with spectacular plays of light, allowing you to create a warm, soft and diffused light, but above all to give personality to even the most impersonal of spaces.

led rgb + rgbw

designer

luigi cerbone



LED RGB - L 1cm - IP20



DIMENSIONE E TAGLIO DIMENSION AND CUT	LED/m LED/m	WATT (W/m)	IP IP	LUMEN (lm/m)	CCT CCT	CODICE CODE	RIF. ENERGETICO ENERGY LABEL
 10 X 2,5 mm ✂ 100 mm	336	14,4	20	960	RED GREEN BLUE	9924150021	
 10 X 2,5 mm ✂ 100 mm	60	14,4	20	960	RED GREEN BLUE	9924159921	

LED RGB - L 1cm - IP65



DIMENSIONE E TAGLIO DIMENSION AND CUT	LED/m LED/m	WATT (W/m)	IP IP	LUMEN (lm/m)	CCT CCT	CODICE CODE	RIF. ENERGETICO ENERGY LABEL
 10 X 2,5 mm ✂ 100 mm	60	14,4	65	960	RED GREEN BLUE	9924159961	



LED RGB - L 5m - IP20



DIMENSIONE E TAGLIO DIMENSION AND CUT	LED/m LED/m	WATT (W/m)	IP IP	LUMEN (lm/m)	CCT CCT	CODICE CODE	RIF. ENERGETICO ENERGY LABEL
 10 X 2,5 mm ✂ 100 mm	336	14,4	20	960	RED GREEN BLUE	9924150020	
 10 X 2,5 mm ✂ 100 mm	60	14,4	20	960	RED GREEN BLUE	9924159920	

LED RGB - L 5m - IP65



DIMENSIONE E TAGLIO DIMENSION AND CUT	LED/m LED/m	WATT (W/m)	IP IP	LUMEN (lm/m)	CCT CCT	CODICE CODE	RIF. ENERGETICO ENERGY LABEL
 10 X 2,5 mm ✂ 100 mm	60	14,4	65	960	RED GREEN BLUE	9924159960	

LED RGB ULTRASLIM - L 1cm - IP20



DIMENSIONE E TAGLIO DIMENSION AND CUT	LED/m LED/m	WATT (W/m)	IP IP	LUMEN (lm/m)	CCT CCT	CODICE CODE	RIF. ENERGETICO ENERGY LABEL
 5 X 2,5 mm ✂ 50 mm	120	12	20	515	RED GREEN BLUE	9905129921	

LED RGB ULTRASLIM - L 1cm - IP54



DIMENSIONE E TAGLIO DIMENSION AND CUT	LED/m LED/m	WATT (W/m)	IP IP	LUMEN (lm/m)	CCT CCT	CODICE CODE	RIF. ENERGETICO ENERGY LABEL
 5 X 2,5 mm ✂ 50 mm	120	12	54	515	RED GREEN BLUE	9905129951	

LED RGB ULTRASLIM - L 5m - IP20



DIMENSIONE E TAGLIO DIMENSION AND CUT	LED/m LED/m	WATT (W/m)	IP IP	LUMEN (lm/m)	CCT CCT	CODICE CODE	RIF. ENERGETICO ENERGY LABEL
 5 X 2,5 mm ✂ 50 mm	120	12	20	515	RED GREEN BLUE	9905129920	

LED RGB ULTRASLIM - L 5m - IP54



DIMENSIONE E TAGLIO DIMENSION AND CUT	LED/m LED/m	WATT (W/m)	IP IP	LUMEN (lm/m)	CCT CCT	CODICE CODE	RIF. ENERGETICO ENERGY LABEL
 5 X 2,5 mm ✂ 50 mm	120	12	54	515	RED GREEN BLUE	9905129954	

LAVORAZIONI / PROCESSING

DATI TECNICI TECHNICAL DATA	CODICE CODE
CABLAGGIO - COLLAUDO - LED IP > 20 INSTALLATION AND TESTING LED >20	98RGBIP
CABLAGGIO - COLLAUDO - LED IP > 20 DOPPIA ALIMENTAZIONE INSTALLATION AND TESTING LED IP>20 POWER SUPPLY	98RGBIP2

LED RGBW - L 1cm - IP20



DIMENSIONE E TAGLIO DIMENSION AND CUT	LED/m LED/m	WATT (W/m)	IP IP	LUMEN (lm/m)	CCT CCT	CODICE CODE	RIF. ENERGETICO ENERGY LABEL
 10 X 2,5 mm ✂ 100 mm	60	14,4	20	880	RED GREEN BLUE 3000K - 3200K	9924159021	
 10 X 2,5 mm ✂ 100 mm	96	23	20	1390	RED GREEN BLUE 3000K - 3200K	9924239021	

LED RGBW - L 1cm - IP65



DIMENSIONE E TAGLIO DIMENSION AND CUT	LED/m LED/m	WATT (W/m)	IP IP	LUMEN (lm/m)	CCT CCT	CODICE CODE	RIF. ENERGETICO ENERGY LABEL
 10 X 2,5 mm ✂ 100 mm	60	14,4	65	880	RED GREEN BLUE 3000K - 3200K	9924159061	
 10 X 2,5 mm ✂ 100 mm	96	23	65	1390	RED GREEN BLUE 3000K - 3200K	9924239061	

LED RGB TUNABLE WHITE - L 1cm - IP20



DIMENSIONE E TAGLIO DIMENSION AND CUT	LED/m LED/m	WATT (W/m)	IP IP	LUMEN (lm/m)	CCT CCT	CODICE CODE	RIF. ENERGETICO ENERGY LABEL
 10 X 2,5 mm ✂ 100 mm	60	18	20	1200	RED GREEN BLUE 2700 K ↓ 6000*K	9924189021	

LAVORAZIONI / PROCESSING

DATI TECNICI
TECHNICAL DATACODICE
CODECABLAGGIO - COLLAUDO - LED IP > 20
INSTALLATION AND TESTING LED >20

98RGBIP

CABLAGGIO - COLLAUDO - LED IP > 20 DOPPIA ALIMENTAZIONE
INSTALLATION AND TESTING LED IP>20 POWER SUPPLY

98RGBIP2

LED RGBW - L 5m - IP20



DIMENSIONE E TAGLIO DIMENSION AND CUT	LED/m LED/m	WATT (W/m)	IP IP	LUMEN (lm/m)	CCT CCT	CODICE CODE	RIF. ENERGETICO ENERGY LABEL
 10 X 2,5 mm ✂ 100 mm	60	14,4	20	880	RED GREEN BLUE 3000K - 3200K	9924159020	
 10 X 2,5 mm ✂ 100 mm	96	23	20	1390	RED GREEN BLUE 3000K - 3200K	9924239020	

LED RGBW - L 5m - IP65



DIMENSIONE E TAGLIO DIMENSION AND CUT	LED/m LED/m	WATT (W/m)	IP IP	LUMEN (lm/m)	CCT CCT	CODICE CODE	RIF. ENERGETICO ENERGY LABEL
 10 X 2,5 mm ✂ 100 mm	60	14,4	65	880	RED GREEN BLUE 3000K - 3200K	9924159065	
 10 X 2,5 mm ✂ 100 mm	96	23	65	1390	RED GREEN BLUE 3000K - 3200K	9924239065	

LED RGB TUNABLE WHITE - L 5m - IP20



DIMENSIONE E TAGLIO DIMENSION AND CUT	LED/m LED/m	WATT (W/m)	IP IP	LUMEN (lm/m)	CCT CCT	CODICE CODE	RIF. ENERGETICO ENERGY LABEL
 10 X 2,5 mm ✂ 100 mm	60	18	20	1200	RED GREEN BLUE 2700 K ↓ 6000*K	9924189020	









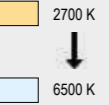

I led flessibili hanno numerose applicazioni limitate solo dalla fantasia di chi le impiega; grazie alla loro flessibilità è possibile creare dei veri e propri "percorsi di luce". Essi, possono essere impiegati sia per scopi estetici che come fonte di illuminazione vera e propria, soprattutto anche in ambienti dove è sufficiente una luce diffusa. Oggi la continua ricerca tecnologica ha reso disponibile una soluzione dove è possibile cambiare la tonalità della temperatura colore da 1800K a 6500K. Questa soluzione rende possibile la simulazione delle fasi solari all'interno degli ambienti, aumentando il benessere delle persone che li vivono.

Flexible LEDs have numerous applications limited only by the imagination of those who use them; thanks to their flexibility it is possible to create real "paths of light". They can be used both for aesthetic purposes and as a real lighting source, especially even in environments where diffused light is sufficient. Today, continuous technological research has made available a solution where it is possible to change the tone of the color temperature from 1800K to 6500K. This solution makes it possible to simulate the solar phases within the environments, increasing the well-being of the people who live there.



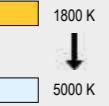





LED - L 5m - IP20

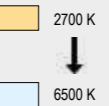

DIMENSIONE E TAGLIO DIMENSION AND CUT	LED/m LED/m	WATT (W/m)	IP IP	LUMEN (lm/m)	CCT CCT	CODICE CODE	RIF. ENERGETICO ENERGY LABEL
 10 X 2,5 mm  100 mm	60	19,2	20	1760	 2700 K ↓ 6500 K	9924196220	
 10 X 2,0 mm  50 mm	240	24	20	2000	 1800 K ↓ 5000 K	9924246220	

LED - L 1cm - IP20

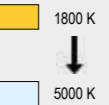

DIMENSIONE E TAGLIO DIMENSION AND CUT	LED/m LED/m	WATT (W/m)	IP IP	LUMEN (lm/m)	CCT CCT	CODICE CODE	RIF. ENERGETICO ENERGY LABEL
 10 X 2,5 mm  100 mm	60	19,2	20	1760	 2700 K ↓ 6500 K	9924196221	
 10 X 2,0 mm  50 mm	240	24	20	2000	 1800 K ↓ 5000 K	9924246221	

ACCESSORI / ACCESSORIES

CONTROLLER TOUCH + CENTRALINA / CONTROLLER TOUCH RGB + REMOTE CONTROL

DATI TECNICI
TECHNICAL DATA

POTENZA MASSIMA SUPPORTATA
SUPPORTED MAX POWER

CODICE
CODE

DIMENSIONI / DIMENSIONS: 83 x 82 x 32 mm
GRADO DI PROTEZIONE / PROTECTION DEGREE: IP20

LED RGB **432**
LED RGBW **576**
LED RGBTW **480**



9924010001
9924010003
9924114000

ARTICOLI INCLUSI NEL CODICE:
ARTICLES INCLUDED IN THE CODE:
- Centralina / Remote control
- Controller touch RGB

CONTROLLER TOUCH RGB A PARETE / TOUCH PANEL RGB

DATI TECNICI
TECHNICAL DATA

POTENZA MASSIMA SUPPORTATA
SUPPORTED MAX POWER

CODICE
CODE

CONTROLLER TOUCH RGB A PARETE
TOUCH PANEL RGB

288

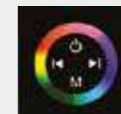

9924010002

DIMENSIONI / DIMENSIONS: 86 x 86 x 34 mm
GRADO DI PROTEZIONE / PROTECTION DEGREE: IP20

SCATOLA DA INCASSO A PARETE PER TOUCH PANEL RGB / INSTALLATION BOX FOR TOUCH PANEL RGB

DATI TECNICI
TECHNICAL DATA

CODICE
CODE

DIMENSIONI / DIMENSIONS: 86 x 86 x 34 mm
GRADO DI PROTEZIONE / PROTECTION DEGREE: IP20

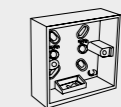

99002

driver 24V ip20

DATI TECNICI TECHNICAL DATA

Tensione/Voltage: 24V - CC SELV / 220-240v - 50-60 Hz
Power Factor > 0.9 at > 50% load
DC Operation 176-264v DC
Ambient Temperature: -15°C to 60°C
Weight: 0.20 - 1.50 Kg

DIMENSIONI (ln x lg x h) DIMENSIONS	POTENZA POWER	CODICE CODE
	10 W	980102
	30 W	980302
	35 W	980352
	75 W	980752
	90 W	980902
	96 W	980962
	120 W	981202
	180 W	981802

driver mA ip20

DATI TECNICI TECHNICAL DATA

Corrente: 700 mA - CC SELV / 220-240v - 50-60 Hz
Power Factor > 0.96 at
Operation 176-264v DC
Ambient Temperature: -15°C to 60°C
Weight: 0.20 - 1.50 Kg

DIMENSIONI (ln x lg x h) DIMENSIONS	POTENZA POWER	CODICE CODE
	10 W	980107
	15 W	980157
	32 W	980327

driver ip67

DATI TECNICI TECHNICAL DATA

Tensione/Voltage: 24V - CC SELV / 220-240v - 50-60 Hz
Power Factor > 0.9 at > 50% load
DC Operation 176-264v DC
Ambient Temperature: -15°C to 60°C
Weight: 0.20 - 1.50 Kg

DIMENSIONI (ln x lg x h) DIMENSIONS	POTENZA POWER	CODICE CODE
	30 W	980306
	75 W	980756
	100 W	981006
	150 W	981506
	200 W	982006
	240 W	982406
	320 W	983206
	480 W	9848D6
	600 W	9860D6

emergency driver

KIT DI EMERGENZA / EMERGENCY LIGHT KIT

DATI TECNICI TECHNICAL DATA	DIMENSIONI (ln x lg x h)mm DIMENSIONS	CODICE CODE
<p>VOLTAGE: 220-240V FREQUENCY: 50/60 Hz POWER: 30 W SUPPLY CURRENT: 20 mA OPERATING TIME: 1-3 h CHARGE TIME: 24 h ta °C: 0 / +60 tc °C: 80</p>		983010

SCHEMA DI COLLEGAMENTO / WIRING DIAGRAM

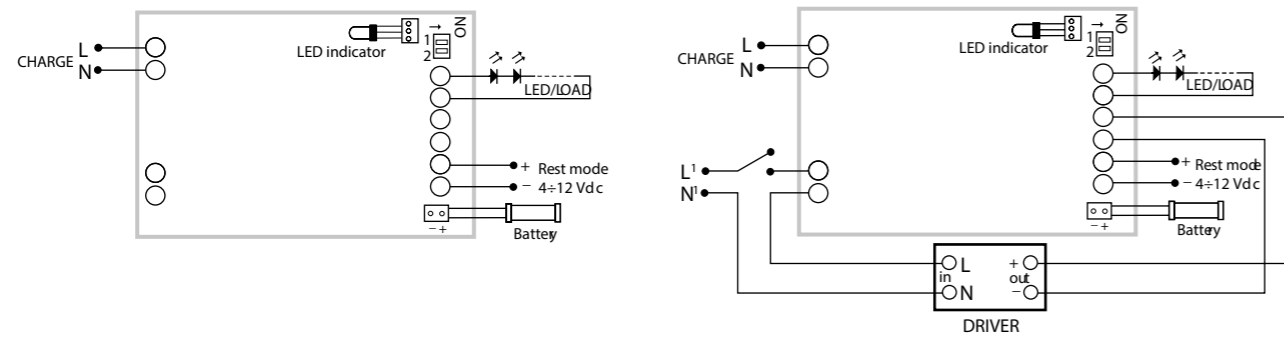

DIMMER

DATI TECNICI TECHNICAL DATA	DIMENSIONI (ln x lg x h) DIMENSIONS	POTENZA POWER	CODICE CODE
DIMMER 0-10 V 12-24V - 8A		200 W	98200V
DIMMER DALI PUSH / 1-10 V - 5A		120 W	98120D

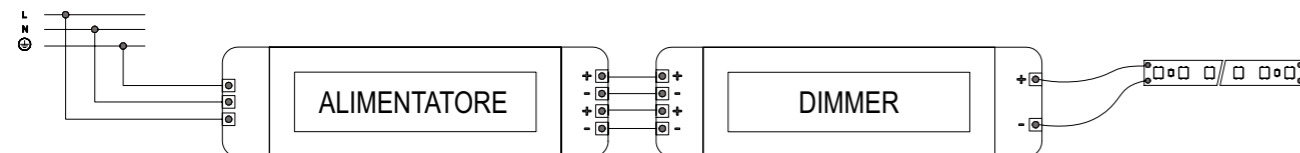

dimmer

DRIVER DIMMER DALI / SWITCH PUSH

DATI TECNICI TECHNICAL DATA	DIMENSIONI (ln x lg x h) DIMENSIONS	POTENZA POWER	CODICE CODE
<p>Tensione / Voltage: 24V - CC SELV / 220-240v - 50-60 Hz Dimmer da 1 a 100% Power Factor > 0.9 at > 50% load Ambient Temperature: -40°C to 80°C AC Voltage range 198-264v DC Voltage range 178-280v Efficiency 93% Weight: 0.30 - 0.80 Kg</p>		35 W	98035D
		60 W	98060D
		100 W	98100D
		150 W	98150D

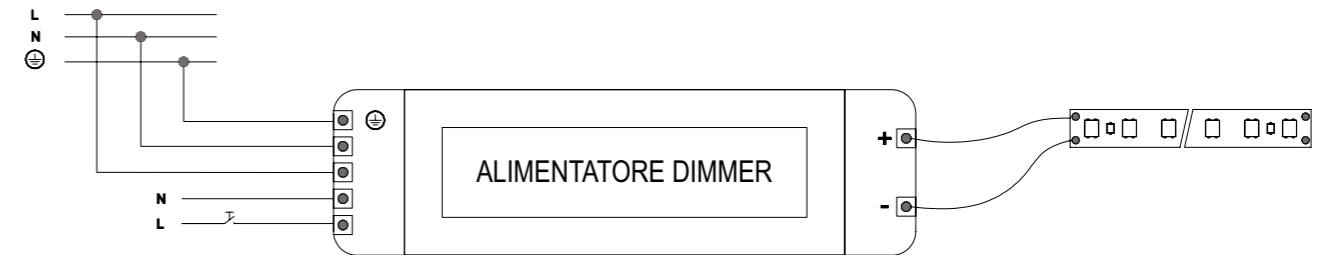

DRIVER DIMMER SLIM

DATI TECNICI TECHNICAL DATA	DIMENSIONI (ln x lg x h) DIMENSIONS	POTENZA POWER	CODICE CODE
<p>Tensione / Voltage: 24V - CC SELV / 220-240v - 50-60 Hz Dimmer da 1 a 100% Power Factor > 0.9 at > 50% load Ambient Temperature: -40°C to 80°C AC Voltage range 198-264v DC Voltage range 178-280v Efficiency 93% Weight: 0.30 - 0.80 Kg</p>		100 W	98101D

Dimming connection diagram

The DALI wiring diagram



The PUSH dimming wiring diagram

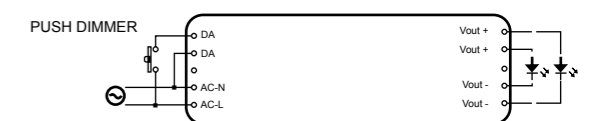

light control

SISTEMA DIMMER MASTER PER LED MONOCOLORE

DATI TECNICI TECHNICAL DATA MASTER	DIMENSIONI (ln x lg x h) DIMENSIONS	POTENZA POWER	CODICE CODE
<p>DIMMER CON RICEVITORE RADIO INTEGRATO PER IL COMANDO DI LED 1-COLORE 12/24 Vdc DIMMER WITH INTEGRATED RADIO RECEIVER FOR 1-COLOR 12/24 Vdc LED CONTROL</p> <p>- POSSIBILITA' DI COLLEGAMENTO DISPOSITIVI SLAVE (MAX 5) - CONTROLLO USCITE IN MODO INDIPENDENTE O SINCRONIZZATO - INGRESSO PER PULSANTI MANUALI - FUNZIONE LIGHT MEMORY - ACCENSIONE / SPEGNIMENTO LUCI GRADUALE - MEMORIZZAZIONE FINO A 42 TRASMETTITORI - CONFIGURAZIONE 4 SCENARI (solo se controllato con trasmettitore wireless 7 canali)</p> <p>ALIMENTAZIONE / SUPPLY: 12/24 Vdc NUMERO USCITE / EXIT NUMBER: 3 GRADO DI PROTEZIONE / DEGREE OF PROTECTION: IP20</p>	165 x 47 x 35 mm	50W PER USCITA (12Vdc) 100W PER USCITA (24Vdc)	98100N



SISTEMA DIMMER SLAVE PER LED MONOCOLORE

DATI TECNICI TECHNICAL DATA SLAVE	DIMENSIONI (ln x lg x h) DIMENSIONS	POTENZA POWER	CODICE CODE
<p>DIMMER SLAVE CON RICEVITORE RADIO INTEGRATO PER IL COMANDO DI LED 1-COLORE 12/24 Vdc DIMMER SLAVE WITH INTEGRATED RADIO RECEIVER FOR 1-COLOR 12/24 Vdc LED CONTROL</p> <p>- REPLICA LE FUNZIONI DEL MASTER (COD. 98100N)</p> <p>ALIMENTAZIONE / SUPPLY: 12/24 Vdc NUMERO USCITE / EXIT NUMBER: 3 GRADO DI PROTEZIONE / DEGREE OF PROTECTION: IP20</p>	165 x 47 x 35 mm	50W PER USCITA (12Vdc) 100W PER USCITA (24Vdc)	98100S

TRASMETTITORE RADIO 7 CANALI PER LED MONOCOLORE

DATI TECNICI TECHNICAL DATA	DIMENSIONI (ln x lg x h) DIMENSIONS	FINITURA FINISHES	CODICE CODE
<p>TRASMETTITORE 7 CANALI</p> <p>COMANDO RADIO 7 CANALI PER LED MONOCOLORE 7-CHANNEL RADIO CONTROL FOR ONE COLOR LED</p> <p>ALIMENTAZIONE / SUPPLY: 3V +/- 10% BATTERIA AL LITIO / LITHIUM BATTERY: CR2430 GRADO DI PROTEZIONE / DEGREE OF PROTECTION: IP20</p> <p>CLIP DI FISSAGGIO A PARETE INCLUSA WALL MOUNTING CLIP INCLUDED</p>	125 x 40 x 10 mm	<p>BIANCO/WHITE</p> <p>NERO/BLACK</p>	<p>980303</p> <p>980403</p>



TRASMETTITORE 4 LIVELLI DA PARETE PER LED MONOCOLORE

DATI TECNICI TECHNICAL DATA	DIMENSIONI (ln x lg x h) DIMENSIONS	FINITURA FINISHES	CODICE CODE
<p>TRASMETTITORE 4 LIVELLI COMANDO RADIO DA PARETE WALL RADIO CONTROL</p> <p>ALIMENTAZIONE / SUPPLY: 3V +/- 10% BATTERIA AL LITIO / LITHIUM BATTERY: CR2430 GRADO DI PROTEZIONE / DEGREE OF PROTECTION: IP20</p> <p>PLACCA IN POLICARBONATO POLYCARBONATE PLATE</p>	86 x 86 x 9,5 mm	<p>BIANCO/WHITE</p> <p>NERO/BLACK</p>	<p>980300</p> <p>980400</p>



light control

SISTEMA DIMMER MASTER PER LED RGB

DATI TECNICI TECHNICAL DATA MASTER	DIMENSIONI (ln x lg x h) DIMENSIONS	POTENZA POWER	CODICE CODE
<p>DIMMER CON RICEVITORE RADIO INTEGRATO PER IL COMANDO DI LED RGB 12/24 Vdc DIMMER WITH INTEGRATED RADIO RECEIVER FOR RGB 12/24 Vdc LED CONTROL</p> <p>- POSSIBILITA' DI COLLEGAMENTO DISPOSITIVI SLAVE (MAX 5) - CONTROLLO USCITE IN MODO INDIPENDENTE O SINCRONIZZATO - INGRESSO PER PULSANTI MANUALI - FUNZIONE LIGHT MEMORY - ACCENSIONE / SPEGNIMENTO LUCI GRADUALE - MEMORIZZAZIONE FINO A 42 TRASMETTITORI - RICHIAMO 8 COLORI PREDEFINITI + CICLO COLORI AUTOMATICO</p> <p>ALIMENTAZIONE / SUPPLY: 12/24 Vdc NUMERO USCITE / EXIT NUMBER: 3 GRADO DI PROTEZIONE / DEGREE OF PROTECTION: IP20</p>	165 x 47 x 35 mm	50W PER USCITA (12Vdc) 100W PER USCITA (24Vdc)	99100M



SISTEMA DIMMER SLAVE PER LED RGB

DATI TECNICI TECHNICAL DATA SLAVE	DIMENSIONI (ln x lg x h) DIMENSIONS	POTENZA POWER	CODICE CODE
<p>DIMMER SLAVE CON RICEVITORE RADIO INTEGRATO PER IL COMANDO DI LED RGB 12/24 Vdc DIMMER SLAVE WITH INTEGRATED RADIO RECEIVER FOR RGB 12/24 Vdc LED CONTROL</p> <p>- REPLICA LE FUNZIONI DEL MASTER (COD. 99100M)</p> <p>ALIMENTAZIONE / SUPPLY: 12/24 Vdc NUMERO USCITE / EXIT NUMBER: 3 GRADO DI PROTEZIONE / DEGREE OF PROTECTION: IP20</p>	165 x 47 x 35 mm	50W PER USCITA (12Vdc) 100W PER USCITA (24Vdc)	99100S

TRASMETTITORE RADIO 7 CANALI PER LED RGB

DATI TECNICI TECHNICAL DATA	DIMENSIONI (ln x lg x h) DIMENSIONS	FINITURA FINISHES	CODICE CODE
<p>TRASMETTITORE 7 CANALI</p> <p>COMANDO RADIO 7 CANALI PER LED RGB 7-CHANNEL RADIO CONTROL FOR RGB LED</p> <p>ALIMENTAZIONE / SUPPLY: 3V +/- 10% BATTERIA AL LITIO / LITHIUM BATTERY: CR2430 GRADO DI PROTEZIONE / DEGREE OF PROTECTION: IP20</p> <p>CLIP DI FISSAGGIO A PARETE INCLUSA WALL MOUNTING CLIP INCLUDED</p>	125 x 40 x 10 mm	BIANCO/WHITE	990302



light control

SISTEMA DIMMER MASTER PER LED RGBW

DATI TECNICI TECHNICAL DATA MASTER	DIMENSIONI (ln x lg x h) DIMENSIONS	POTENZA POWER	CODICE CODE
<p>DIMMER CON RICEVITORE RADIO INTEGRATO PER IL COMANDO DI LED RGBW 4 USCITE 12/24 Vdc DIMMER WITH INTEGRATED RADIO RECEIVER FOR RGBW 12/24 Vdc LED CONTROL</p> <p>- POSSIBILITA' DI COLLEGAMENTO DISPOSITIVI SLAVE (MAX 5) - USCITE RGB E BIANCO COMANDATE IN MODO INDIPENDENTE - COMANDO DA TRASMETTITORE O PULSANTI MANUALI - FUNZIONE LIGHT MEMORY - ACCENSIONE/SPEGNIMENTO LUCI GRADUALE - MEMORIZZAZIONE FINO A 42 TRASMETTITORI - RICHIAMO 8 COLORI + BIANCO + CICLO COLORI (solo con trasmettitore wireless 7 canali) - MODIFICA COLORI PREDEFINITI CON AGGIUNTA DEL BIANCO</p> <p>ALIMENTAZIONE / SUPPLY: 12/24 Vdc NUMERO USCITE / EXIT NUMBER: 4 GRADO DI PROTEZIONE / DEGREE OF PROTECTION: IP20</p>	165 x 47 x 35 mm	30W PER USCITA (12Vdc) 60W PER USCITA (24Vdc)	9960M



SISTEMA DIMMER SLAVE PER LED RGBW

DATI TECNICI TECHNICAL DATA SLAVE	DIMENSIONI (ln x lg x h) DIMENSIONS	POTENZA POWER	CODICE CODE
<p>DIMMER SLAVE CON RICEVITORE RADIO INTEGRATO PER IL COMANDO DI LED RGBW 12/24 Vdc DIMMER SLAVE WITH INTEGRATED RADIO RECEIVER FOR RGBW 12/24 Vdc LED CONTROL</p> <p>- REPLICA LE FUNZIONI DEL MASTER (COD. 9960M)</p> <p>ALIMENTAZIONE / SUPPLY: 12/24 Vdc NUMERO USCITE / EXIT NUMBER: 4 GRADO DI PROTEZIONE / DEGREE OF PROTECTION: IP20</p>	165 x 47 x 35 mm	30W PER USCITA (12Vdc) 60W PER USCITA (24Vdc)	9960S

TRASMETTITORE RADIO 7 CANALI PER LED RGBW

DATI TECNICI TECHNICAL DATA	DIMENSIONI (ln x lg x h) DIMENSIONS	FINITURA FINISHES	CODICE CODE
<p>TRASMETTITORE 7 CANALI</p> <p>COMANDO RADIO 7 CANALI PER LED RGBW 7-CHANNEL RADIO CONTROL FOR RGB LED</p> <p>ALIMENTAZIONE / SUPPLY: 3V +/- 10% BATTERIA AL LITIO / LITHIUM BATTERY: CR2430 GRADO DI PROTEZIONE / DEGREE OF PROTECTION: IP20</p> <p>CLIP DI FISSAGGIO A PARETE INCLUSA WALL MOUNTING CLIP INCLUDED</p>	125 x 40 x 10 mm	BIANCO/WHITE	990301



light control

INTERFACCIA DI CONTROLLO BLUETOOTH

DATI TECNICI TECHNICAL DATA	DIMENSIONI (ln x lg x h) DIMENSIONS	CODICE CODE
<p>INTERFACCIA BLUETOOTH PROGRAMMABILE DA APP PER IL CONTROLLO DEI DISPOSITIVI DI ILLUMINAZIONE BLUETOOTH INTERFACE, APP PROGRAMMABLE FOR THE CONTROL OF LIGHTING DEVICES</p> <p>- GESTIONE SINGOLA O A GRUPPI DEI DISPOSITIVI - CREAZIONE SCENARI - CONTROLLO DEI DISPOSITIVI DA PARTE DEL SINGOLO UTENTE</p> <p>ALIMENTAZIONE / SUPPLY: 230V GRADO DI PROTEZIONE / DEGREE OF PROTECTION: IP54</p> <p>ALIMENTAZIONE 230V INCLUSO POWER SUPPLY 230V INCLUDED</p> <p>COMPATIBILE CON SISTEMA ANDROID COMPATIBLE WITH ANDROID SYSTEM</p>	115 x 65 x 40 mm	99BLT



INTERFACCIA DI CONTROLLO WIRELESS

DATI TECNICI TECHNICAL DATA	DIMENSIONI (ln x lg x h) DIMENSIONS	CODICE CODE
<p>INTERFACCIA WIRELESS PROGRAMMABILE DA APP PER IL CONTROLLO DEI DISPOSITIVI DI ILLUMINAZIONE WIRELESS INTERFACE, APP PROGRAMMABLE FOR THE CONTROL OF LIGHTING DEVICES</p> <p>- GESTIONE SINGOLA O A GRUPPI DEI DISPOSITIVI - CREAZIONE SCENARI - POSSIBILITÀ DI COMUNICAZIONE A DISTANZA - CONTROLLO DEI DISPOSITIVI DA PARTE DI PIÙ UTENTI</p> <p>ALIMENTAZIONE / SUPPLY: 230V GRADO DI PROTEZIONE / DEGREE OF PROTECTION: IP54</p> <p>ALIMENTAZIONE 230V INCLUSO POWER SUPPLY 230V INCLUDED</p> <p>COMPATIBILE CON SISTEMA ANDROID COMPATIBLE WITH ANDROID SYSTEM</p>	115 x 65 x 40 mm	99APP



condizioni di vendita

Il committente accetta, nessuna esclusa, tutte le condizioni di vendita sotto indicate all'atto stesso in cui conferisce l'ordine anche se non esplicitamente dichiarata.

La presente pubblicazione annulla e sostituisce tutte le precedenti.

DESIGN LUCE SRLU si riserva la facoltà di sopprimere o apportare ai propri apparecchi ed accessori qualsiasi modifica che ritiene necessaria ai fini tecnici e commerciali o estetici senza darne preavviso. Le descrizioni e le dimensioni degli apparecchi riportate nei cataloghi e listini sono indicativi e non impegnativi.

ORDINI - CONFERME - TRASPORTO

Gli ordini dovranno essere trasmessi per iscritto da parte del committente o dai rappresentanti regolarmente nominati dalla DESIGN LUCE SRLU. Gli ordini telefonici dovranno essere confermati per iscritto, su carta intestata, da inviare all'apposito indirizzo mail.

La DESIGN LUCE SRLU si riserva il diritto di richiedere un anticipo sul pagamento totale della fornitura.

Per importi superiori a € 500,00 non saranno addebitate le spese di spedizione. Per ordini inferiori a € 500,00 sarà effettuata la consegna in porto franco con addebito di € 16,00. Per articoli con ingombri superiori ai 2,00m saranno addebitati ulteriori € 10,00.

Per gli articoli che richiedono imballi speciali in legno sarà previsto un addebito minimo di € 15,00 che sarà comunicato in conferma d'ordine. I termini di consegna saranno puramente indicativi. Il committente dovrà fornire i dati necessari e aver adempiuto a tutti gli obblighi nei confronti del fornitore nessuno escluso per permettere alla DESIGN LUCE SRLU di attivare le procedure interne ed emettere la conferma d'ordine con la data presunta di partenza della merce dagli stabilimenti. La DESIGN LUCE SRLU non accetta in nessun modo e per conto di nessuno ordini con consegna tassativa. I ritardi nelle consegne non danno diritto al committente a nessun risarcimento nè concede la facoltà parziale o totale di annullare, risolvere, rescindere il contratto d'acquisto. La merce viaggia sempre a rischio e pericolo del committente, indipendentemente dalle condizioni di resa. La DESIGN LUCE SRLU non risarcirà il committente per materiale danneggiato, rubato o manomesso durante il trasporto.

Il committente è tenuto alla verifica quantitativa

e qualitativa della merce all'atto della consegna ed è tenuto ad accettare sempre con RISERVA. I prezzi indicati nel presente listino sono al pubblico IVA ESCLUSA e potranno essere cambiati in qualsiasi momento dalla DESIGN LUCE SRLU che confermerà i prezzi indicati sull'ordine mediante conferma d'ordine inviata al committente.

RESI DI MATERIALE

I resi del materiale, inclusi quelli per merce difettosa in garanzia, dovranno essere preventivamente concordati per iscritto con la DESIGN LUCE SRLU che non accetterà materiale senza autorizzazione. Questo sarà respinto dal nostro reparto preposto. Il materiale dovrà essere recapitato al nostro reparto in porto franco: dopo accertamenti si provvederà alla sostituzione della merce o accredito. Nel caso di reso di materiale non difettoso non autorizzato saranno addebitati i costi di gestione pari al 25% del prezzo esposto in fattura all'atto dell'acquisto. Saranno accreditati solo i prodotti integri e con imballo originale, mentre gli articoli che non rispettano tali requisiti saranno rispediti al mittente. Non si accettano prodotti fuori dal listino in vigore.

GARANZIA

La garanzia sugli apparecchi è di 24 mesi, con decorrenza dalla data di consegna, per i difetti da attribuire alla fabbricazione. Sono esclusi dalla garanzia tutti i guasti causati da un uso improprio degli apparecchi e nel caso di manomissione dell'apparecchio da parte di terzi non autorizzati per iscritto dalla DESIGN LUCE SRLU. In nessun caso la DESIGN LUCE SRLU risarcirà i danni richiesti per la rimessa in opera del prodotto.

PAGAMENTI

I pagamenti dovranno pervenire presso la nostra sede o mediante personale da noi espressamente autorizzato secondo le modalità specificate in fase di registrazione del cliente presso la nostra banca dati. Il mancato pagamento autorizza la DESIGN LUCE SRLU a sospendere le forniture e saranno addebitati gli interessi di mora sullo scoperto. Per tutto quanto non citato nelle condizioni generali di compravendita sopra elencate, saranno applicate le norme sul contratto di compravendita con riferimento al Codice Civile della Repubblica Italiana. Per ogni controversia è competente il Foro di Firenze.

terms of sale

The client accepts, without exception, all the conditions of sale indicated below in the act in which he places the order, even if not explicitly declared.

This publication cancels and replaces all previous ones.

DESIGN LUCE SRLU reserves the right to cancel or make any modifications to its appliances and accessories that it deems necessary for technical and commercial or aesthetic purposes without giving prior notice. The descriptions and dimensions of the appliances shown in the catalogs and price lists are indicative and not binding.

ORDERS - CONFIRMATIONS - TRANSPORT

Orders must be sent in writing by the customer or by representatives regularly appointed by DESIGN LUCE SRLU. Telephone orders must be confirmed in writing, on headed paper, to be sent to the appropriate email address.

DESIGN LUCE SRLU reserves the right to request an advance on the total payment of the supply. For amounts over € 500.00 shipping costs will not be charged. For orders less than € 500.00 delivery will be made carriage paid with a charge of € 16.00. For items with dimensions greater than 2.00m additional € 10.00 will be charged.

For items requiring special wooden packaging there will be a minimum charge of € 15.00 which will be communicated in order confirmation.

Delivery terms will be purely indicative. The customer must provide the necessary data and have fulfilled all the obligations towards the supplier, none excluded to allow DESIGN LUCE SRLU to activate the internal procedures and issue the order confirmation with the presumed date of departure of the goods from the factories. DESIGN LUCE SRLU does not accept in any way and on behalf of anyone orders with mandatory delivery. Delays in deliveries do not entitle the customer to any compensation or grant partial or total right to cancel, terminate, terminate the purchase contract. The goods always travel at the risk and peril of the customer, regardless of the conditions of return. DESIGN LUCE SRLU will not compensate the customer for damaged, stolen or tampered with material during transport.

The customer is required to check the quantity and quality of the goods upon delivery and is required to always accept with RESERVE. The prices indicated in this price list are for the public EXCLUDING VAT and may be changed

at any time by DESIGN LUCE SRLU which will confirm the prices indicated on the order by order confirmation sent to the customer.

RETURNS OF MATERIAL

Returns of the material, including those for defective goods under warranty, must be agreed in advance in writing with DESIGN LUCE SRLU which will not accept material without authorization. This will be rejected by our department. The material must be delivered free of charge to our department: after inspections, the goods or credit will be replaced. In the case of unauthorized return of non-defective material, management costs equal to 25% of the price shown on the invoice at the time of purchase will be charged. Only intact products with original packaging will be credited, while items that do not meet these requirements will be sent back to the sender. Products outside the current price list are not accepted.

WARRANTY

The guarantee on the devices is 24 months, starting from the delivery date, for defects to be attributed to the manufacture. All faults caused by improper use of the appliances and in the case of tampering with the appliance by third parties not authorized in writing by DESIGN LUCE SRLU are excluded from the warranty. In no case the DESIGN LUCE SRLU will compensate the damages required for the re-installation of the product.

PAYMENTS

Payments must be received at our office or by personnel expressly authorized by us in the manner specified when registering the customer with our database. Failure to pay authorizes DESIGN LUCE SRLU to suspend supplies and interest for late payment will be charged. For everything not mentioned in the general conditions of sale listed above, the rules on the sale contract will be applied with reference to the Italian Civil Code. The Court of Florence is competent for any controversy.

energy labels

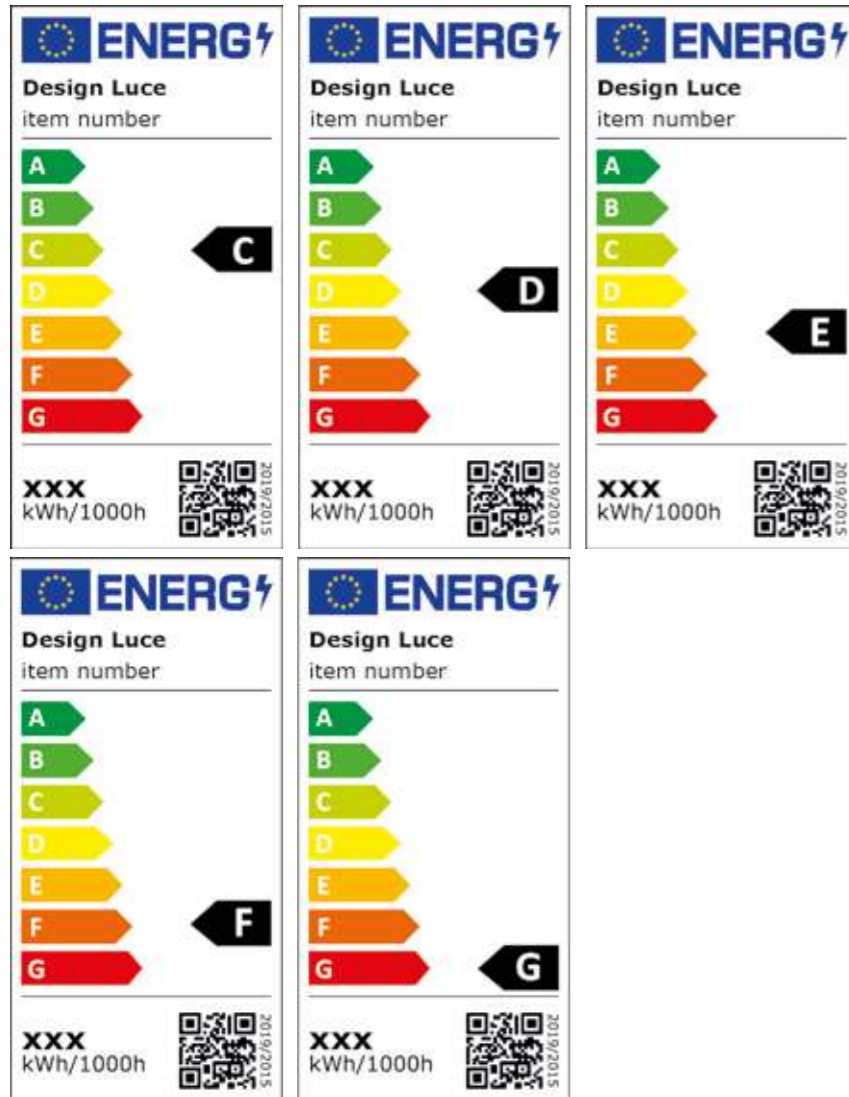

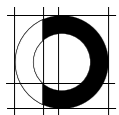

ART DIRECTION
Marco Ciarlo

PHOTOGRAPHY INTRO
Alice Ferrari

LAYOUT
Alice Ferrari
www.spazioblu.design

EDITING TEXT INTRO
Irene Salinas

EDITION
gennaio 2022 © all right reserved

DESIGN LUCE S.r.l.u via Bruno Storti 9/11, Sesto Fiorentino, Firenze (Italy)
[+39. 055 7223975](tel:+390557223975) | info@designluce.com | www.designluce.com |

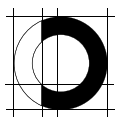

DESIGN
LUCE